

**Florentin Smarandache**

**Compiled and Solved Problems  
in Geometry and Trigonometry**



FLORENTIN SMARANDACHE

255 Compiled and Solved Problems  
in Geometry and Trigonometry

(from Romanian Textbooks)

Educational Publisher  
2015

*Peer reviewers:*

Prof. **Rajesh Singh**, School of Statistics, DAVV, Indore (M.P.), India.

Dr. **Linfan Mao**, Academy of Mathematics and Systems, Chinese Academy of Sciences, Beijing 100190, P. R. China.

**Mumtaz Ali**, Department of Mathematics, Quaid-i-Azam University, Islamabad, 44000, Pakistan

Prof. **Stefan Vladutescu**, University of Craiova, Romania.

**Said Broumi**, University of Hassan II Mohammedia, Hay El Baraka Ben M'sik, Casablanca B. P. 7951, Morocco.

*E-publishing, Translation & Editing:*

**Dana Petras, Nikos Vasiliou**

AdSumus Scientific and Cultural Society, Cantemir 13, Oradea, Romania

*Copyright:*

**Florentin Smarandache 1998-2015**

**Educational Publisher, Columbus, USA**

**ISBN: 978-1-59973-299-2**

## Table of Content

Explanatory Note .....	4
Problems in Geometry (9 <sup>th</sup> grade) .....	5
Solutions .....	11
Problems in Geometry and Trigonometry .....	38
Solutions .....	42
Other Problems in Geometry and Trigonometry (10 <sup>th</sup> grade) .....	60
Solutions .....	67
Various Problems.....	96
Solutions .....	99
Problems in Spatial Geometry .....	108
Solutions .....	114
Lines and Planes .....	140
Solutions .....	143
Projections .....	155
Solutions .....	159
Review Problems.....	174
Solutions .....	182

## Explanatory Note

This book is a translation from Romanian of "Probleme Compilate și Rezolvate de Geometrie și Trigonometrie" (University of Kishinev Press, Kishinev, 169 p., 1998), and includes problems of 2D and 3D Euclidean geometry plus trigonometry, compiled and solved from the Romanian Textbooks for 9th and 10th grade students, in the period 1981-1988, when I was a professor of mathematics at the "Petrașe Poenaru" National College in Balcești, Valcea (Romania), Lycée Sidi El Hassan Lyoussi in Sefrou (Morocco), then at the "Nicolae Balcescu" National College in Craiova and Dragotesti General School (Romania), but also I did intensive private tutoring for students preparing their university entrance examination. After that, I have escaped in Turkey in September 1988 and lived in a political refugee camp in Istanbul and Ankara, and in March 1990 I immigrated to United States. The degree of difficulties of the problems is from easy and medium to hard. The solutions of the problems are at the end of each chapter. One can navigate back and forth from the text of the problem to its solution using bookmarks. The book is especially a didactical material for the mathematical students and instructors.

The Author

## Problems in Geometry (9<sup>th</sup> grade)

1. The measure of a regular polygon's interior angle is four times bigger than the measure of its external angle. How many sides does the polygon have?

[Solution to Problem 1](#)

2. How many sides does a convex polygon have if all its external angles are obtuse?

[Solution to Problem 2](#)

3. Show that in a convex quadrilateral the bisector of two consecutive angles forms an angle whose measure is equal to half the sum of the measures of the other two angles.

[Solution to Problem 3](#)

4. Show that the surface of a convex pentagon can be decomposed into two quadrilateral surfaces.

[Solution to Problem 4](#)

5. What is the minimum number of quadrilateral surfaces in which a convex polygon with 9, 10, 11 vertices can be decomposed?

[Solution to Problem 5](#)

6. If  $(\widehat{ABC}) \equiv (\widehat{A'B'C'})$ , then  $\exists$  bijective function  $f = (\widehat{ABC}) \rightarrow (\widehat{A'B'C'})$  such that for  $\forall 2$  points  $P, Q \in (\widehat{ABC})$ ,  $\|PQ\| = \|f(P)\|, \|f(Q)\|$ , and vice versa.

[Solution to Problem 6](#)

7. If  $\Delta ABC \equiv \Delta A'B'C'$  then  $\exists$  bijective function  $f = ABC \rightarrow A'B'C'$  such that  
( $\forall$ ) 2 points  $P, Q \in ABC$ ,  $\|PQ\| = \|f(P)\|, \|f(Q)\|$ , and vice versa.

[Solution to Problem 7](#)

8. Show that if  $\Delta ABC \sim \Delta A'B'C'$ , then  $[ABC] \sim [A'B'C']$ .

[Solution to Problem 8](#)

9. Show that any two rays are congruent sets. The same property for lines.

[Solution to Problem 9](#)

10. Show that two disks with the same radius are congruent sets.

[Solution to Problem 10](#)

11. If the function  $f: M \rightarrow M'$  is isometric, then the inverse function  $f^{-1}: M' \rightarrow M$  is as well isometric.

[Solution to Problem 11](#)

12. If the convex polygons  $L = P_1, P_2, \dots, P_n$  and  $L' = P'_1, P'_2, \dots, P'_n$  have  $|P_i, P_{i+1}| \equiv |P'_i, P'_{i+1}|$  for  $i = 1, 2, \dots, n - 1$ , and  $P_i P_{i+1} \widehat{P_{i+2}} \equiv P'_i P'_{i+1} \widehat{P'_{i+2}}$ , ( $\forall$ )  $i = 1, 2, \dots, n - 2$ , then  $L \equiv L'$  and  $[L] \equiv [L']$ .

[Solution to Problem 12](#)

13. Prove that the ratio of the perimeters of two similar polygons is equal to their similarity ratio.

[Solution to Problem 13](#)

14. The parallelogram  $ABCD$  has  $\|AB\| = 6$ ,  $\|AC\| = 7$  and  $d(AC) = 2$ . Find  $d(D, AB)$ .

[Solution to Problem 14](#)

15. Of triangles  $ABC$  with  $\|BC\| = a$  and  $\|CA\| = b$ ,  $a$  and  $b$  being given numbers, find a triangle with maximum area.

[Solution to Problem 15](#)

16. Consider a square  $ABCD$  and points  $E, F, G, H, I, K, L, M$  that divide each side in three congruent segments. Show that  $PQRS$  is a square and its area is equal to  $\frac{2}{9}\sigma[ABCD]$ .

[Solution to Problem 16](#)

17. The diagonals of the trapezoid  $ABCD$  ( $AB\|DC$ ) cut at  $O$ .

- a. Show that the triangles  $AOD$  and  $BOC$  have the same area;
- b. The parallel through  $O$  to  $AB$  cuts  $AD$  and  $BC$  in  $M$  and  $N$ . Show that  $\|MO\| = \|ON\|$ .

[Solution to Problem 17](#)

18.  $E$  being the midpoint of the non-parallel side  $[AD]$  of the trapezoid  $ABCD$ , show that  $\sigma[ABCD] = 2\sigma[BCE]$ .

[Solution to Problem 18](#)

19. There are given an angle ( $\widehat{BAC}$ ) and a point  $D$  inside the angle. A line through  $D$  cuts the sides of the angle in  $M$  and  $N$ . Determine the line  $MN$  such that the area  $\Delta AMN$  to be minimal.

[Solution to Problem 19](#)

20. Construct a point  $P$  inside the triangle  $ABC$ , such that the triangles  $PAB$ ,  $PBC$ ,  $PCA$  have equal areas.

[Solution to Problem 20](#)

21. Decompose a triangular surface in three surfaces with the same area by parallels to one side of the triangle.

[Solution to Problem 21](#)



22. Solve the analogous problem for a trapezoid.

[Solution to Problem 22](#)

23. We extend the radii drawn to the peaks of an equilateral triangle inscribed in a circle  $L(O, r)$ , until the intersection with the circle passing through the peaks of a square circumscribed to the circle  $L(O, r)$ . Show that the points thus obtained are the peaks of a triangle with the same area as the hexagon inscribed in  $L(O, r)$ .

[Solution to Problem 23](#)

24. Prove the leg theorem with the help of areas.

[Solution to Problem 24](#)

25. Consider an equilateral  $\Delta ABC$  with  $\|AB\| = 2a$ . The area of the shaded surface determined by circles  $L(A, a), L(B, a), L(C, 3a)$  is equal to the area of the circle sector determined by the minor arc  $\widehat{EF}$  of the circle  $L(C, a)$ .

[Solution to Problem 25](#)

26. Show that the area of the *annulus* between circles  $L(O, r_1)$  and  $L(O, r_2)$  is equal to the area of a disk having as diameter the tangent segment to circle  $L(O, r_1)$  with endpoints on the circle  $L(O, r_2)$ .

[Solution to Problem 26](#)

27. Let  $[OA], [OB]$  two  $\perp$  radii of a circle centered at  $[O]$ . Take the points  $C$  and  $D$  on the minor arc  $\widehat{AB}$  such that  $\widehat{AC} \cong \widehat{BD}$  and let  $E, F$  be the projections of  $CD$  onto  $OB$ . Show that the area of the surface bounded by  $[DF], [FE], [EC]$  and arc  $\widehat{CD}$  is equal to the area of the sector determined by arc  $\widehat{CD}$  of the circle  $C(O, \|OA\|)$ .

[Solution to Problem 27](#)

28. Find the area of the regular octagon inscribed in a circle of radius  $r$ .

[Solution to Problem 28](#)

29. Using areas, show that the sum of the distances of a variable point inside the equilateral triangle  $ABC$  to its sides is constant.

[Solution to Problem 29](#)

30. Consider a given triangle  $ABC$  and a variable point  $M \in [BC]$ . Prove that between the distances  $x = d(M, AB)$  and  $y = d(M, AC)$  is a relation of  $kx + ly = 1$  type, where  $k$  and  $l$  are constant.

[Solution to Problem 30](#)

31. Let  $M$  and  $N$  be the midpoints of sides  $[BC]$  and  $[AD]$  of the convex quadrilateral  $ABCD$  and  $\{P\} = AM \cap BN$  and  $\{Q\} = CN \cap ND$ . Prove that the area of the quadrilateral  $PMQN$  is equal to the sum of the areas of triangles  $ABP$  and  $CDQ$ .

[Solution to Problem 31](#)

32. Construct a triangle having the same area as a given pentagon.

[Solution to Problem 32](#)

33. Construct a line that divides a convex quadrilateral surface in two parts with equal areas.

[Solution to Problem 33](#)

34. In a square of side  $l$ , the middle of each side is connected with the ends of the opposite side. Find the area of the interior convex octagon formed in this way.

[Solution to Problem 34](#)

35. The diagonal  $[BD]$  of parallelogram  $ABCD$  is divided by points  $M, N$ , in 3 segments. Prove that  $AMCN$  is a parallelogram and find the ratio between  $\sigma[AMCN]$  and  $\sigma[ABCD]$ .

[Solution to Problem 35](#)

36. There are given the points  $A, B, C, D$ , such that  $AB \cap CD = \{p\}$ . Find the locus of point  $M$  such that  $\sigma[ABM] = \sigma[CDM]$ .

[Solution to Problem 36](#)

37. Analogous problem for  $AB \parallel CD$ .

[Solution to Problem 37](#)

38. Let  $ABCD$  be a convex quadrilateral. Find the locus of point  $x_1$  inside  $ABCD$  such that  $\sigma[ABM] + \sigma[CDM] = k$ ,  $k$  – a constant. For which values of  $k$  the desired geometrical locus is not the empty set?

[Solution to Problem 38](#)

## Solutions

Solution to [Problem 1](#).



$$\frac{180(n-2)}{n} = 4 \frac{180}{5} \Rightarrow n = 10$$

Solution to [Problem 2](#).

$$\left. \begin{array}{l} \text{Let } n = 3 \\ x_1, x_2, x_3 \text{ ext} \end{array} \right\} \begin{array}{l} x_1 > 90^\circ \\ \Rightarrow x_2 > 90^\circ \\ x_3 > 90^\circ \end{array} \Rightarrow x_1 + x_2 + x_3 > 270^\circ, \text{ so } n = 3 \text{ is possible.}$$

$$\left. \begin{array}{l} \text{Let } n = 4 \\ x_1, x_2, x_3, x_4 \text{ ext} \end{array} \right\} \begin{array}{l} x_1 > 90^\circ \\ \vdots \\ x_3 > 90^\circ \end{array} \Rightarrow x_1 + x_2 + x_3 + x_4 > 360^\circ, \text{ so } n = 4 \text{ is impossible.}$$

Therefore,  $n = 3$ .

Solution to [Problem 3](#).

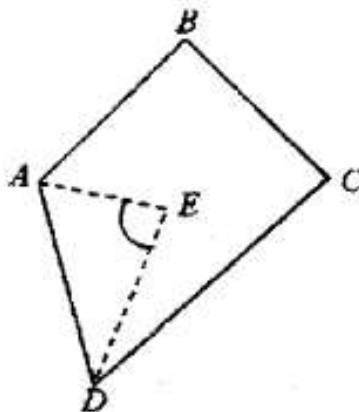

$$\begin{aligned}
 m(\widehat{AEB}) &= \frac{m(\widehat{D}) + m(\widehat{C})}{2} \\
 m(\widehat{A}) + m(\widehat{B}) + m(\widehat{C}) + m(\widehat{D}) &= 360^\circ \\
 \frac{m(\widehat{A}) + m(\widehat{B})}{2} &= 180^\circ - \frac{m(\widehat{C}) + m(\widehat{D})}{2} \\
 m(\widehat{AEB}) &= 180^\circ - \frac{m(\widehat{A})}{2} - \frac{m(\widehat{B})}{2} = \\
 &= 180^\circ - 180^\circ + \frac{m(\widehat{C}) + m(\widehat{D})}{2} = \frac{m(\widehat{C}) + m(\widehat{D})}{2}
 \end{aligned}$$

Solution to [Problem 4](#).

Let  $\widehat{EDC} \Rightarrow A, B \in \text{int. } \widehat{EDC}$ . Let  $M \in |AB| \Rightarrow M \in \text{int. } \widehat{EDC} \Rightarrow |DM \subset \text{int. } \widehat{EDC}, |EA| \cap |DM| = \emptyset \Rightarrow DEAM$  quadrilateral. The same for  $DCBM$ .

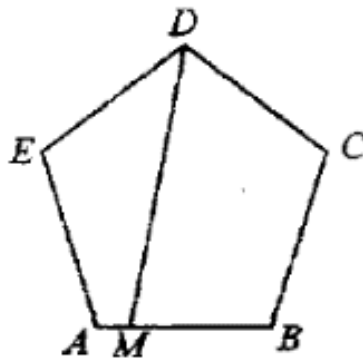

Solution to [Problem 5](#).

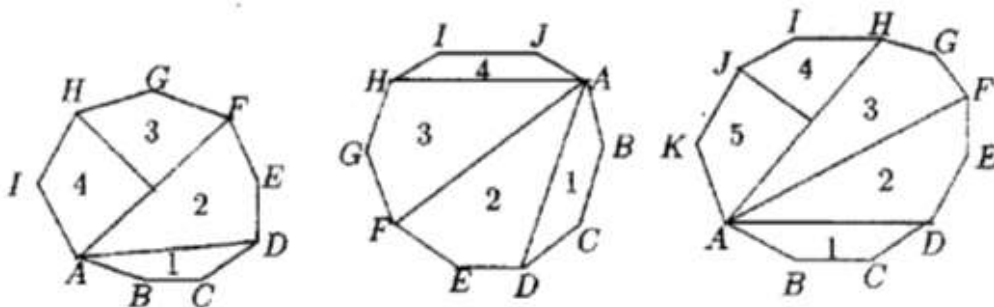

9 vertices;  
4 quadrilaterals.

10 vertices;  
4 quadrilaterals.

11 vertices;  
5 quadrilaterals.

Solution to [Problem 6](#).

We assume that  $\widehat{ABC} \cong \widehat{A'B'C'}$ . We construct a function  $f: \widehat{ABC} \rightarrow \widehat{A'B'C'}$  such that

$$\begin{cases} f(B) = B' \\ \text{if } P \in |BA, \quad f(P) \in B'A' \end{cases}$$

$$P \in |BC, f(P) \in B'C' \text{ such that } \|BP\| = \|B'P'\| \text{ where } P' = f(P).$$

The so constructed function is bijective, since for different arguments there are different corresponding values and  $\forall$  point from  $\widehat{A'B'C'}$  is the image of a single point from  $\widehat{ABC}$  (from the axiom of segment construction).

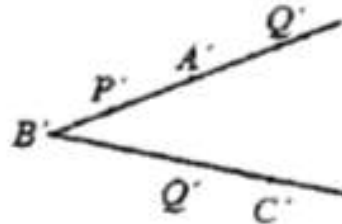
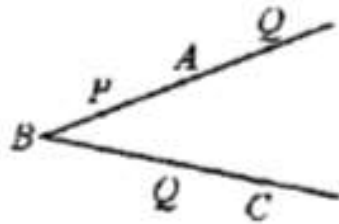

If  $P, Q \in$  this ray,

$$\begin{cases} \|BP\| = \|B'P'\| \\ \|BQ\| = \|B'Q'\| \end{cases} \Rightarrow \|PQ\| = \|BQ\| - \|BP\| = \|B'Q'\| - \|B'P'\| = \|P'Q'\| = \|f(P), f(Q)\|.$$

If  $P, Q \in$  a different ray,

$$\begin{cases} \|BP\| = \|B'P'\| \\ \|BQ\| = \|B'Q'\| \\ \widehat{PBQ} \cong \widehat{P'B'Q'} \end{cases} \Rightarrow \triangle PBQ = \triangle P'B'Q' \Rightarrow \|PQ\| = \|P'Q'\| = \|f(P), f(Q)\|.$$

*Vice versa.*

Let  $f: \widehat{ABC} \rightarrow \widehat{A'B'C'}$  such that  $f$  bijective and  $\|PQ\| = \|f(P), f(Q)\|$ .

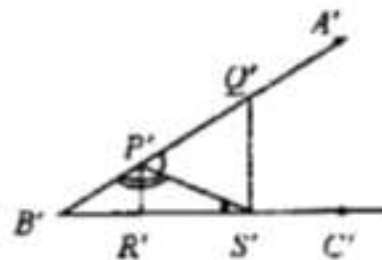
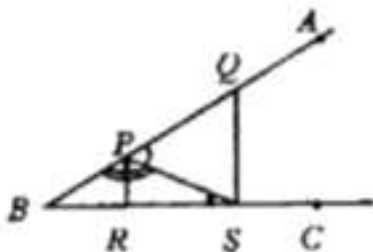

Let  $P, Q \in |BA$  and  $RS \in |BC$ .

$$\left. \begin{array}{l} \|PQ\| = \|P'Q'\| \\ \|PS\| = \|P'S'\| \\ \|QS\| = \|Q'S'\| \end{array} \right\} \Rightarrow \Delta PQS \equiv \Delta P'Q'S' \Rightarrow \widehat{QPS} \equiv \widehat{Q'P'S'} \Rightarrow \widehat{BPS} \equiv \widehat{B'P'S'} \quad (1);$$

$$\left. \begin{array}{l} \|PS\| = \|P'S'\| \\ \|RP\| = \|R'P'\| \\ \|PS\| = \|P'S'\| \end{array} \right\} \Rightarrow \Delta PRS \equiv \Delta P'R'S' \Rightarrow \widehat{PSB} \equiv \widehat{P'S'B'} \quad (2).$$

From (1) and (2)  $\Rightarrow \widehat{PBC} \equiv \widehat{P'B'S'}$  (as diff. at  $180^\circ$ ) i.e.  $\widehat{ABC} \equiv \widehat{A'B'C'}$ .

Solution to [Problem 7](#).

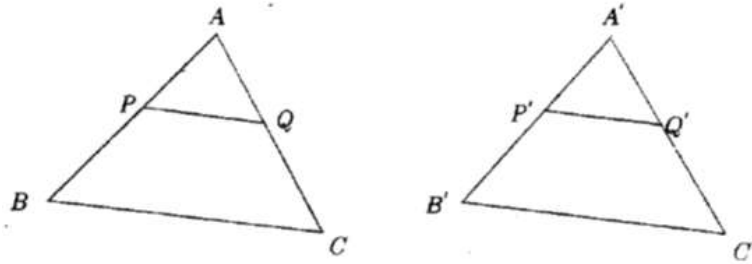

Let  $\Delta ABC \equiv \Delta A'B'C'$ .

We construct a function  $f : ABC \rightarrow A'B'C'$  such that  $f(A) = A', f(B) = B', f(C) = C'$  and so

$$P \in |AB| \rightarrow P' = f(P) \in |A'B'| \text{ such that } \|AP\| = \|A'P'\|;$$

$$P \in |BC| \rightarrow P' = f(P) \in |B'C'| \text{ such that } \|BP\| = \|B'P'\|;$$

$$P \in |CA| \rightarrow P' = f(P) \in |C'A'| \text{ such that } \|CP\| = \|C'P'\|.$$

The so constructed function is bijective.

Let  $P \in |AB|$  and  $Q \in |CA| \Rightarrow P' \in |A'B'|$  and  $Q' \in |C'A'|$ .

$$\left. \begin{array}{l} \|AP\| = \|A'P'\| \\ \|CQ\| = \|C'Q'\| \\ \|CA\| = \|C'A'\| \end{array} \right\} \Rightarrow \|AQ\| = \|A'Q'\|; A \equiv A' \Rightarrow \Delta APQ \equiv \Delta A'P'Q' \Rightarrow \|PQ\| = \|P'Q'\|.$$

Similar reasoning for  $(\forall)$  point  $P$  and  $Q$ .

*Vice versa.*

We assume that  $\exists$  a bijective function  $f : ABC \rightarrow A'B'C'$  with the stated properties.

We denote  $f(A) = A'', f(B) = B'', f(C) = C''$

$$\Rightarrow \|AB\| = \|A''B''\|, \|BC\| = \|B''C''\|, \|AC\| = \|A''C''\| \Rightarrow \Delta ABC = \Delta A''B''C''.$$

$$\begin{aligned} \text{Because } f(ABC) &= f([AB] \cup [BC] \cup [CA]) = f([AB]) \cup f([BC]) \cup f([CA]) \\ &= [A''B''] \cup [B''C''] \cup [C''A''] = A''B''C''. \end{aligned}$$

But by the hypothesis  $f(ABC) = f(A'B'C')$ , therefore

$$A''B''C'' = \Delta A'B'C' \Rightarrow \Delta ABC \equiv \Delta A'B'C'.$$

Solution to [Problem 8](#).

If  $\Delta ABC \sim \Delta A'B'C'$  then  $(\forall) f: ABC \rightarrow A'B'C'$  and  $k > 0$  such that:

$$||PQ|| = k ||f(P), f(Q)||, P, Q \in ABC;$$

$$\Delta ABC \sim \Delta A'B'C' \Rightarrow \left. \begin{aligned} \frac{||AB||}{||A'B'||} = \frac{||BC||}{||B'C'||} = \frac{||CA||}{||C'A'||} = k \\ \hat{A} \equiv \hat{A}'; \hat{B} \equiv \hat{B}'; \hat{C} \equiv \hat{C}' \end{aligned} \right\} \Rightarrow \begin{aligned} ||AB|| &= k||A'B'|| \\ ||BC|| &= k||B'C'|| \\ ||CA|| &= k||C'A'|| \end{aligned} .$$

We construct a function  $f: ABC \rightarrow A'B'C'$  such that  $f(A) = A', f(B) = B', f(C) = C'$ ;

if  $P \in |BC| \rightarrow P' \in |B'C'|$  such that  $||BP|| = k||B'P'||$ ;

if  $P \in |CA| \rightarrow P' \in |C'A'|$  such that  $||CP|| = k||C'P'||$ ;  $k$  – similarity constant.

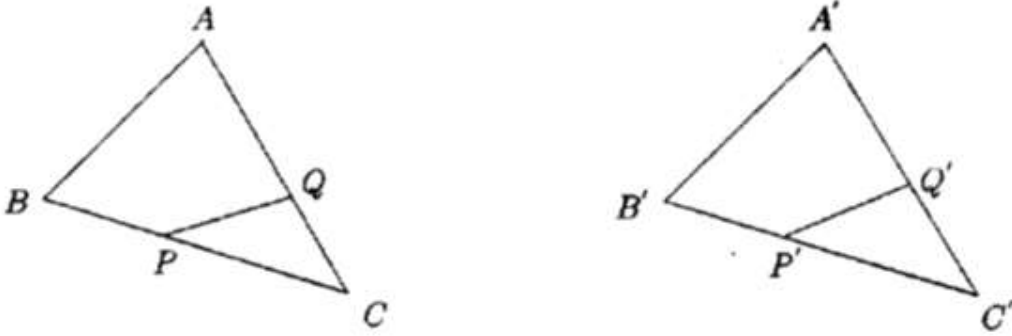

Let  $P, Q \in AB$  such that  $P \in |BC|, Q \in |AC| \Rightarrow P' \in |B'C'|$  and  $||BP|| = k||B'P'||$   
 $Q' \in |A'C'|$  and  $||CQ|| = k||C'Q'||$  (1);

$$\begin{aligned} \text{As } ||BC|| = k||B'C'|| \Rightarrow ||PC|| = ||BC|| - ||BP|| &= k||B'C'|| - k||B'P'|| = \\ &= k(||B'C'|| - ||B'P'||) = k||P'C'|| \text{ (2);} \end{aligned}$$

$$\hat{C} \equiv \hat{C}' \text{ (3).}$$

From (1), (2), and (3)  $\Rightarrow \Delta PCQ \sim \Delta P'C'Q' \Rightarrow ||PQ|| = k||P'Q' ||$  .

Similar reasoning for  $P, Q \in ABC$ .

We also extend the bijective function previously constructed to the interiors of the two triangles in the following way:

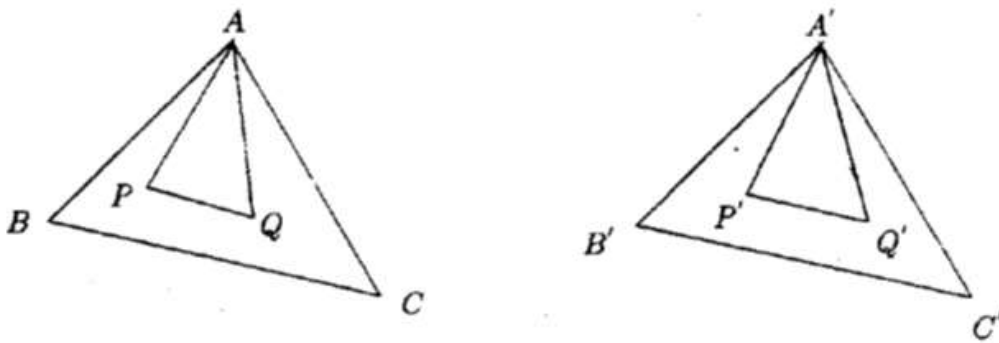

Let  $P \in \text{int.}ABC$  and we construct  $P' \in \text{int.}A'B'C'$  such that  $||AP|| = k||A'P'||$  (1).

Let  $Q \in \text{int.}ABC \rightarrow Q' \in \text{int.}A'B'C'$  such that  $\widehat{BAQ} \equiv \widehat{B'A'Q'}$  and  $||AQ|| = k||A'Q' ||$  (2).



From (1) and (2),

$$\frac{AP}{A'P'} = \frac{AQ}{A'Q'} = k, \widehat{PAQ} \equiv \widehat{P'A'Q'} \Rightarrow \Delta APQ \sim \Delta A'P'Q' \Rightarrow \|PQ\| = k\|P'Q'\|,$$

but  $P, Q \in [ABC]$ , so  $[ABC] \sim [A'B'C']$ .

Solution to [Problem 9](#).

a. Let  $|OA$  and  $|O'A'$  be two rays:

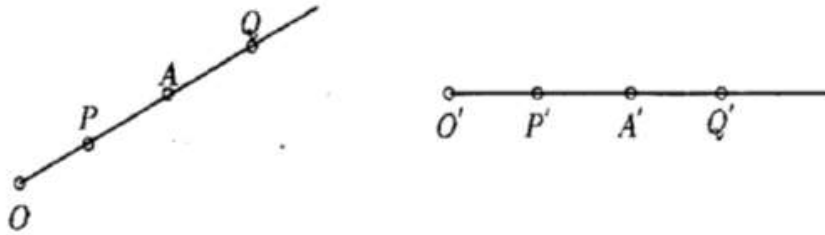

Let  $f: |OA \rightarrow |O'A'$  such that  $f(O) = O'$  and  $f(P) = P'$  with  $\|OP\| = \|O'P'\|$ .

The so constructed point  $P'$  is unique and so if  $P \neq Q \Rightarrow \|OP\| \neq \|OQ\| \Rightarrow \|O'P'\| \neq \|O'Q'\| \Rightarrow P' \neq Q'$  and  $(\forall)P' \in |O'A' (\exists)$  a single point  $P \in |OA$  such that  $\|OP\| = \|O'P'\|$ .

The constructed function is bijective.

If  $P, Q \in |OA, P \in |OQ| \rightarrow P'Q' \in |O'A'$  such that  $\|OP\| = \|O'P'\|; \|OQ\| = \|O'Q'\| \Rightarrow \|PQ\| = \|OQ\| - \|OP\| = \|O'Q'\| - \|O'P'\| = \|P'Q'\| (\forall)P, Q \in |OA$

$\Rightarrow$  the two rays are congruent.

b. Let  $d$  and  $d'$  be two lines.

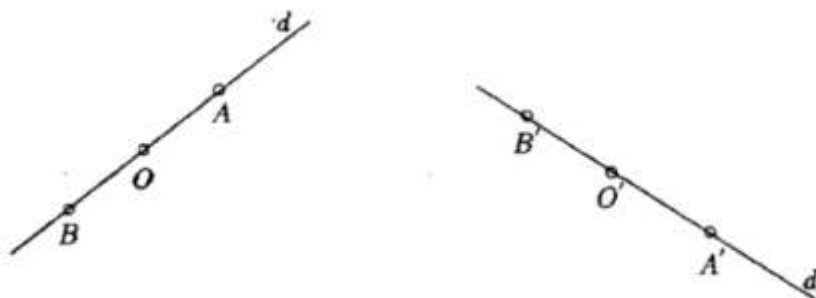

Let  $O \in d$  and  $O' \in d'$ . We construct a function  $f: d \rightarrow d'$  such that  $f(O) = O'$  and  $f(|OA) = |O'A'$  and  $f(|OB) = |O'B'$  as at the previous point.

It is proved in the same way that  $f$  is bijective and that  $\|PQ\| = \|P'Q'\|$  when  $P$  and  $Q$  belong to the same ray.

If  $P, Q$  belong to different rays:

$$\left. \begin{aligned} \|OP\| &= \|O'P'\| \\ \|OQ\| &= \|O'Q'\| \end{aligned} \right\} \Rightarrow \|PQ\| = \|OP\| + \|OQ\| = \|O'P'\| + \|O'Q'\| = \|P'Q'\|$$

and so the two rays are congruent.

Solution to [Problem 10](#).

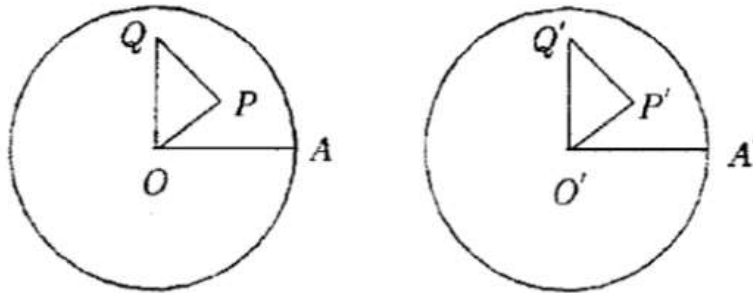

We construct a function  $f: D \rightarrow D'$  such that  $f(O) = O', f(A) = A'$  and a point  $(\forall) P \in D \rightarrow P' \in D'$  which are considered to be positive.

From the axiom of segment and angle construction  $\Rightarrow$  that the so constructed function is bijective, establishing a biunivocal correspondence between the elements of the two sets.

Let  $Q \in D \rightarrow Q' \in D'$  such that  $\|OQ'\| = \|OQ\|$ ;  $\widehat{AOQ} \equiv \widehat{A'O'Q'}$ .

As:

$$\left. \begin{aligned} \|OP\| &= \|O'P'\| \\ \|OQ\| &= \|O'Q'\| \\ \widehat{POQ} &\equiv \widehat{P'O'Q'} \end{aligned} \right\} \Rightarrow \triangle OPQ \equiv \triangle O'P'Q' \Rightarrow \|PQ\| = \|P'Q'\|, (\forall) P, Q \in D \Rightarrow D \equiv D'.$$

Solution to [Problem 11](#).

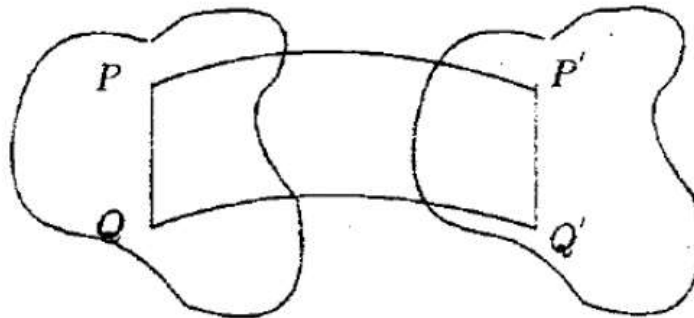

$f: M \rightarrow M'$  is an isometry  $\Rightarrow f$  is bijective and  $(\forall) P, Q \in M$  we have  $\|PQ\| = \|f(P), f(Q)\|$ ,  $f$  – bijective  $\Rightarrow f$  – invertible and  $f^{-1}$  – bijective.

$$\left. \begin{aligned} \|P'Q'\| &= \|f(P), f(Q)\| = \|PQ\| \\ \|f^{-1}(P'); f^{-1}(Q')\| &= \|f^{-1}(f(P)), f^{-1}(f(Q))\| = \|PQ\| \end{aligned} \right\} \Rightarrow$$

$$\|P'Q'\| = \|f^{-1}(f(P')), f^{-1}(f(Q'))\|, (\forall) P', Q' \in M,$$

therefore  $f^{-1}: M' \rightarrow M$  is an isometry.

Solution to [Problem 12](#).

We construct a function  $f$  such that  $f(P_i) = P'_i, i = 1, 2, \dots, n$ , and if  $P \in ]P_i, P_{i+1}[$ .



The previously constructed function is also extended inside the polygon as follows: Let  $O \in \text{int.} L \rightarrow O' \in \text{int.} L'$  such that  $\widehat{OP_i P_{i+1}} \equiv \widehat{O'P'_i P'_{i+1}}$  and  $\|OP_i\| = \|O'P'_i\|$ . We connect these points with the vertices of the polygon. It can be easily proved that the triangles thus obtained are congruent.

We construct the function  $g: [L] \rightarrow [L']$  such that

$$g(P) = \begin{cases} f(P), & \text{if } P \in L \\ O', & \text{if } P = O \\ P', & \text{if } P \in [P_i O P_{i+1}] \text{ such that} \\ & \widehat{P_i O P} \equiv \widehat{P'_i O' P'} \quad (\forall) i = 1, 2, \dots, n - 1 \end{cases}$$

The so constructed function is bijective  $(\forall) P, Q \in [L]$ . It can be proved by the congruence of the triangles  $POQ$  and  $P'O'Q'$  that  $\|PQ\| = \|P'Q'\|$ , so  $[L] = [L']$

*$\Rightarrow$  if two convex polygons are decomposed in the same number of triangles respectively congruent, they are congruent.*

Solution to [Problem 13](#).

$$L = P_1P_2 \dots, P_n; L' = P'_1P'_2 \dots, P'_n$$

$L \sim L' \Rightarrow (\exists)K > 0$  and  $f: L \rightarrow L'$  such that  $\|PQ\| = k\|f(P)f(Q)\| \ (\forall)P, Q \in L$ , and  $P'_i = f(P_i)$ .

Taking consecutively the peaks in the role of  $P$  and  $Q$ , we obtain:

$$\left. \begin{aligned} \|P_1P_2\| &= k\|P'_1P'_2\| \Rightarrow \frac{\|P_1P_2\|}{\|P'_1P'_2\|} = k \\ \|P_2P_3\| &= k\|P'_2P'_3\| \Rightarrow \frac{\|P_2P_3\|}{\|P'_2P'_3\|} = k \\ &\vdots \\ \|P_{n-1}P_n\| &= k\|P'_{n-1}P'_n\| \Rightarrow \frac{\|P_{n-1}P_n\|}{\|P'_{n-1}P'_n\|} = k \\ \|P_nP_1\| &= k\|P'_nP'_1\| \Rightarrow \frac{\|P_nP_1\|}{\|P'_nP'_1\|} = k \end{aligned} \right\} \Rightarrow$$

$$\Rightarrow k = \frac{\|P_1P_2\|}{\|P'_1P'_2\|} = \frac{\|P_2P_3\|}{\|P'_2P'_3\|} = \dots = \frac{\|P_1P_2\| + \|P_2P_3\| + \dots + \|P_{n-1}P_n\| + \|P_nP_1\|}{\|P'_1P'_2\| + \|P'_2P'_3\| + \dots + \|P'_{n-1}P'_n\| + \|P'_nP'_1\|} = \frac{P}{P'}$$

Solution to [Problem 14](#).

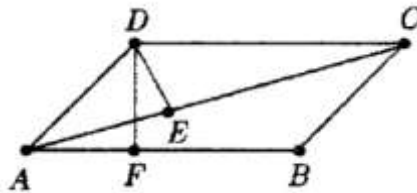

$$\sigma[ADC] = \frac{2 \cdot 7}{2} = 7; \sigma[ABCD] = 2 \cdot 7 = 14 = 6\|DF\| \Rightarrow \|DF\| = \frac{14}{6} = \frac{7}{3}$$

Solution to [Problem 15](#).

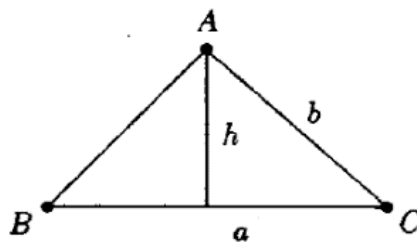

$$h = b \cdot \sin C \leq b;$$

$$\sigma[ABC] = \frac{a \cdot h}{2} \text{ is max. when } h \text{ is max.}$$

$$\text{max. } h = b \text{ when } \sin C = 1$$

$$\Rightarrow m(C) = 90 \Rightarrow ABC \text{ has a right angle at } C.$$

Solution to [Problem 16](#).

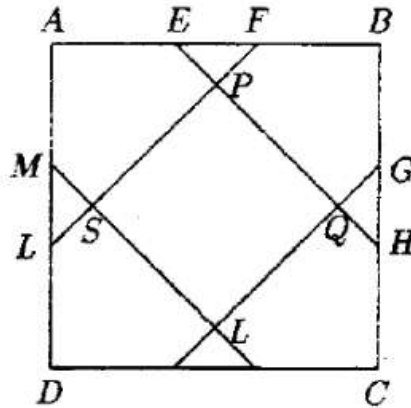

$$\|MD\| = \|DI\| \Rightarrow MDI - \text{an isosceles triangle.}$$

$$\Rightarrow m(\widehat{DMI}) = m(\widehat{MID}) = 45^\circ ;$$

$$\text{The same way, } m(\widehat{FLA}) = m(\widehat{AFL}) = m(\widehat{BEH}) = m(\widehat{EHB}).$$

$$\|RK\| \Rightarrow \|SP\| = \|PQ\| = \|QR\| = \|RS\| \Rightarrow SRQP \text{ is a square.}$$

$$\|AB\| = a, \|AE\| = \frac{2a}{3}, \|MI\| = \sqrt{\frac{4a^2}{9} + \frac{4a^2}{9}} = \frac{2a\sqrt{2}}{3};$$

$$2\|RI\|^2 = \frac{a^2}{9} \Rightarrow \|RI\|^2 = \frac{a^2}{18} \Rightarrow \|RI\| = \frac{a}{3\sqrt{2}} = \frac{a\sqrt{2}}{6};$$

$$\|SR\| = \frac{2a\sqrt{2}}{3} - 2 \frac{a\sqrt{2}}{6} = \frac{a\sqrt{2}}{3};$$

$$\sigma[SRQP] = \frac{2a^2}{9} = \frac{2}{9}\sigma[ABCD].$$

Solution to [Problem 17](#).

$$\left. \begin{aligned} \sigma[ACD] &= \frac{\|DC\| \cdot \|AE\|}{2} \\ \sigma[BCD] &= \frac{\|DC\| \cdot \|BF\|}{2} \\ \|AE\| &= \|BF\| \end{aligned} \right\} \Rightarrow \sigma[ACD] = \sigma[BCD]$$

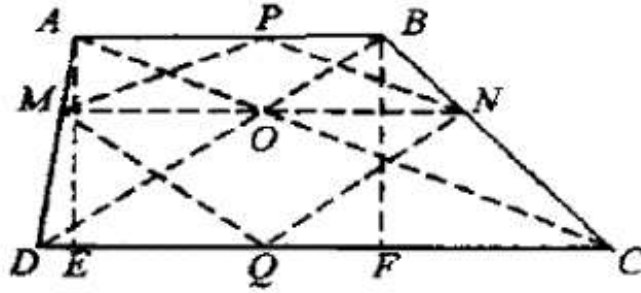

$$\left. \begin{aligned} \sigma[AOD] &= \sigma[AMO] + \sigma[MOD] \\ \sigma[AMO] &= \sigma[MPO] = \frac{\|MO\| \cdot \|OP\|}{2} \\ \sigma[MOD] &= \sigma[MOQ] = \frac{\|OM\| \cdot \|OQ\|}{2} \end{aligned} \right\} \Rightarrow \sigma[AOD] = \frac{\|OM\|(\|OP\| + \|OQ\|)}{2} = \frac{\|OM\| \cdot h}{2}$$

The same way,

$$\sigma[BOC] = \frac{\|ON\| \cdot h}{2}.$$

Therefore,

$$\sigma[AOD] = \sigma[BOC] \Rightarrow \frac{\|OM\| \cdot h}{2} = \frac{\|ON\| \cdot h}{2} \Rightarrow \|OM\| = \|ON\|.$$

Solution to [Problem 18](#).

$$\|AE\| = \|ED\| ;$$

We draw  $MN \perp AB; DC$ ;

$$\|EN\| = \|EM\| = \frac{h}{2};$$

$$\sigma[BEC] = \frac{(\|AB\| + \|DC\|) \cdot h}{2} - \frac{\|AB\| \cdot h}{4} - \frac{\|DC\| \cdot h}{4} = \frac{(\|AB\| + \|DC\|) \cdot h}{4} = \frac{1}{2}\sigma[ABCD];$$

Therefore,  $[ABCD] = 2\sigma[BEC]$  .

Solution to [Problem 19](#).

$\sigma[AEDN']$  is ct. because  $A, E, D, N'$  are fixed points.

Let a line through  $D$ , and we draw  $\parallel$  to sides  $ND$  and  $DE$ .

No matter how we draw a line through  $D$ ,  $\sigma[QPA]$  is formed of:  $\sigma[AEDN] + \sigma[NPO] + \sigma[DEQ]$ .

We have  $\sigma[AEDN]$  constant in all triangles  $PAQ$ .

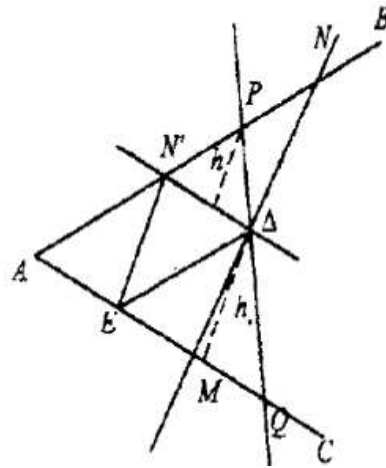

Let's analyse:

$$\begin{aligned} \sigma[PN'D] + \sigma[DEQ] &= \frac{\|N'D\| \cdot h_1}{2} + \frac{\|EQ'\| \cdot h_2}{2} = \frac{\|N'D\|}{2} \left( h_1 + \frac{\|EQ\|}{\|ND\|} \cdot h_2 \right) \\ &= \frac{\|N'D\|}{2} \cdot \left( h_1 + \frac{h_2}{h_1} \cdot h_2 \right) = \frac{\|N'D\|}{2h_1} [(h_1 - h_2)^2 + 2h_1h_2]. \end{aligned}$$

$\Delta AMN$  is minimal when  $h_1 = h_2 \Rightarrow D$  is in the middle of  $|PQ|$ . The construction is thus:  $\Delta ANM$  where  $NM \parallel EN'$ . In this case we have  $|ND| \equiv |DM|$ .

Solution to [Problem 20](#).

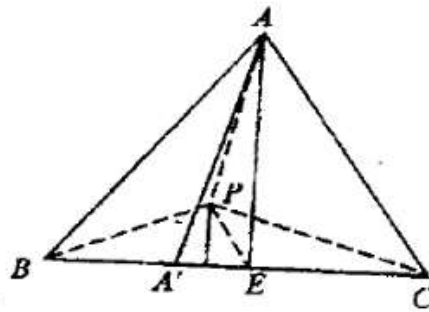

$$\sigma[ABC] = \frac{\|BC\| \cdot \|AA'\|}{2}$$

Let the median be  $|AE|$ , and  $P$  be the centroid of the triangle.

Let  $PD \perp BC$ .  $\sigma[BPC] = \frac{\|BC\| \cdot \|PD\|}{2}$ .

$$\left. \begin{array}{l} AA' \perp BC \\ PD \perp BC \end{array} \right\} \Rightarrow AA' \parallel PD \Rightarrow \Delta PDE \sim \Delta AA'E \Rightarrow \frac{\|PD\|}{\|AA'\|} = \frac{\|PE\|}{\|AE\|} = \frac{1}{3} \Rightarrow \|PD\| = \frac{\|AA'\|}{3} \Rightarrow \sigma[BPC]$$

$$= \frac{\|BC\| \cdot \frac{\|AA'\|}{3}}{2} = \frac{1}{3} \frac{\|BC\| \cdot \|AA'\|}{2} = \frac{1}{3} \sigma[ABC].$$

We prove in the same way that  $\sigma[PAC] = \sigma[PAB] = \frac{1}{3} \sigma[ABC]$ , so the specific point is the centroid.

Solution to [Problem 21](#).

Let  $M, N \in AB$  such that  $M \in |AN|$ .

We take  $MM' \parallel BC, MN' \parallel BC$ .

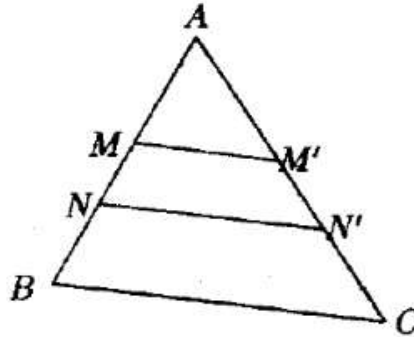

$$\Delta AMM' \sim \Delta ABC \Rightarrow \frac{\sigma[AMM']}{\sigma[ABC]} = \left(\frac{AM}{AB}\right)^2$$

$$\sigma[AMM'] = \frac{1}{3}\sigma, \left(\frac{\|AM\|}{\|AB\|}\right)^2 = \frac{1}{3}, \|AM\| = \frac{\|AB\|}{\sqrt{3}}; \Delta ANN' \sim \Delta ABC \Rightarrow$$

$$\left. \begin{array}{l} \frac{\sigma[ANN']}{\sigma[ABC]} = \left(\frac{\|AN\|}{\|AB\|}\right)^2 \\ \sigma[ANN'] = \frac{2}{3}\sigma[ABC] \end{array} \right\} \Rightarrow \left(\frac{\|AN\|}{\|AB\|}\right)^2 = \frac{2}{3} \Rightarrow \|AN\| = \sqrt{\frac{2}{3}}\|AB\|.$$

Solution to [Problem 22](#).

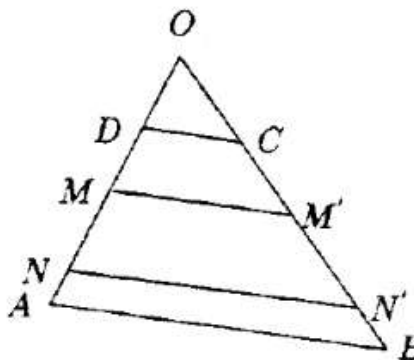

$$\|OD\| = a, \|OA\| = b;$$

$$\sigma[\Delta CMM'] = \sigma[MM'N'N] = \sigma[NN'BA] = \frac{1}{3}\sigma[ABCD];$$

$$\begin{aligned} \Delta ODC \sim \Delta OAB \Rightarrow \frac{\sigma[ODC]}{\sigma[OAB]} &= \frac{\|OD\|^2}{\|OA\|^2} = \frac{a^2}{b^2} \Rightarrow \frac{\sigma[ODC]}{\sigma[OAB] - \sigma[ODC]} = \frac{a^2}{b^2 - a^2} \Rightarrow \frac{\sigma[ODC]}{\sigma[ABCD]} \\ &= \frac{a^2}{b^2 - a^2} \quad (1) \end{aligned}$$



$$\begin{aligned} \Delta ODC \sim \Delta OMM' &\Rightarrow \frac{\sigma[ODC]}{\sigma[OMM']} = \left(\frac{\|OD\|}{\|OM\|}\right)^2 \Rightarrow \frac{\sigma[ODC]}{\sigma[OMM'] - \sigma[ODC]} = \frac{a^2}{\|OM\|^2} \\ &\Rightarrow \frac{\sigma[ODC]}{\sigma[DCMM']} = \frac{a^2}{\|OM\|^2 - a^2} \Rightarrow \frac{\sigma[ODC]}{\frac{1}{3}\sigma[ABCD]} = \frac{a^2}{\|OM\|^2 - a^2} \quad (2) \end{aligned}$$

$$\begin{aligned} \Delta ONN' \sim \Delta ODC &\Rightarrow \frac{\sigma[ODC]}{\sigma[DNN']} = \frac{\|OD\|}{\|ON\|} = \frac{a^2}{\|ON\|} \Rightarrow \frac{\sigma[ODC]}{\sigma[ONN'] - \sigma[ODC]} = \frac{a^2}{\|ON\|^2} \\ &\Rightarrow \frac{\sigma[ODC]}{\sigma[DCNN']} = \frac{a^2}{\|ON\|^2 - a^2} \Rightarrow \frac{\sigma[ODC]}{\frac{2}{3}\sigma[ABCD]} = \frac{a^2}{\|ON\|^2 - a^2} \quad (3) \end{aligned}$$

We divide (1) by (3):

$$\frac{2}{3} = \frac{\|ON\|^2 - a^2}{b^2 - a^2} \Rightarrow 3\|ON\|^2 - 3a^2 = 2b^2 - 2a^2 \Rightarrow \|ON\|^2 = \frac{a^2 + 2b^2}{3}.$$

Solution to [Problem 23](#).

$$\|OA\| = r \rightarrow \|DE\| = 2r; \sigma_{\text{hexagon}} = \frac{3r^2\sqrt{2}}{2} \quad (1)$$

$DEFO$  a square inscribed in the circle with radius  $R \Rightarrow$

$$\Rightarrow l_4 = R\sqrt{2} = \|DE\| \Rightarrow P\sqrt{2} = 2r \Rightarrow R = r\sqrt{2}$$

$$\|OM\| = R = r\sqrt{2}$$

$$\sigma[OMN] = \frac{\|OM\| \cdot \|ON\| \sin 120}{2} = \frac{r\sqrt{2} \cdot r\sqrt{2} \cdot \frac{\sqrt{3}}{2}}{2} = \frac{r^2\sqrt{3}}{2}$$

$$\sigma[MNP] = 3\sigma[OMN] = 3 \frac{r^2\sqrt{3}}{2} = \frac{3r^2\sqrt{3}}{2} \quad (2)$$

From (1) and (2)  $\Rightarrow \sigma[MNP] = \sigma_{\text{hexagon}}$ .

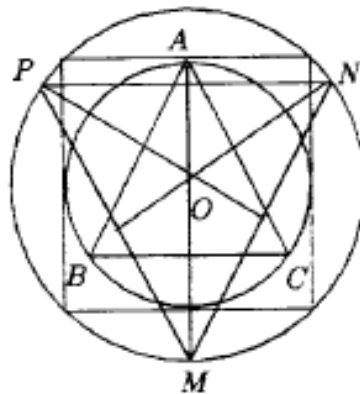

Solution to [Problem 24](#).

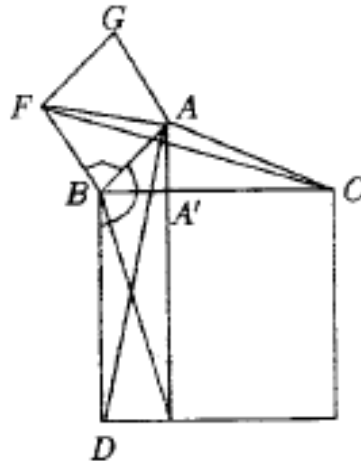

$$\|AB\|^2 = \|BC\| \cdot \|BA'\|$$

We construct the squares  $BCED$  on the hypotenuse and  $ABFG$  on the leg.

We draw  $AA' \perp BC$ .

$$\sigma[ABFG] = \|AB\|^2$$

$$\sigma[A'BDH] = \|BD\| \cdot \|BA'\| = \|BC\| \cdot \|BA'\| \dots$$

Solution to [Problem 25](#).

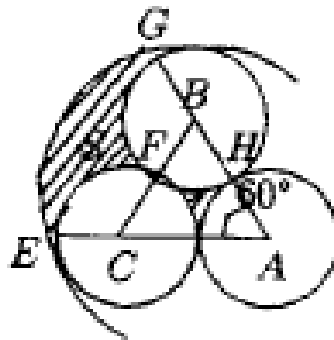

$$\sigma(s_1) = \sigma[ABC] - 3\sigma[\text{sect. } ADH]$$

$$\sigma[ABC] = \frac{l^2\sqrt{3}}{4} = \frac{(2a)^2\sqrt{3}}{4} = a^2\sqrt{3}$$

$$\sigma[\text{sect. } ADH] = \frac{r^2}{2} m(\widehat{DH})$$

$$m(\widehat{DH}) = \frac{\pi}{180} m(\widehat{DH}) = \frac{\pi}{180} \cdot 60^\circ = \frac{\pi}{3}$$

$$\sigma[\text{sect. } ADH] = \frac{a^2}{2} \cdot \frac{\pi}{3} = \frac{\pi a^2}{2}$$

$$\sigma(s_1) = a^2\sqrt{3} - 3 \frac{\pi a^2}{6} = a^2\sqrt{3} - \frac{\pi a^2}{2} \quad (1)$$

$$\begin{aligned}
 \sigma(s_2) &= \sigma[\text{sect. } AEG] - \sigma[\text{sect. } ABC] - \sigma[\text{sect. } ECF] - \sigma[\text{sect. } GBF] \\
 &= \frac{(3a)^2}{2} \cdot \frac{\pi}{180} \cdot 60 - a^2\sqrt{3} - \frac{a^2}{2} \cdot \frac{\pi}{180} \cdot 120 = \frac{9a^2}{2} \cdot \frac{\pi}{3} - a^2\sqrt{3} - \frac{\pi a^2}{3} - \frac{\pi a^2}{3} \\
 &= \frac{3\pi a^2}{2} - \frac{2\pi a^2}{3} - a^2\sqrt{3} \quad (2)
 \end{aligned}$$

From (1) and (2)

$$\Rightarrow \sigma(s_1) + \sigma(s_2) = \frac{3\pi a^2}{2} - \frac{2\pi a^2}{3} - \frac{\pi a^2}{2} = \frac{2\pi a^2}{6} = \frac{\pi a^2}{3}.$$

Solution to [Problem 26](#).

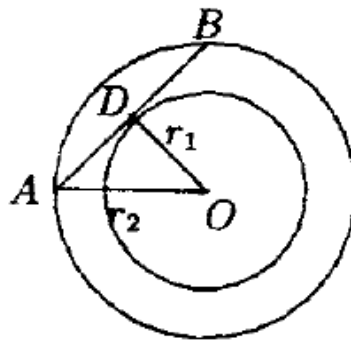

$$\|AD\|^2 = r_2^2 - r_1^2$$

$$\sigma[L(O, r_1)] = \pi r_1^2$$

$$\sigma[L(O, r_2)] = \pi r_2^2$$

$$\sigma[\text{annulus}] = \pi r_2^2 - \pi r_1^2 = \pi(r_2^2 - r_1^2) \quad (1)$$

$$\sigma[\text{disk diameter } \|AB\|] = \pi \|AD\|^2 = \pi(r_2^2 - r_1^2) \quad (2)$$

From (1) and (2)  $\Rightarrow \sigma[\text{annulus}] = \sigma[\text{disk diameter}]$ .

Solution to [Problem 27](#).

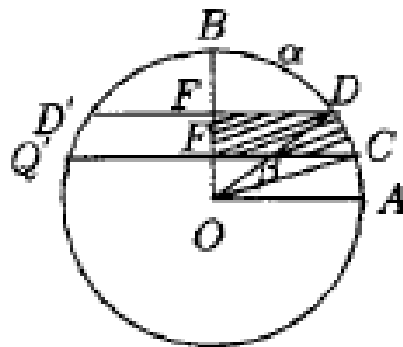

$$\sigma[CDEF] = \frac{\sigma[CDD'C']}{2}$$

$$\sigma[CDD'C'] = \sigma_{\text{seg}}[CDBD'C'] - \sigma_{\text{seg}}[DBD']$$

We denote  $m(\widehat{AC}) = m(\widehat{BD}) = \alpha \Rightarrow m(\widehat{CD}) = \frac{\pi}{2} - 2\alpha$

$$\sigma_{\text{sect.}} = \frac{r^2}{2}(\alpha - \sin \alpha)$$

$$\sigma[CDBD'C'] = \frac{r^2}{2}[\pi - 2\alpha - \sin(\pi - 2\alpha)] = \frac{r^2}{2}[\pi - 2\alpha - \sin(\pi - 2\alpha)]$$

$$\sigma_A = \frac{r^2}{2}(2\alpha - \sin 2\alpha)$$

$$\sigma[CDD'C'] = \sigma[CDBD'C'] - \sigma[DBD'] = \frac{r^2}{2}(\pi - 2\alpha - \sin 2\alpha) = \frac{r^2}{2}(2\alpha - \sin 2\alpha)$$

$$= \frac{r^2}{2}(\pi - 2\alpha - \sin 2\alpha - 2\alpha + \sin 2\alpha) = \frac{r^2}{2}(\pi - 4\alpha)$$

$$\Rightarrow \sigma[CDEF] = \frac{\sigma[CDD'C']}{2} = \frac{r^2}{4}(\pi - 4\alpha) = \frac{r^2}{2}\left(\frac{\pi}{2} - 2\alpha\right) \quad (1)$$

$$\sigma[\text{sect. } COD] = \frac{r^2}{2}m(\widehat{CD}) = \frac{r^2}{2}\left(\frac{\pi}{2} - 2\alpha\right) \quad (2)$$

From (1) and (2)  $\Rightarrow \sigma[CDEF] = \sigma[\text{sect. } COD]$ .

$$\|O_1F\| = \|OE\|$$

$$\sigma[\text{square}] = \|DE\|^2 = \|OA\|^2 = \frac{bc}{2} = V[ABC]$$

Solution to [Problem 28](#).

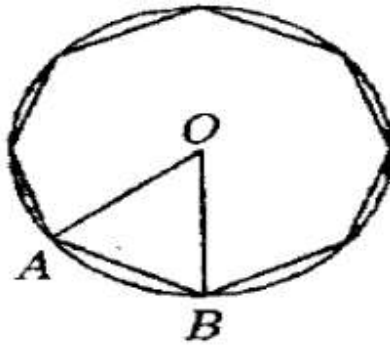

$$\mu(\widehat{AOB}) = \frac{\pi}{4}$$

$$\sigma[AOB] = \frac{r^2 \sin \frac{\pi}{4}}{2} = \frac{r^2 \frac{\sqrt{2}}{2}}{2} = \frac{r^2 \sqrt{2}}{4}$$

$$\sigma[\text{orthogon}] = 8 \cdot \frac{r^2 \sqrt{2}}{4} = 2\sqrt{2}r^2$$

Solution to [Problem 29](#).

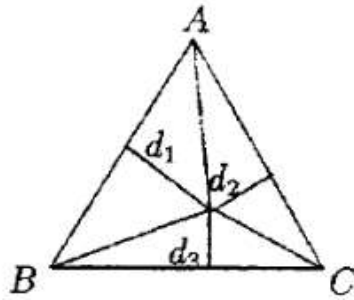

$$\begin{aligned} \sigma[ABC] &= \sigma[AMB] + \sigma[AMC] + \sigma[MBC] \\ \Rightarrow ah_a &= ad_3 + ad_2 + ad_1 \\ d_1 + d_2 + d_3 &= h_a \text{ (} a \text{ is the side of equilateral triangle)} \\ \Rightarrow d_1 + d_2 + d_3 &= \frac{a\sqrt{3}}{2} \text{ (because } h_a = \frac{a\sqrt{3}}{2} \text{)}. \end{aligned}$$

Solution to [Problem 30](#).

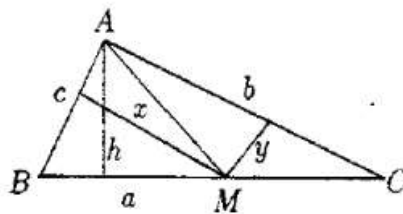

$$\begin{aligned} ABC - \text{given } \Delta &\Rightarrow a, b, c, h - \text{constant} \\ \sigma[ABC] &= \frac{ah}{2} \\ \sigma[ABC] &= \sigma[AMB] + \sigma[AMC] \\ \Rightarrow \frac{ah}{2} &= \frac{cx}{2} + \frac{by}{2} \Rightarrow cx + by = ah \Rightarrow \frac{c}{ah}x + \frac{b}{ah}y = 1 \Rightarrow kx + ly = 1, \\ \text{where } k &= \frac{c}{ah} \text{ and } l = \frac{b}{ah}. \end{aligned}$$

Solution to [Problem 31](#).

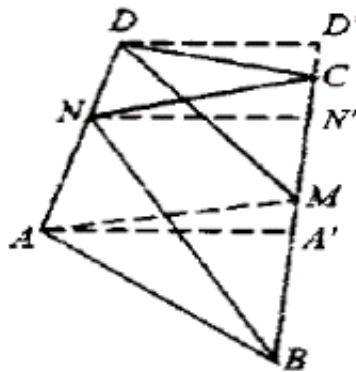

We draw  $AA' \perp BC; NN' \perp BC; DD' \perp BC \Rightarrow \left. \begin{array}{l} AA' \parallel NN' \parallel DD' \\ \|AN\| = \|ND\| \end{array} \right\} \Rightarrow MN'$  median line in the trapezoid  $AA'D'D \Rightarrow \|NN'\| = \frac{\|AA'\| + \|DD'\|}{2}, \sigma[BCN] = \frac{\|BC\| + \|NN'\|}{2}$ .

$$\sigma[BAM] + \sigma[MDC] = \frac{\|BM\| \cdot \|AA'\|}{2} + \frac{\|MC\| \cdot \|DD'\|}{2} \Rightarrow \|BM\| = \|MC\| = \frac{\|BC\|}{2} \Rightarrow$$

$$\Rightarrow \sigma[BAM] + \sigma[MDC] = \frac{\|BC\|}{2} \left( \frac{\|AA'\| + \|DD'\|}{2} \right) = \frac{\|BC\| \cdot \|NN'\|}{2} = \sigma[BCN]$$

$$\left. \begin{array}{l} \sigma[BCN] = \sigma[PMQN] + \sigma[BPM] + \sigma[MQC] \\ \sigma[BCN] + \sigma[MDC] = \sigma[BAP] + \sigma[BPM] + \sigma[MQC] + \sigma[CDQ] \end{array} \right\} \Rightarrow$$

$$\Rightarrow \sigma[PMQN] = \sigma[BPA] + \sigma[CDQ].$$

Solution to [Problem 32](#).

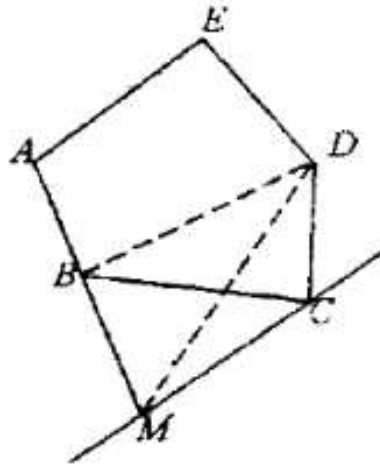

First, we construct a quadrilateral with the same area as the given pentagon. We draw through C a parallel to BD and extend  $|AB|$  until it intersects the parallel at M.

$$\sigma[ABCDE] = \sigma[ABDE] + \sigma[BCD],$$

$$\sigma[BCD] = \sigma[BDM] \text{ (have the vertices on a parallel at the base).}$$

$$\text{Therefore, } \sigma[ABCDE] = \sigma[AMDE].$$

Then, we consider a triangle with the same area as the quadrilateral  $AMDE$ .

We draw a parallel to  $AD$ ,  $N$  is an element of the intersection with the same parallel.

$$\sigma[AMDE] = \sigma[ADE] + \sigma[BDE] = \sigma[ADE] + \sigma[ADN] = \sigma[EDN].$$

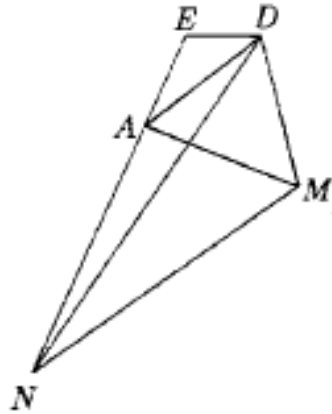

Solution to [Problem 33](#).

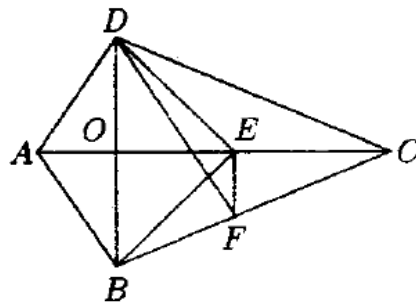

$$\|AE\| = \|EC\|$$

$$\|EF\| \parallel BD \Rightarrow \sigma[BDF] = \sigma[BDE]$$

$$\sigma[ABFD] = \sigma[ABED] \quad (1)$$

$\sigma[ADE] = \sigma[DEC]$  equal bases and the same height;

$$\sigma[ADE] = \sigma[DEC]$$

$$\sigma[ABED] = \sigma[BEDC] \quad (2)$$

$\sigma[DEF] = \sigma[BEF]$  the same base and the vertices on parallel lines at the base;

$$\sigma[DCF] \neq \sigma[DEC] + \sigma[ECF] + \sigma[DEF] \neq \sigma[DEC] + \sigma[ECF] + \sigma[BEF] = \sigma[BEDC] \quad (3)$$

$$(1), (2), (3) \Rightarrow \sigma[ABFD] = \sigma[DCF]$$

Solution to [Problem 34](#).

$$\left. \begin{array}{l} \triangle DCF \cong \triangle CBE \Rightarrow \widehat{CFD} \cong \widehat{CEB} \\ m(\widehat{CEB}) + m(\widehat{ECB}) = 90^\circ \end{array} \right\} \Rightarrow m(\widehat{CFN}) + m(\widehat{ECB}) = 90^\circ \Rightarrow \\ \Rightarrow m(\widehat{CNF}) = 90^\circ \Rightarrow CE \perp DF$$

$$\left. \begin{array}{l} |CF| \cong |EB| \\ m(\widehat{MBE}) = m(\widehat{NCF}) \\ m(\widehat{NEB}) + m(\widehat{CFN}) \end{array} \right\} \Rightarrow \triangle DCF \cong \triangle BME \Rightarrow \begin{array}{l} |CN| \cong |MB| \\ |NF| \cong |ME| \end{array}$$

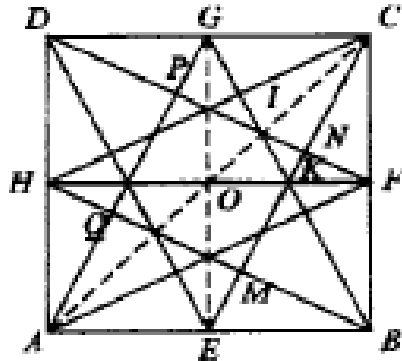

It is proved in the same way that:

$$\left. \begin{array}{l} |CN| \cong |NB| \cong |AQ| \cong |DP| \\ |NF| \cong |ME| \cong |NQ| \cong |PE| \\ |CE| \cong |NB| \cong |AG| \cong |DF| \end{array} \right\} \Rightarrow \\ \Rightarrow |PN| \cong |NM| \cong |QM| \cong |PQ|$$

$\Rightarrow MNPQ$  rhombus with right angle  $\Rightarrow MNPQ$  is a square.

$$\left. \begin{array}{l} |DG| \cong |FB| \\ \widehat{D\hat{I}G} \cong \widehat{F\hat{I}B} \\ \widehat{G\hat{D}I} \cong \widehat{F\hat{B}I} \end{array} \right\} \Rightarrow \triangle DGI \cong \triangle DFI \Rightarrow \begin{array}{l} |GI| \cong |FI| \\ |GC| \cong |CF| \\ |IC| \cong |IC| \text{ com.} \end{array} \right\} \Rightarrow \triangle GIC \cong \triangle FIC \Rightarrow \\ \Rightarrow \widehat{GCI} \cong \widehat{FCI} \Rightarrow I \in |AC|$$

It is proved in the same way that all the peaks of the octagon are elements of the axis of symmetry of the square, thus the octagon is regular.

$$\begin{aligned} \|CF\| &= \frac{1}{2}, \|RF\| = \frac{1}{4}, \|CR\| = \sqrt{\frac{1}{4} + \frac{1}{16}} = \frac{\sqrt{5}}{4} \\ \|NF\| \cdot \frac{\sqrt{5}}{4} &= \frac{1}{2} \cdot \frac{1}{4} = \frac{1}{8} \Rightarrow \|NF\| = \frac{1}{8} \cdot \frac{4}{\sqrt{5}} = \frac{1}{2\sqrt{5}} \\ \|EC\| &= \sqrt{\frac{1}{4} + 1} = \frac{\sqrt{5}}{2} \\ \|BM\| \cdot \frac{\sqrt{5}}{2} &= 1 \cdot \frac{1}{2} \Rightarrow \|BM\| = \frac{1}{\sqrt{5}} \\ \|MN\| &= \frac{\sqrt{5}}{2} - \frac{1}{2\sqrt{5}} - \frac{1}{\sqrt{5}} = \frac{5-1-2}{2\sqrt{5}} = \frac{1}{\sqrt{5}} \end{aligned}$$



Consider the square separately.

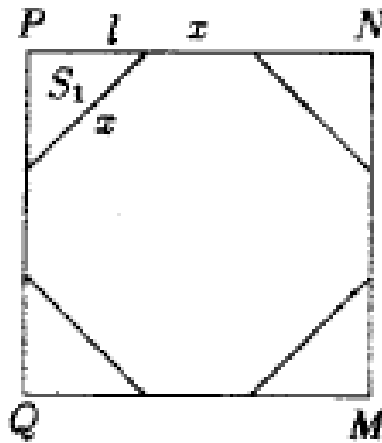

$$2l^2 = 2x^2$$

$$x = l\sqrt{2}$$

$$2l + l\sqrt{2} = \frac{1}{\sqrt{5}}$$

$$l(2 + \sqrt{2}) = \frac{1}{\sqrt{5}} \Rightarrow l = \frac{1}{\sqrt{5}(2 + \sqrt{2})}$$

$$\sigma[QMNP] = \frac{1}{5}$$

$$S_1 = \frac{x^2}{2}$$

$$\begin{aligned} S &= \sigma[QMNP] - 4S_1 = \frac{1}{5} - 2l^2 = \frac{1}{5} - 2 \frac{1}{5(6 + 4\sqrt{2})} = \frac{1}{5} - \frac{1}{5(3 + 2\sqrt{2})} = \\ &= \frac{1}{5} \cdot \frac{3 + 2\sqrt{2} - 1}{3 + 2\sqrt{2}} = \frac{1}{5} \cdot \frac{2(1 + \sqrt{2})}{3 + 2\sqrt{2}} = \frac{2}{5} \cdot \frac{(1 + \sqrt{2})(3 - 2\sqrt{2})}{9 - 8} = \frac{2}{5}(3 - 2\sqrt{2} + 3\sqrt{2} - 4) = \\ &= \frac{2}{5}(\sqrt{2} - 1). \end{aligned}$$

Solution to [Problem 35](#).

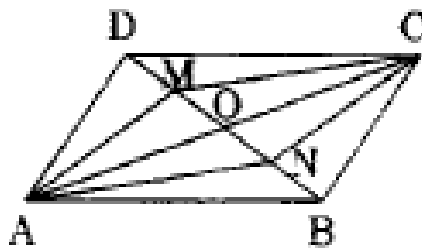

$$\|OM\| = \|NM\| = \|NB\|$$

$$\|DC\|? \Rightarrow \Delta MOC = \Delta NBA \Rightarrow \|MC\| = \|AN\|$$

It is proved in the same way that  $\Delta DAM = \Delta BCN \Rightarrow \|MC\| = \|NC\|$ .

Thus  $ANCM$  is a parallelogram.

$$\begin{aligned}\sigma[AOB] &= \frac{\|OA\| \cdot \|OB\| \sin \alpha}{2} \\ \sigma[AOD] &= \frac{\|OA\| \cdot \|OD\| \sin(\pi - \alpha)}{2} \\ \sigma[ABCD] &= \|OA\| \cdot \|OB\| \sin \alpha + \|OA\| \cdot \|OD\| \sin \alpha = \|OA\| \cdot \sin \alpha (\|OA\| + \|OD\|) = \\ &= \|OA\| \cdot \|DB\| \cdot \sin \alpha \\ \sigma[ANCM] &= \|OA\| \cdot \|MN\| \sin \alpha = \|OA\| \cdot \frac{\|DB\|}{3} \sin \alpha = \frac{\sigma[ABCD]}{3} \Rightarrow \frac{\sigma[AMCN]}{\sigma[ABCD]} = \frac{1}{3}\end{aligned}$$

Solution to [Problem 36](#).

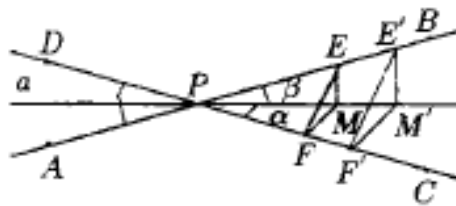

To determine the angle  $\alpha$ :

$$\begin{aligned}\sin \alpha &= \frac{\|EM\|}{\|MP\|}, \quad \sin \beta = \frac{\|MF\|}{\|PM\|} \\ \frac{\sin \alpha}{\sin \beta} &= \frac{\|EM\|}{\|MF\|} = k \Rightarrow \sin \alpha = k \sin(a - \alpha) \Rightarrow \\ &\Rightarrow \sin \alpha = k \sin a \cos \alpha + k \cos a \sin \alpha\end{aligned}$$

We write

$$\begin{aligned}t = \operatorname{tg} \frac{\alpha}{2} \Rightarrow \frac{2t}{1+t^2} &= k \sin a \cdot \frac{1-t^2}{1+t^2} + k \frac{2t}{1+t^2} \cdot \cos a \Rightarrow kt^2 \cos a + 2(1 - k \cos a) \cdot t - \\ -k \sin a &= 0 \Rightarrow t_{1,2} = \frac{k \cos a - 1 \pm \sqrt{(k-1)^2 + 2k(1 - \cos a)}}{k \cos a}\end{aligned}$$

thus we have established the positions of the lines of the locus.

$$\begin{aligned}\sigma[ABM] &= \frac{\|AB\| \cdot \|ME\|}{2} \\ \sigma[CDM] &= \frac{\|CD\| \cdot \|MF\|}{2} \\ \sigma[ABM] = \sigma[CDM] &\Rightarrow \|AB\| \cdot \|ME\| = \|CD\| \cdot \|MF\| \Rightarrow \frac{\|ME\|}{\|MF\|} = \frac{\|CD\|}{\|AB\|}\end{aligned}$$

constant for  $A, B, C, D$  – fixed points.

We must find the geometrical locus of points  $M$  such that the ratio of the distances from this point to two concurrent lines to be constant.

$\frac{\|ME\|}{\|MF\|} = k$ . Let  $M'$  be another point with the same property, namely  $\frac{\|M'E'\|}{\|M'F'\|} = k$ .

$$\left. \begin{array}{l} ME \perp AB \\ M'E' \perp AB \\ MF \perp CD \\ M'F' \perp CD \end{array} \right\} \Rightarrow \left. \begin{array}{l} ME \parallel M'E' \\ MF \parallel M'F' \end{array} \right\} \Rightarrow \left. \begin{array}{l} \widehat{EMF} \equiv \widehat{E'M'F'} \\ \frac{\|ME\|}{\|MF\|} = \frac{\|M'E'\|}{\|M'F'\|} \end{array} \right\} \Rightarrow \Delta MEF \sim \Delta M'E'F' \Rightarrow$$

$$\Rightarrow \widehat{FEM} \equiv \widehat{F'E'M'} \Rightarrow \widehat{PEF} \equiv \widehat{P'E'F'}$$

$$\Rightarrow \left. \begin{array}{l} \frac{\|PE\|}{\|PE'\|} = \frac{\|EF\|}{\|E'F'\|} \\ \frac{\|EF\|}{\|E'F'\|} = \frac{\|EM\|}{\|E'M'\|} \end{array} \right\} \Rightarrow$$

$$\Rightarrow \left. \begin{array}{l} \frac{\|PE\|}{\|PE'\|} = \frac{\|EM\|}{\|E'M'\|} \\ \widehat{PEM} \equiv \widehat{P'E'M'} \end{array} \right\} \Rightarrow \Delta PEM \sim \Delta P'E'M' \Rightarrow \widehat{EPM} \equiv \widehat{E'PM'}$$

$P, M, M'$  collinear  $\Rightarrow$  the locus is a line that passes through  $P$ .

When the points are in  $\sphericalangle CPB$  we obtain one more line that passes through  $P$ . Thus the locus is formed by two concurrent lines through  $P$ , from which we eliminate point  $P$ , because the distances from  $P$  to both lines are 0 and their ratio is indefinite.

Vice versa, if points  $N$  and  $N'$  are on the same line passing through  $P$ , the ratio of their distances to lines  $AB$  and  $CD$  is constant.

$$\left. \begin{array}{l} ME \parallel M'E' \Rightarrow \Delta PME \sim \Delta PM'E' \Rightarrow \frac{\|EM\|}{\|E'M'\|} = \frac{\|PM\|}{\|PM'\|} \\ MF \parallel M'F' \Rightarrow \Delta PMF \sim \Delta PM'F' \Rightarrow \frac{\|FM\|}{\|F'M'\|} = \frac{\|PM\|}{\|PM'\|} \end{array} \right\} \Rightarrow \frac{\|EM\|}{\|E'M'\|} = \frac{\|FM\|}{\|F'M'\|} \Rightarrow$$

$$\Rightarrow \frac{\|EM\|}{\|FM\|} = \frac{\|E'M'\|}{\|F'M'\|} = k$$

Solution to [Problem 37](#).

We show in the same way as in the previous problem that:

$$\frac{\|ME\|}{\|MF\|} = k \Rightarrow \frac{\|ME\|}{\|MF\| + \|ME\|} = \frac{k}{1-k} \Rightarrow \|ME\| = \frac{kd}{1+k},$$

and the locus of the points which are located at a constant distance from a given line is a parallel to the respective line, located between the two parallels.

$$\text{If } \|AB\| > \|CD\| \Rightarrow d(MAE) < d(MCD).$$

Then, if

$$\frac{ME}{MF} = k \Rightarrow \frac{ME}{MF - ME} = \frac{k}{1 - k} \Rightarrow \frac{ME}{d} = \frac{k}{1 - k} \Rightarrow ME = \frac{kd}{1 - k},$$

thus we obtain one more parallel to  $AB$ .

Solution to [Problem 38](#).

*Solution no. 1*

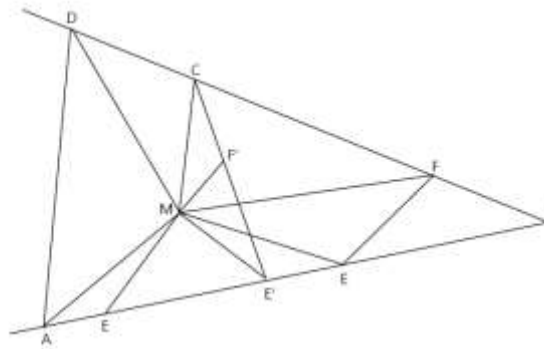

We suppose that  $ABCD$  is not a parallelogram. Let  $\{I\} = AB \cap CD$ . We build  $E \in IA$  such that  $IE = AB$  and  $F \in IC$  such that  $IF = CD$ . If  $M$  a point that verifies  $\sigma[ABM] + \sigma[CDM] = 1$  (1), then, because  $\sigma[ABM] = \sigma[MIE]$  and  $\sigma[CDM] = \sigma[MIF]$ , it results that  $\sigma[MIE] + \sigma[MIF] = k$  (2).

We obtain that  $\sigma[MEIF] = k$ .

On the other hand, the points  $E, F$  are fixed, therefore  $\sigma[IEF] = k' = \text{const.}$  That is,  $\sigma[MEF] = k - k' = \text{const.}$

Because  $EF = \text{const.}$ , we have  $d(M, EF) = \frac{2(k-k')}{EF} = \text{const.}$ , which shows that  $M$  belongs to a line that is parallel to  $EF$ , taken at the distance  $\frac{2(k-k')}{EF}$ .

Therefore, the locus points are those on the line parallel to  $EF$ , located inside the quadrilateral  $ABCD$ . They belong to the segment  $[E'F']$  in Fig. 1.

Reciprocally, if  $M \in [E'F']$ , then  $\sigma[MAB] + \sigma[MCD] = \sigma[MIE] + \sigma[MIF] = \sigma[MEIF] = \sigma[IEF] + \sigma[MEP] = k' + \frac{EF \cdot 2(k-k')}{2 \cdot EF} = k$ .

In conclusion, the locus of points  $M$  inside the quadrilateral  $ABCD$  which occurs for relation (1) where  $k$  is a positive constant smaller than  $S = \sigma[ABCD]$  is a line segment.

If  $ABCD$  is a trapeze having  $AB$  and  $CD$  as bases, then we reconstruct the reasoning as  $AD \cap BC = \{I\}$  and  $\sigma[MAD] + \sigma[MBC] = s - k = \text{const.}$

If  $ABCD$  is a parallelogram, one shows without difficulty that the locus is a segment parallel to  $AB$ .

*Solution no. 2 (Ion Patrascu)*

We prove that the locus of points  $M$  which verify the relationship  $\sigma[MAB] + \sigma[MCD] = k$  (1) from inside the convex quadrilateral  $ABCD$  of area  $s$  ( $k < s$ ) is a line segment.

Let's suppose that  $AB \cap CD = \{I\}$ , see Fig. 2. There is a point  $P$  of the locus which belongs to the line  $CD$ . Therefore, we have  $(P; AB) = \frac{2k}{AB}$ . Also, there is the point  $Q \in AB$  such that  $d(Q; CD) = \frac{2k}{CD}$ .

Now, we prove that the points from inside the quadrilateral  $ABCD$  that are on the segment  $[PQ]$  belong to the locus.

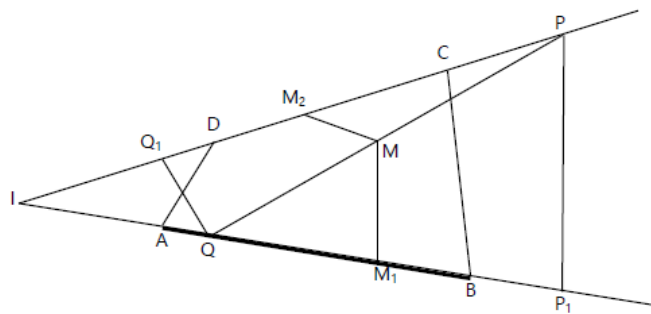

Let  $M \in \text{int}[ABCD] \cap [PQ]$ . We denote  $M_1$  and  $M_2$  the projections of  $M$  on  $AB$  and  $CD$  respectively. Also, let  $P_1$  be the projection of  $P$  on  $AB$  and  $Q_1$  the projection of  $Q$  on  $CD$ . The triangles  $PQ_1Q$  and  $PMM_2$  are alike, which means that

$$\frac{MM_2}{QQ_1} = \frac{MP}{PQ} \quad (2),$$

and the triangles  $MM_1Q$  and  $PP_1Q$  are alike, which means that

$$\frac{MM_1}{PP_1} = \frac{MQ}{PQ} \quad (3).$$

By adding member by member the relations (2) and (3), we obtain

$$\frac{MM_2}{QQ_1} + \frac{MM_1}{PP_1} = \frac{MP + MQ}{PQ} = 1 \quad (4).$$

Substituting in (4),  $QQ_1 = \frac{2k}{CD}$  and  $P_1 = \frac{2k}{AB}$ , we get  $AB \cdot MM_1 + CD \cdot MM_2 = 2k$ , that is  $\sigma[MAB] + \sigma[MCD] = k$ .

We prove now by reductio ad absurdum that there is no point inside the quadrilateral  $ABCD$  that is not situated on the segment  $[PQ]$ , built as shown, to verify the relation (1).

Let a point  $M'$  inside the quadrilateral  $ABCD$  that verifies the relation (1),  $M' \notin [PQ]$ . We build  $M'T \cap AB$ ,  $M'U \parallel CD$ , where  $T$  and  $U$  are situated on  $[PQ]$ , see Fig. 3.

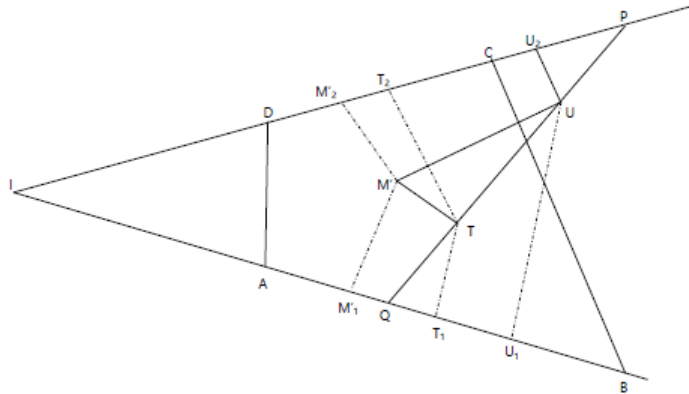

We denote  $M'_1, T_1, U_1$  the projections of  $M', T, U$  on  $AB$  and  $M'_2, T_2, U_2$  the projections of the same points on  $CD$ .

We have the relations:

$$M'M'_1 \cdot AB + M'M'_2 \cdot CD = 2k \quad (5),$$

$$TT_1 \cdot AB + TT_2 \cdot CD = 2k \quad (6).$$

Because  $M'M'_1 = TT_1$  and  $M'M'_2 = UU_2$ , substituting in (5), we get:

$$TT_1 \cdot AB + UU_2 \cdot CD = 2k \quad (7).$$

From (6) and (7), we get that  $TT_2 = UU_2$ , which drives us to  $PQ \parallel CD$ , false!

## Problems in Geometry and Trigonometry

39. Find the locus of the points such that the sum of the distances to two concurrent lines to be constant and equal to  $l$ .

[Solution to Problem 39](#)

40. Show that in any triangle  $ABC$  we have:

a.  $b \cos C + c \cos B = a$ ; b.  $b \cos B + c \cos C = a \cos(B - C)$ .

[Solution to Problem 40](#)

41. Show that among the angles of the triangle  $ABC$  we have:

a.  $b \cos C - c \cos B = \frac{b^2 - a^2}{a}$ ;

b.  $2(bc \cos A + ac \cos B + ab \cos C) = a^2 + b^2 + c^2$ .

[Solution to Problem 41](#)

42. Using the law of cosines prove that  $4m_a^2 = 2(b^2 + c^2) - a^2$ , where  $m_a$  is the length of the median corresponding to the side of length  $a$ .

[Solution to Problem 42](#)

43. Show that the triangle  $ABC$  where  $\frac{a+c}{b} = \cot \frac{B}{2}$  is right-angled.

[Solution to Problem 43](#)

44. Show that, if in the triangle  $ABC$  we have  $\cot A + \cot B = 2 \cot C \Rightarrow a^2 + b^2 = 2c^2$ .

[Solution to Problem 44](#)

45. Determine the unknown elements of the triangle  $ABC$ , given:

a.  $A, B$  and  $p$ ;

b.  $a + b = m, A$  and  $B$ ;

c.  $a, A; b - c = a$ .

[Solution to Problem 45](#)

46. Show that in any triangle  $ABC$  we have  $\tan \frac{A-B}{2} \tan \frac{C}{2} = \frac{a-b}{a+b}$  (*tangents theorem*).

[Solution to Problem 46](#)

47. In triangle  $ABC$  it is given  $\hat{A} = 60^\circ$  and  $\frac{b}{c} = 2 + \sqrt{3}$ . Find  $\tan \frac{B-C}{2}$  and angles  $B$  and  $C$ .

[Solution to Problem 47](#)

48. In a convex quadrilateral  $ABCD$ , there are given  $\|AD\| = 7(\sqrt{6} - \sqrt{2})$ ,  $\|CD\| = 13$ ,  $\|BC\| = 15$ ,  $C = \arccos \frac{33}{65}$ , and  $D = \frac{\pi}{4} + \arccos \frac{5}{13}$ . The other angles of the quadrilateral and  $\|AB\|$  are required.

[Solution to Problem 48](#)

49. Find the area of  $\Delta ABC$  when:

- $a = 17, B = \arcsin \frac{24}{25}, C = \arcsin \frac{12}{13}$ ;
- $b = 2, \hat{A} \in 135^\circ, \hat{C} \in 30^\circ$ ;
- $a = 7, b = 5, c = 6$ ;
- $\hat{A} \in 18^\circ, b = 4, c = 6$ .

[Solution to Problem 49](#)

50. How many distinct triangles from the point of view of symmetry are there such that  $a = 15, c = 13, s = 24$ ?

[Solution to Problem 50](#)

51. Find the area of  $\Delta ABC$  if  $a = \sqrt{6}, \hat{A} \in 60^\circ, b + c = 3 + \sqrt{3}$ .

[Solution to Problem 51](#)

52. Find the area of the quadrilateral from problem 48.

[Solution to Problem 52](#)



53. If  $S_n$  is the area of the regular polygon with  $n$  sides, find:

$S_3, S_4, S_6, S_8, S_{12}, S_{20}$  in relation to  $R$ , the radius of the circle inscribed in the polygon.

[Solution to Problem 53](#)

54. Find the area of the regular polygon  $ABCD \dots M$  inscribed in the circle with

radius  $R$ , knowing that:  $\frac{1}{\|AB\|} = \frac{1}{\|AC\|} + \frac{1}{\|AD\|}$ .

[Solution to Problem 54](#)

55. Prove that in any triangle  $ABC$  we have:

- $r = (p - a) \tan \frac{A}{2}$ ;
- $S = (p - a) \tan \frac{A}{2}$ ;
- $p = 4R \cos \frac{A}{2} \cos \frac{B}{2} \cos \frac{C}{2}$ ;
- $p - a = 4R \cos \frac{A}{2} \cos \frac{B}{2} \cos \frac{C}{2}$ ;
- $m_a^2 = R^2(\sin^2 A + 4 \cos A \sin B \sin C)$ ;
- $h_a = 2R \sin B \sin C$ .

[Solution to Problem 55](#)

56. If  $I$  is the center of the circle inscribed in triangle  $ABC$  show that  $\|AI\| =$

$$4R \sin \frac{B}{2} \sin \frac{C}{2}.$$

[Solution to Problem 56](#)

57. Prove the law of sine using the analytic method.

[Solution to Problem 57](#)

58. Using the law of sine, show that in a triangle the larger side lies opposite to the larger angle.

[Solution to Problem 58](#)

59. Show that in any triangle  $ABC$  we have:

- $\frac{a \cos C - b \cos B}{a \cos B - b \cos A} + \cos C = 0, a \neq b$ ;

$$\text{b. } \frac{\sin(A - B) \sin C}{1 + \cos(A - B) \cos C} = \frac{a^2 - b^2}{a^2 + b^2};$$

$$\text{c. } (a + c) \cos \frac{B}{4} + a \cos \left(A + \frac{3B}{4}\right) = 2c \cos \frac{B}{2} \cos \frac{B}{4}.$$

[Solution to Problem 59](#)

60. In a triangle  $ABC$ ,  $A \in 45^\circ$ ,  $\|AB\| = a$ ,  $\|AC\| = \frac{2\sqrt{2}}{3}a$ . Show that  $\tan B = 2$ .

[Solution to Problem 60](#)

61. Let  $A', B', C'$  be tangent points of the circle inscribed in a triangle  $ABC$  with its sides. Show that  $\frac{\sigma[A'B'C']}{\sigma[ABC]} = \frac{r}{2R}$ .

[Solution to Problem 61](#)

62. Show that in any triangle  $ABC$   $\sin \frac{A}{2} \leq \frac{a}{2\sqrt{bc}}$ .

[Solution to Problem 62](#)

63. Solve the triangle  $ABC$ , knowing its elements  $A, B$  and area  $S$ .

[Solution to Problem 63](#)

64. Solve the triangle  $ABC$ , knowing  $a = 13$ ,  $\arccos \frac{4}{5}$ , and the corresponding median for side  $a$ ,  $m_a = \frac{1}{2}\sqrt{15\sqrt{3}}$ .

[Solution to Problem 64](#)

65. Find the angles of the triangle  $ABC$ , knowing that  $B - C = \frac{2\pi}{3}$  and  $R = 8r$ , where  $R$  and  $r$  are the radii of the circles circumscribed and inscribed in the triangle.

[Solution to Problem 65](#)

## Solutions

Solution to [Problem 39](#).

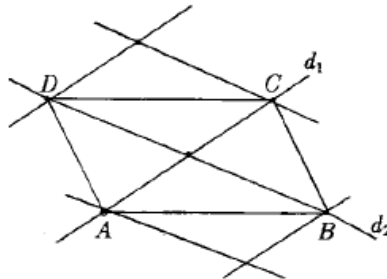

Let  $d_1$  and  $d_2$  be the two concurrent lines. We draw 2 parallel lines to  $d_1$  located on its both sides at distance  $l$ . These intersect on  $d_2$  at  $D$  and  $B$ , which will be points of the locus to be found, because the sum of the distances  $d(B, d_1) + d(B, d_2) = l + 0$  verifies the condition from the statement.

We draw two parallel lines with  $d_2$  located at distance  $l$  from it, which cut  $d_1$  in  $A$  and  $C$ , which are as well points of the locus to be found. The equidistant parallel lines determine on  $d_2$  congruent segments  $\Rightarrow \begin{matrix} |DO| \equiv |OB| \\ |AO| \equiv |OC| \end{matrix}$ , in the same way  $ABCD$  is a parallelogram.

$$\Delta BOC, \left. \begin{matrix} \|CC'\| = d(C, d_2) \\ \|BB'\| = d(B, d_1) \end{matrix} \right\} \Rightarrow \|CC'\| = \|BB'\|$$

$\Rightarrow \Delta BOC$  is isosceles.

$\Rightarrow \|OC\| = \|OB\| \Rightarrow ABCD$  is a rectangle. Any point  $M$  we take on the sides of this rectangle, we have  $\|R_1, d_1\| + \|M, d_2\| = l$ , using the propriety according to which the sum of the distances from a point on the base of an isosceles triangle at the sides is constant and equal to the height that starts from one vertex of the base, namely  $l$ . Thus the desired locus is rectangle  $ABCD$ .

Solution to [Problem 40](#).

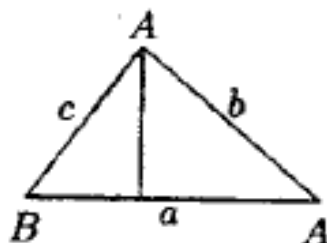

$$\triangle ABC : \cos B = \frac{\|BD\|}{c} \Rightarrow \|BD\| = c \cos B$$

$$\triangle ADC : \cos C = \frac{\|DC\|}{b} \Rightarrow \|DC\| = b \cos C$$

$$a = \|BD\| + \|DC\| = c \cos B + b \cos C$$

$$\frac{a}{\sin A} = \frac{b}{\sin B} = \frac{c}{\sin C} = m \Rightarrow \begin{cases} b = m \sin B \\ c = m \sin C \end{cases}$$

$$\begin{aligned} b \cos B + c \cos C &= m \sin B \cos B + m \sin C \cos C = \frac{m}{2}(2 \sin B \cos B + 2 \sin C \cos C) = \\ &= \frac{m}{2}(\sin 2B + \sin 2C) = \frac{m}{2} \cdot 2 \sin(B+C) \cos(B-C) = \frac{a}{\sin A} \sin(\pi - A) \cos(B-C) = \\ &= a \cos(B-C). \end{aligned}$$

Solution to [Problem 41](#).

$$\text{a) } \cos C = \frac{a^2 + b^2 - c^2}{2ab} \text{ si } \cos B = \frac{a^2 + b^2 - c^2}{2ac}$$

$$\begin{aligned} b \cos C - c \cos B &= b \cdot \frac{a^2 + b^2 - c^2}{2ab} - c \cdot \frac{a^2 + c^2 - b^2}{2ac} = \frac{a^2 + b^2 - c^2 - a^2 - c^2 + b^2}{2a} = \\ &= \frac{2b^2 - 2c^2}{2a} = \frac{b^2 - c^2}{a} \end{aligned}$$

$$\begin{aligned} \text{b) } \quad 2bc \cos A + 2ac \cos B + 2ab \cos C &= 2bc \frac{b^2 + c^2 - a^2}{2bc} + \\ + 2ac \frac{a^2 + c^2 - b^2}{2ac} + 2ab \frac{a^2 + b^2 - c^2}{2ab} &= b^2 + c^2 - a^2 + a^2 + c^2 - b^2 + a^2 + b^2 - c^2 = a^2 + b^2 + c^2 \end{aligned}$$

Solution to [Problem 42](#).

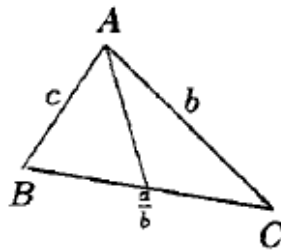

$$m_a^2 = c^2 + \frac{a^2}{4} - 2 \frac{a}{2} c \cos B ;$$

$$\begin{aligned} 4m_a^2 &= 4c^2 + a^2 - 4ac \cos B = 4c^2 + a^2 - 4ac \frac{a^2 + c^2 - b^2}{2ac} = 4c^2 + a^2 - 2a - 2c^2 + 2b^2 \\ &= 2c^2 + 2b^2 - a^2 = 2(b^2 + c^2) - a^2. \end{aligned}$$

Solution to [Problem 43](#).

Using the sine theorem,  $a = m \sin A$ .

$$\frac{a}{\sin A} = \frac{b}{\sin B} = \frac{c}{\sin C} = m \Rightarrow b = m \sin B$$

$$c = m \sin C$$

$$\frac{a+c}{b} = \frac{m \sin A + m \sin C}{m \sin B} = \frac{\sin A + \sin C}{\sin B} = \frac{2 \sin \frac{A+C}{2} \cos \frac{A-C}{2}}{2 \sin \frac{B}{2} \cos \frac{B}{2}} =$$

$$\left. \begin{aligned} \frac{\sin(\frac{\pi}{2} - \frac{B}{2}) \cos \frac{A-C}{2}}{\sin \frac{B}{2} \cos \frac{B}{2}} &= \frac{\cos \frac{B}{2} \cos \frac{A-C}{2}}{\sin \frac{B}{2} \cos \frac{B}{2}} = \frac{\cos \frac{A-C}{2}}{\sin \frac{B}{2}} \\ \text{ctg } \frac{B}{2} &= \frac{\cos \frac{B}{2}}{\sin \frac{B}{2}} \end{aligned} \right\} \Rightarrow \cos \frac{A-C}{2} = \cos \frac{B}{2} \Rightarrow$$

$$\Rightarrow \frac{A-C}{2} = \frac{B}{2}$$

$$\frac{A-C}{2} = -\frac{B}{2} \Rightarrow A-B=C \text{ or } A-C=B \Rightarrow \begin{array}{lll} A=B+C & 2A=180^\circ & A=90^\circ \\ \text{or } \Rightarrow & \text{or } \Rightarrow & \text{or} \\ A+B=C & 2C=180^\circ & C=90^\circ \end{array}$$

Solution to [Problem 44](#).

$$\text{ctg } A + \text{ctg } B = 2 \text{ctg } C \Rightarrow \frac{\cos A}{\sin A} + \frac{\cos B}{\sin B} = 2 \frac{\cos C}{\sin C}$$

$$\cos A = \frac{b^2 + c^2 - a^2}{2bc}$$

$$\cos B = \frac{a^2 + c^2 - b^2}{2ac}$$

$$\cos C = \frac{a^2 + b^2 - c^2}{2ab}$$

$$\frac{a}{\sin A} = \frac{b}{\sin B} = \frac{c}{\sin C} = m \Rightarrow \sin A = \frac{a}{m}, \sin B = \frac{b}{m}, \sin C = \frac{c}{m};$$

By substitution:

$$2c^2 = 2(a^2 + b^2 - c^2) \Rightarrow 2c^2 = a^2 + b^2$$

Solution to [Problem 45](#).

a. Using the law of sine,

$$\begin{aligned} &\Rightarrow \frac{a}{\sin A} = \frac{b}{\sin B} = \frac{c}{\sin C} = \frac{a+b+c}{\sin A + \sin B + \sin C} = \\ &= \frac{2p}{\sin A + \sin B + \sin C} \\ &a = \frac{2p \sin A}{\sin A + \sin B + \sin C}; b = \frac{2p \sin B}{\sin A + \sin B + \sin C}; c = \frac{2p \sin C}{\sin A + \sin B + \sin C} \\ &\text{iar } C = \pi - (A + B) \end{aligned}$$

b.

$$\begin{aligned} \frac{a}{\sin A} = \frac{b}{\sin B} = \frac{a+b}{\sin A + \sin B} = \frac{m}{\sin A + \sin B} &\Rightarrow a = \frac{m \sin A}{\sin A + \sin B} \\ b = \frac{m \sin B}{\sin A + \sin B} &\Rightarrow \\ \Rightarrow c = \frac{a \sin C}{\sin A} = \frac{a \sin(A+B)}{\sin A} \text{ dar } \frac{a}{\sin A} = \frac{c}{\sin C} \end{aligned}$$

c.

$$\begin{aligned} \frac{a}{\sin A} = \frac{b}{\sin B} = \frac{c}{\sin C}; \frac{b}{\sin B} = \frac{c}{\sin B} = \frac{b-c}{\sin B - \sin C} = \frac{d}{\sin B - \sin C} = \frac{a}{\sin A} &\Rightarrow \\ \Rightarrow \sin B - \sin C = \frac{d \sin A}{a} &\Rightarrow \\ \Rightarrow 2 \sin \frac{B-C}{2} \cos \frac{B+C}{2} = \frac{d \sin A}{a} & \\ B+C = \pi - A \Rightarrow \frac{B+C}{2} = \frac{\pi}{2} - \frac{A}{2} \Rightarrow \cos \frac{B+C}{2} = \sin \frac{A}{2} \end{aligned}$$

Therefore,

$$2 \sin \frac{B-C}{2} \sin \frac{A}{2} = \frac{d}{a} 2 \sin \frac{A}{2} \cos \frac{A}{2} \Rightarrow \sin \frac{B-C}{2} = \frac{d}{a} \cos \frac{A}{2}$$

We solve the system, and find  $B$  and  $C$ . Then we find  $b = \frac{a \sin B}{\sin A}$  and  $c = b - d$ .

Solution to [Problem 46](#).

$$\frac{a}{\sin A} = \frac{b}{\sin B} = \frac{c}{\sin C} = m \Rightarrow \begin{cases} a = m \sin A \\ b = m \sin B \end{cases}$$

$$\begin{aligned} \frac{a-b}{a+b} = \frac{m \sin A - m \sin B}{m \sin A + m \sin B} = \frac{\sin A - \sin B}{\sin A + \sin B} &= \frac{2 \sin \frac{A-B}{2} \cos \frac{A+B}{2}}{2 \sin \frac{A+B}{2} \cos \frac{A-B}{2}} = \tan \frac{A-B}{2} \frac{\sin \frac{C}{2}}{\cos \frac{C}{2}} \\ &= \tan \frac{A-B}{2} \tan \frac{C}{2}. \end{aligned}$$

Solution to [Problem 47](#).

Using tangents' theorem,

$$\frac{b-c}{b+c} = \operatorname{tg} \frac{B-C}{2} \operatorname{tg} \frac{A}{2}$$

$$\hat{A} \in 60^\circ \Rightarrow m\left(\frac{A}{2}\right) = 30^\circ \Rightarrow \operatorname{tg} \frac{A}{2} = \frac{\sqrt{3}}{3} = \frac{1}{\sqrt{3}}$$

$$\frac{b}{c} = \frac{2+\sqrt{3}}{1} \Rightarrow \frac{b-c}{b+c} = \frac{2+\sqrt{3}-1}{2+\sqrt{3}+1} = \frac{1+\sqrt{3}}{3+\sqrt{3}}$$

$$\operatorname{tg} \frac{B-C}{2} = \frac{1+\sqrt{3}}{3+\sqrt{3}} \cdot \frac{1}{\frac{1}{\sqrt{3}}} = 1 \Rightarrow \mu\left(\frac{B-C}{2}\right) = 45^\circ \Rightarrow \begin{cases} B-C = 90^\circ \\ B+C = 120^\circ \end{cases}$$

$$2B = 210^\circ \Rightarrow \mu(B) = 105^\circ \Rightarrow \mu(C) = 120^\circ - 105^\circ = 15^\circ$$

So

$$\mu(C) = \frac{\pi}{12} \text{ și } \mu(B) = \frac{7\pi}{12}.$$

Solution to [Problem 48](#).

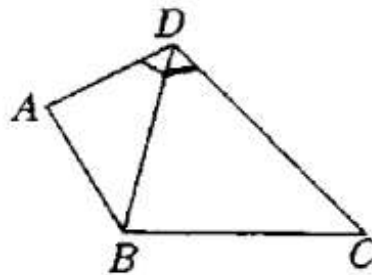

$$\|BD\|^2 = 13^2 - 15^2 - 2 \cdot 13 \cdot 15 \cos C = 13^2 + 15^2 - 2 \cdot 13 \cdot 15 \frac{33}{65} =$$

$$= 13^2 + 15^2 - 2 \cdot 13 \cdot 15 \cdot \frac{3 \cdot 11}{13 \cdot 5} = 13^2 + 15^2 - 18 \cdot 11 = 196 \Rightarrow$$

$$\Rightarrow \|BD\| = 14$$

In  $\triangle BDC$  we have

$$\frac{14}{\sin C} = \frac{15}{\sin \widehat{BDC}} \Rightarrow \sin \widehat{BDC} = \frac{15 \cdot \sin C}{14}$$

$$\sin C = \sqrt{1 - \frac{33^2}{65^2}} = \sqrt{\frac{(65-33)(65+33)}{65^2}} = \sqrt{\frac{2^6 \cdot 7^2}{65^2}} = \frac{56}{65}$$

$$\sin \widehat{BDC} = \frac{15 \cdot 56}{14 \cdot 65} = \frac{15 \cdot 56}{14 \cdot 65} = \frac{3 \cdot 5 \cdot 14 \cdot 4}{14 \cdot 5 \cdot 13} = \frac{12}{13}$$

$$\cos 2\widehat{BDC} = \sqrt{1 - \frac{144}{169}} = \sqrt{\frac{169-144}{169}} = \frac{5}{13}$$

$$\sin \widehat{BDC} = \arccos \frac{5}{13}$$

$$\sin \widehat{ADB} = \frac{\pi}{4} + \arccos \frac{5}{13} - \arccos \frac{5}{13} = \frac{\pi}{4}.$$

In  $\triangle ADB$ ,

$$\begin{aligned} \Rightarrow \|AB\|^2 &= 49(\sqrt{6} - \sqrt{2})^2 + 14^2 - 2 \cdot 14 \cdot 7(\sqrt{6} - \sqrt{2}) \frac{\sqrt{2}}{2} = 49(6 + 2 - 2\sqrt{2}) + \\ &+ 196 - 93(\sqrt{2} - 2) = 98(4 - \sqrt{12}) - 98(\sqrt{12} - 2) + 196 = 98(4 - \sqrt{12} - \sqrt{12} + 2) + 196 = \\ &= 196(3 - \sqrt{12}) + 196 = 196(4 - 2\sqrt{3}) = 196(\sqrt{3} - 1)^2, \\ \|AB\| &= 14(\sqrt{3} - 1) \end{aligned}$$

In  $\triangle ADB$  we apply sine's theorem:

$$\frac{\|AD\|}{\sin \widehat{ABD}} = \frac{\|AB\|}{\sin \frac{\pi}{4}} \Rightarrow \frac{7(\sqrt{6} - \sqrt{2})}{\sin \widehat{ABD}} = \frac{14(\sqrt{3} - 1)}{\frac{\sqrt{2}}{2}} = \frac{28(\sqrt{3} - 1)}{\sqrt{2}}$$

$$\sin \widehat{ABD} = \frac{7(\sqrt{6} - \sqrt{2})}{28(\sqrt{3} - 1)} = \frac{14(\sqrt{3} - 1)}{28(\sqrt{3} - 1)} = \frac{1}{2} = \mu(\widehat{ABD}) = \frac{\pi}{6}$$

$$\mu(A) = \pi - \frac{\pi}{6} - \frac{\pi}{4} = \frac{12\pi - 2\pi - 3\pi}{12} = \frac{7\pi}{12}$$

$$\mu(D) = 2\pi - \frac{7\pi}{12} - \frac{\pi}{4} - \arccos \frac{5}{13} - \arccos \frac{33}{65} = \frac{14\pi}{12} - \underbrace{\left(\arccos \frac{5}{13} + \arccos \frac{33}{65}\right)}_{\alpha + \beta}$$

$$\cos \alpha = \frac{5}{13} \Rightarrow \sin \alpha = \frac{12}{13}$$

$$\cos \beta = \frac{33}{65} \Rightarrow \sin \beta = \frac{56}{65}$$

$$\cos(\alpha + \beta) = \cos \alpha \cos \beta - \sin \alpha \sin \beta = \frac{5}{13} \cdot \frac{33}{65} - \frac{12 \cdot 56}{13 \cdot 65} = -\frac{507}{13 \cdot 65} = -\frac{3 \cdot 13^2}{13 \cdot 13 \cdot 5} = -\frac{3}{5}$$

$$\alpha + \beta = \pi - \arccos \frac{3}{5}$$

$$\mu(D) = \frac{14\pi}{12} - \pi + \arccos \frac{3}{5} = \frac{2\pi}{12} + \arccos \frac{3}{5} = \frac{\pi}{6} + \arccos \frac{3}{5}$$

Or we find  $\mu(\widehat{DBC})$  and we add it to  $\frac{\pi}{6}$ .

Solution to [Problem 49](#).

$$a) B = \arcsin \frac{24}{25} \Rightarrow \sin B = \frac{24}{25} \Rightarrow \cos B = \frac{7}{25}$$

$$C = \arcsin \frac{12}{13} \Rightarrow \sin C = \frac{12}{13} \Rightarrow \cos C = \frac{5}{13}$$

$$\begin{aligned} \sin A &= \sin[\pi - (B + C)] = \sin(B + C) = \sin B \cos C + \sin C \cos B = \frac{24}{25} \cdot \frac{5}{13} + \frac{12}{13} \cdot \frac{7}{25} = \\ &= \frac{120 + 84}{325} = \frac{204}{325} \end{aligned}$$



$$S = \frac{a^2 \sin B \sin C}{2 \sin A} = \frac{289 \cdot \frac{24}{25} \cdot \frac{12}{13}}{2 \cdot \frac{204}{325}}$$

b)  $b = 2, \hat{A} \in 135^\circ, \hat{C} \in 30^\circ \Rightarrow \hat{B} \in 15^\circ$

$$\sin A = \sin 45 = \frac{\sqrt{2}}{2}$$

$$\sin C = \frac{1}{2}$$

$$\begin{aligned} \sin B &= \sin \frac{30^\circ}{2} = \sqrt{\frac{1 - \cos 30^\circ}{2}} = \sqrt{\frac{1 - \frac{\sqrt{3}}{2}}{2}} = \sqrt{\frac{2 - \sqrt{3}}{2}} = \frac{1}{2} \left( \sqrt{\frac{2+1}{2}} - \sqrt{\frac{2-1}{2}} \right) = \\ &= \frac{1}{2} \left( \frac{\sqrt{3}}{2} - \sqrt{\frac{1}{2}} \right) = \frac{\sqrt{3} - 1}{2\sqrt{2}} \end{aligned}$$

$$S = \frac{b^2 \sin A \sin C}{2 \sin B} = \frac{4 \cdot \frac{\sqrt{2}}{2} \cdot \frac{1}{2}}{2 \cdot \frac{\sqrt{3} - 1}{2\sqrt{2}}} = \frac{\sqrt{2}}{\sqrt{3} - 1} = \frac{\sqrt{2}(\sqrt{3} + 1)}{2}$$

d)  $\hat{A} \in 18^\circ, b = 4, c = 6$

$$\mu(A) = \frac{\pi}{10} 0$$

$$2\hat{A} = 36^\circ, 3\hat{A} \in 54^\circ$$

$$\sin \alpha = \cos(90^\circ - \alpha)$$

$$\sin 30^\circ = \cos 54^\circ \Rightarrow \sin 2A = \cos 3A \Rightarrow 2 \sin A \cos A = \cos(4 \cos^2 A - 3) \Rightarrow$$

$$\Rightarrow 4 \sin^2 A + 2 \sin A - 1 = 0$$

$$\sin A = \frac{-2 \pm \sqrt{20}}{8} = \frac{-2 \pm 2\sqrt{5}}{8} = \frac{-1 \pm \sqrt{5}}{4}$$

$$\sin A = \frac{-1 + \sqrt{5}}{4}, \text{ because } m(A) < 180^\circ \text{ and } \sin A > 0.$$

Solution to [Problem 50](#).

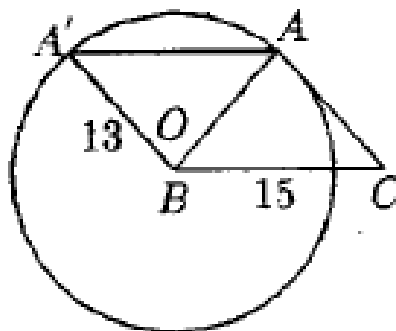

$$\frac{ac \sin B}{2} = 24 \Rightarrow \sin B = \frac{48}{15 \cdot 13} = \frac{16}{65}$$

$$\cos B = \sqrt{1 - \frac{16^2}{65^2}} = \sqrt{\frac{(65-16)(65+16)}{65^2}} =$$

$$= \sqrt{\frac{49 \cdot 81}{65^2}} = \frac{7 \cdot 9}{65} = \frac{63}{65}$$

$$b^2 = 13^2 + 15^2 - 2 \cdot 13 \cdot 15 \cdot \frac{7 \cdot 9}{13 \cdot 5} = 13^2 + 15^2 - 376 = 394 - 378 = 16,$$

$$b = 4$$

$$b^2 = 13^2 + 15^2 + 2 \cdot 13 \cdot 15 \cdot \frac{7 \cdot 9}{13 \cdot 5} = 394 + 378 = 772 = 4 \cdot 193$$

$$b = 2\sqrt{193}.$$

Solution to [Problem 51](#).

$$a^2 = b^2 + c^2 - 2bc \cos A \Rightarrow 6 = b^2 + c^2 - 2bc \frac{1}{2}$$

$$\left. \begin{aligned} 6 &= (b+c)^2 - 2bc - bc = (b+c)^2 - 3bc \\ b+c &= 3 + \sqrt{3} \end{aligned} \right\} \Rightarrow (3 + \sqrt{3})^2 - 3bc = 6$$

$$9 + 6\sqrt{3} + 3 - 3bc = 6 \Rightarrow 2(1 + \sqrt{3}) = bc$$

$$\left. \begin{aligned} b+c &= 3 + \sqrt{3} \\ bc &= 2 + 2\sqrt{3} \end{aligned} \right\} \Rightarrow x^2 - 5x + p = 0 \Rightarrow x^2 - (3 + \sqrt{3})x + 2 + 2\sqrt{3} = 0 \Rightarrow$$

$$\Rightarrow x_{1,2} = \frac{3 + \sqrt{3} \pm \sqrt{4 - 2\sqrt{3}}}{2} = \frac{3 + \sqrt{3} \pm \sqrt{\sqrt{(3-1)^2}}}{2} = \frac{3 + \sqrt{3} \pm (\sqrt{3} - 1)}{2} \Rightarrow$$

$$\Rightarrow \begin{aligned} x_1 &= 1 + \sqrt{3} \\ x_2 &= 2 \end{aligned}$$

$$b = 1 + \sqrt{3} \text{ și } c = 2 \text{ sau } b = 2 \text{ și } c = 1 + \sqrt{3}$$

$$2p = \sqrt{6} + 1 + \sqrt{3} + 2 = 3 + \sqrt{3} + 2 = 3 + \sqrt{3} + \sqrt{6} \Rightarrow p = \frac{3 + \sqrt{3} + \sqrt{6}}{2}$$

$$S = \sqrt{p(p-a)(p-b)(p-c)}.$$

Solution to [Problem 52](#).

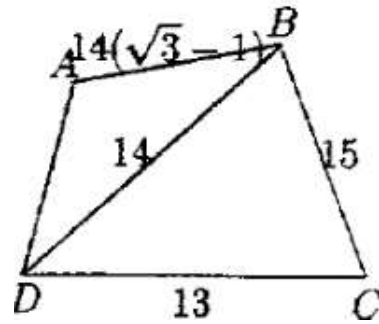

$$\|AD\| = 7(\sqrt{6} - \sqrt{2})$$

$$\|CD\| = 13, \quad \|BC\| = 15$$

At problem 9 we've found that

$$\|BD\| = 14, \quad \|AB\| = 14(\sqrt{3} - 1)$$

With Heron's formula, we find the area of each triangle and we add them up.

$$\sigma[ABCD] = \sigma[ABD] + \sigma[BDC]$$

Solution to [Problem 53](#).

The formula for the area of a regular polygon:

$$S_n = \frac{n}{2} R^2 \sin \frac{2\pi}{n}$$

$$n = 3 \Rightarrow S_3 = \frac{3}{2} R^2 \sin \frac{2\pi}{3} = \frac{3\sqrt{3}R^2}{4}$$

$$n = 4 \Rightarrow S_4 = \frac{4}{2} R^2 \sin \frac{2\pi}{4} = 2R^2$$

$$n = 6 \Rightarrow S_6 = \frac{6}{2} R^2 \sin \frac{2\pi}{6} = \frac{3\sqrt{3}R^2}{2}$$

$$n = 8 \Rightarrow S_8 = \frac{8}{2} R^2 \sin \frac{2\pi}{8} = 2\sqrt{2}R^2$$

$$n = 12 \Rightarrow S_{12} = \frac{12}{2} R^2 \sin \frac{2\pi}{12} = 3R^2$$

$$n = 20 \Rightarrow S_{20} = \frac{20}{2} R^2 \sin \frac{2\pi}{20} = 10R^2 \frac{\sqrt{5}-1}{4} = \frac{5}{2}(\sqrt{5}-1)R^2$$

Solution to [Problem 54](#).

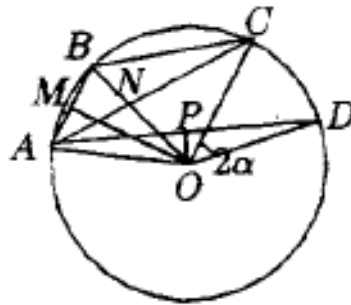

$$m(\widehat{AB}) = 2d \Rightarrow m(\widehat{AOB}) = 2d$$

In  $\triangle BOM$ :

$$\sin \alpha = \frac{\|BM\|}{\|BO\|} \Rightarrow \begin{cases} \|BM\| = R \sin \alpha \\ \|AB\| = 2R \sin \alpha \end{cases} \quad (1)$$

In  $\triangle NOC$ :

$$\sin 2\alpha = \frac{\|NC\|}{\|OC\|} \Rightarrow \|NC\| = R \sin 2\alpha \Rightarrow \|AC\| = 2R\alpha \quad (2)$$

In  $\triangle POD$ :

$$\begin{aligned} \sin 3\alpha &= \frac{\|DP\|}{\|OD\|} \Rightarrow \|DP\| = R \sin 3\alpha \\ \|AD\| &= 2R \sin 3\alpha \end{aligned} \quad (3)$$

Substituting (1), (2), (3) in the given relation:

$$\begin{aligned} \frac{1}{2R \sin \alpha} &= \frac{1}{2R \sin 2\alpha} = \frac{1}{2R \sin 3\alpha} \Rightarrow \frac{1}{\sin \alpha} = \frac{1}{\sin 2\alpha} = \frac{1}{\sin 3\alpha} \\ \frac{1}{\sin 2\alpha} &= \frac{1}{\sin \alpha} = \frac{1}{\sin 3\alpha} \Rightarrow \frac{1}{\sin 2\alpha} = \frac{\sin 3\alpha - \sin \alpha}{\sin \alpha \cdot \sin 3\alpha} = \frac{2 \sin \alpha \cdot \cos 2\alpha}{\sin \alpha \cdot \sin 3\alpha} \Rightarrow 2 \sin 2\alpha \cos 2\alpha = \\ &= \sin 3\alpha \Rightarrow \sin 4\alpha = \sin 3\alpha \Rightarrow \sin 4\alpha - \sin 3\alpha = 0 \Rightarrow 2 \sin \frac{\alpha}{2} \cos \frac{7\alpha}{2} = 0 \iff \sin \frac{\alpha}{2} = 0 \end{aligned}$$

or

$$\begin{aligned} \cos \frac{7\alpha}{2} &= 0. \\ \sin \frac{\alpha}{2} &\Rightarrow \frac{\alpha}{2} = 0 \end{aligned}$$

which is impossible.

$$\begin{aligned} \cos \frac{7\alpha}{2} = 0 &\Rightarrow \frac{7\alpha}{2} = \frac{\pi}{2} \Rightarrow \alpha = \frac{\pi}{7} \Rightarrow m(\widehat{AB}) = \frac{2\pi}{7} \\ n &= \frac{m(\text{complete circle})}{m(\widehat{AB})} = \frac{2\pi}{\frac{2\pi}{7}} = 7. \end{aligned}$$

Thus the polygon has 7 sides.

$$S_7 = \frac{7}{2} R^2 \sin \frac{2\pi}{7}$$

Solution to [Problem 55](#).

$$\text{a) } \sin \frac{A}{2} = \sqrt{\frac{(p-b)(p-c)}{bc}}, \cos \frac{A}{2} = \sqrt{\frac{p(p-a)}{bc}} \Rightarrow \operatorname{tg} \frac{A}{2} = \sqrt{\frac{(p-b)(p-c)}{p(p-a)}}$$

$$\begin{aligned} (p-a) \operatorname{tg} \frac{A}{2} &= (p-a) \sqrt{\frac{(p-b)(p-c)}{p(p-a)}} = \sqrt{\frac{(p-a)^2(p-b)(p-c)}{p(p-a)}} = \\ &= \sqrt{\frac{p(p-a)(p-b)(p-c)}{p^2}} = \frac{9}{p} = r \end{aligned}$$

$$\text{b) } \frac{S}{p} = (p-a) \operatorname{tg} \frac{A}{2} \Rightarrow S = p(p-a) \operatorname{tg} \frac{A}{2}$$

$$\text{c) } \cos \frac{A}{2} = \sqrt{\frac{p(p-a)}{bc}}, \cos \frac{B}{2} = \sqrt{\frac{p(p-b)}{ac}}, \cos \frac{C}{2} = \sqrt{\frac{p(p-c)}{ab}}, R = \frac{abc}{4S} \Rightarrow 4R = \frac{abc}{S}$$

$$\begin{aligned} 4R \cos \frac{A}{2} \cos \frac{B}{2} \cos \frac{C}{2} &= \frac{abc}{S} \cdot \sqrt{\frac{p^3(p-a)(p-b)(p-c)}{a^2b^2c^2}} = \frac{abc}{S} \frac{\sqrt{p^3(p-a)(p-b)(p-c)}}{abc} = \frac{abc}{S} \\ &\frac{pS}{abc} = p \end{aligned}$$

$$\text{d) } 4R \cos \frac{A}{2} \cos \frac{B}{2} \cos \frac{C}{2} = \frac{abc}{S} \cdot \sqrt{\frac{p(p-a)^3(p-b)(p-c)}{bcacab}} = \frac{abc}{S} \cdot \frac{p-a}{abc}$$

$$S = p - a$$

$$\sin A = \frac{a}{2R}, \sin B = \frac{b}{2R}, \sin C = \frac{c}{2R}$$

$$\cos A = \frac{b^2 + c^2 - a^2}{2bc}$$

$$\begin{aligned} R^2(\sin^2 A + 4 \cos A \sin B \sin C) &= R^2 \left( \frac{a^2}{4R^2} + 4 \frac{b^2 + c^2 - a^2}{2bc} \cdot \frac{b}{2R} \cdot \frac{c}{2R} \right) = \\ &= R^2 \frac{a^2 + 2b^2 + 2c^2 - 2a^2}{4R^2} = \frac{2(b^2 + c^2) - a^2}{4} = \mu_a^2 \end{aligned}$$

$$\text{f) } S = \frac{ah_a}{2} \Rightarrow h_a = \frac{2S}{a}, R = \frac{abc}{4S}, \frac{b}{2R} = \sin B, \frac{c}{2a} = \sin C$$

$$2R \sin B \sin C = 2R \cdot \frac{b}{2R} \cdot \frac{c}{2R} = \frac{bc}{2R} = \frac{bc}{2 \cdot \frac{abc}{4S}} = \frac{2bcS}{abc} = \frac{2S}{a} = h_a$$

Solution to [Problem 56](#).

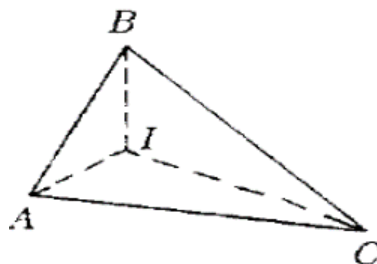

We apply the law of sine in  $\Delta ABI$ :

$$\frac{\|AI\|}{\sin \frac{B}{2}} = \frac{\|BI\|}{\sin \frac{A}{2}} = \frac{\|AB\|}{\sin \widehat{BIA}}$$

$$m(\widehat{BIA}) = 180^\circ - \frac{A+B}{2} = 180^\circ - 90^\circ + \frac{c}{2} = 90^\circ + \frac{c}{2}$$

$$\sin \widehat{BIA} = \sin(90^\circ + \frac{c}{2}) = \sin(180^\circ - 90^\circ - \frac{c}{2}) = \sin(90^\circ - \frac{c}{2}) = \cos \frac{c}{2}$$

The law of sine applied in  $\Delta ABC$ :

$$\frac{\|AB\|}{\sin C} = 2R \Rightarrow \|AB\| = 2R \sin C = 4R \sin \frac{C}{2} \cos \frac{C}{2} \sin \frac{B}{2}$$

$$\frac{1}{\cos \frac{C}{2}} = 4R \sin \frac{B}{2} \sin \frac{C}{2}$$

Solution to [Problem 57](#).

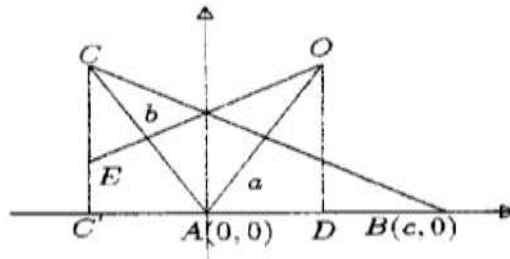

$$\text{In } \Delta ACC': \sin(180^\circ - A) = \frac{\|CC'\|}{b} \Rightarrow \|CC'\| = b \sin A; \cos(180^\circ - A) = b \cos A.$$

So the coordinates of  $C$  are  $(-b \cos A, b \sin A)$ .

The center of the inscribed circle is at the intersection of the perpendicular lines drawn through the midpoints of sides  $AB$  and  $AC$ .

$$m_{EO} = -\frac{1}{m_{AC}} = \frac{1}{\text{tg } A} = \text{ctg } A$$

$$E\left(\frac{O - b \cos A}{2}, \frac{O + b \sin A}{2}\right) = E\left(-\frac{b \cos A}{2}, \frac{b \sin A}{2}\right)$$

The equation of the line  $EO$ :

$$y - y_0 = m(\lambda - x_0) \Rightarrow y - \frac{b \sin A}{2} = \text{ctg } A\left(x + \frac{b \cos A}{2}\right)$$

$$R = \|OA\| = \sqrt{\left(\frac{c}{2}\right)^2 + \left(\frac{b}{2 \sin A} + \frac{c \cos A}{2 \sin A}\right)^2} =$$

$$= \sqrt{\frac{c^2}{4} + \frac{b^2}{4} \cdot \frac{1}{\sin^2 A} + 2 \cdot \frac{bc \cos A}{4 \sin^2 A} + \frac{c^2}{4} \cdot \frac{\cos^2 A}{\sin^2 A}} =$$

$$\begin{aligned}
 &= \sqrt{\frac{c^2}{4} \left(1 + \frac{\cos^2 A}{\sin^2 A}\right) + \frac{1}{4 \sin^2 A} (b^2 + 2bc \cos A)} = \\
 &= \sqrt{\frac{1}{4 \sin^2 A} (c^2 + b^2 + 2bc \cos A)} = \sqrt{\frac{a^2}{4 \sin^2 A}} = \\
 &= \frac{a}{2 \sin A} \Rightarrow R = \frac{a}{2 \sin A}
 \end{aligned}$$

If we redo the calculus for the same draw, we have the following result:  
 $(b \cos A, b \sin A)$ .

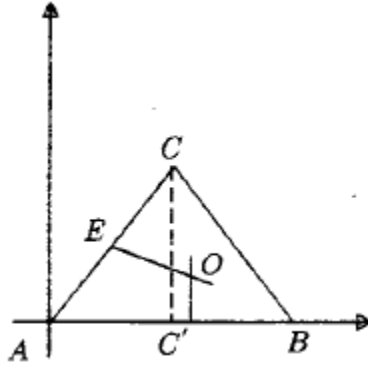

$$\begin{aligned}
 m_{AC} = \operatorname{tg} A &\Rightarrow m_{OE} = -\frac{1}{\operatorname{tg} A} \\
 (OE) : 2 \sin A &= -2x \cos A + B \\
 O\left(\frac{c}{2}, \frac{-c \cos A + b}{2 \sin A}\right) &\text{ și } \|OA\| = R = \\
 = \sqrt{\frac{c^2}{4} + \frac{b^2 + c^2 \cos A - 2bc \cos A}{4 \sin^2 A}} &= \\
 = \sqrt{\frac{1}{4 \sin^2 A} \cdot (c^2 \sin^2 A + c^2 \cos^2 A + b^2 - 2bc \cos A)} &= \frac{a}{2 \sin A},
 \end{aligned}$$

using the law of cosine.

Solution to [Problem 58](#).

$$\frac{a}{\sin A} = \frac{b}{\sin B} = \frac{c}{\sin C} = 2R.$$

We suppose that  $a > b$ . Let's prove that  $A > B$ .

$$\begin{aligned}
 \left. \begin{aligned} \frac{a}{\sin A} = \frac{b}{\sin B} &\Rightarrow \frac{a}{b} = \frac{\sin A}{\sin B} \\ a > b &\Rightarrow \frac{a}{b} > 1 \end{aligned} \right\} \Rightarrow \frac{\sin A}{\sin B} > 1 \Rightarrow A, B, C \in (0, \pi) \Rightarrow \sin B > 0 \Rightarrow \sin A > \sin B \\
 \Rightarrow \sin A - \sin B > 0 &\Rightarrow 2 \sin \frac{A-B}{2} \cos \frac{A+B}{2} > 0 \Rightarrow \frac{A+B}{2} = \frac{180^\circ - C}{2} \\
 &= 90^\circ - \frac{C}{2}.
 \end{aligned}$$

$$\cos \frac{A+B}{2} = \cos \left( 90^{\text{circ}} - \frac{C}{2} \right) = \sin \frac{C}{2} > 0, \text{ therefore } \frac{A-B}{2} > 0 \Rightarrow A > B;$$

$$\left( -\frac{\pi}{2} < \frac{A-B}{2} < \frac{\pi}{2} \right).$$

Solution to [Problem 59](#).

a)  $a = 2R \sin A, b = 2R \sin B$

$$\frac{2R \sin A \cos A - 2R \sin B \cos B}{2R \sin A \cos B - 2R \sin B \cos A} + \cos C = \cos C + \frac{\sin A \cos A - \sin B \cos B}{\sin A \cos B - \sin B \cos A} =$$

$$= \frac{\frac{1}{2} \sin 2A - \frac{1}{2} \sin 2B}{\sin(A-B)} + \cos C = \frac{1}{2} \cdot \frac{2 \sin(A-B) \cos(A+B)}{\sin(A-B)} + \cos C =$$

$$\cos(A+B) + \cos C = \cos(180^\circ - C) + \cos C = -\cos C + \cos C = 0$$

b. We transform the product into a sum:

$$\sin(A-B) \sin C = \frac{\cos(A-B-C) - \cos(A-B+C)}{2} \stackrel{*}{=} \frac{1}{2} [-\cos 2A + \cos 2B] =$$

$$(B+C = 180^\circ - A, \quad A+C = 180^\circ - B)$$

$$= \frac{a^2 - b^2}{4R^2}; \quad (1)$$

$$1 + \cos(A-B) \cos C = 1 + \frac{\cos(A-B+C) + \cos(A-B-C)}{2} \stackrel{*}{=} \\ = \frac{2 + \cos(180 - 2B) + \cos(2A - 180)}{2}$$

$$(A+B = 180^\circ - B, \quad B+C = 180^\circ - A)$$

$$\stackrel{*}{=} \frac{2 - \cos 2B - \cos 2A}{2} = \frac{2 - 1 + 2 \sin^2 B - 1 + 2 \sin^2 A}{2} = \sin^2 A + \sin^2 B = \left( \frac{a}{2R} \right)^2 +$$

$$+ \left( \frac{b}{2R} \right)^2 = \frac{a^2 + b^2}{4R^2} \quad (2)$$

From (1) and (2)  $\Rightarrow$

$$\frac{\frac{a^2 - b^2}{4R^2}}{\frac{a^2 + b^2}{4R^2}} = \frac{a^2 - b^2}{a^2 + b^2}$$

$$c) (a+c) \cos \frac{B}{4} + b \cos \left( A + \frac{3B}{4} \right) = a \cos \frac{B}{4} + b \cos \frac{B}{4} + b \cos \left( A + \frac{3B}{4} \right) = c \cos \frac{B}{4} + \\ + a \cos \left( B - \frac{3B}{4} \right) + b \cos \left( A + \frac{3B}{4} \right)$$

We consider the last two terms:



$$\begin{aligned}
 a \cos \left( B - \frac{3B}{4} \right) + b \cos \left( A + \frac{3B}{4} \right) &= 2R \sin A \cos \left( B - \frac{3B}{4} \right) + 2R \sin B \cos \left( A - \frac{3B}{4} \right) = \\
 &= 2R \left( \frac{\sin \left( A + B - \frac{3B}{4} \right) + \sin \left( A - B + \frac{3B}{4} \right)}{2} + \frac{\sin \left( A + B - \frac{3B}{4} \right) + \sin \left( A - B + \frac{3B}{4} \right)}{2} \right) = \\
 &= R \left[ \sin \left( A + B - \frac{3B}{4} \right) + \sin \left( A + B + \frac{3B}{4} \right) + \sin \left( A - B + \frac{3B}{4} \right) + \sin \left( A - B + \frac{3B}{4} \right) \right] = \\
 &= 2R \sin(A + B) \cos \frac{3B}{4} - 2R \sin(\pi - C) \cos \frac{3B}{4} + 2R \sin c \cos \frac{3B}{4} = c \cos \frac{3B}{4} + c \cos \frac{3B}{4} = \\
 &= c \left( \cos \frac{B}{4} + \cos \frac{3B}{4} \right) = 2c \cos \frac{B}{4} \cos \frac{3B}{4} = 2c \cos \frac{B}{2} \cos \frac{B}{2}
 \end{aligned}$$

Solution to [Problem 60](#).

We apply the law of cosines in triangle ABC:

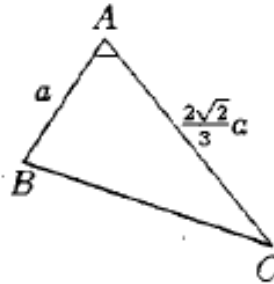

$$\begin{aligned}
 \|BC\|^2 &= a^2 + \frac{8}{9}a^2 - 2a \cdot \frac{2\sqrt{3}}{3} \cdot a \cdot \frac{\sqrt{2}}{2} = a^2 + \frac{8a^2}{9} - \frac{4a^2}{3} = \frac{5a^2}{9} \\
 \|BC\| &= \frac{a\sqrt{5}}{3} \\
 \|AC\|^2 &= \|AB\|^2 + \|BC\|^2 - 2\|AB\|\|BC\|\cos B \Rightarrow \frac{8a^2}{9} = a^2 + \frac{5a^2}{9} - 2a \cdot \frac{a\sqrt{5}}{3} \cdot \cos B \\
 \Rightarrow \frac{2a^2\sqrt{5}\cos B}{2} &= a^2 + \frac{5a^2}{9} - \frac{8a^2}{9} = \frac{6a^2}{9} \Rightarrow \cos B = \frac{6a^2}{9} \cdot \frac{3}{2a^2\sqrt{5}} = \frac{1}{\sqrt{5}} = \frac{\sqrt{5}}{5} \\
 \sin B &= \sqrt{1 - \cos^2 B} = \sqrt{1 - \frac{5}{25}} = \frac{2\sqrt{5}}{5} \\
 \operatorname{tg} B &= \frac{\sin B}{\cos B} = \frac{2\sqrt{5}}{5} \cdot \frac{5}{\sqrt{5}} = 2
 \end{aligned}$$

Solution to [Problem 61](#).

$$\begin{aligned}
 \|IA\| &= \|IB\| = \|IC\| = r \\
 \left. \begin{array}{l} IC' \perp AB \\ IA' \perp BC \end{array} \right\} &\Rightarrow IA'B'C' \text{ inscribable quadrilateral} \\
 m(\widehat{A'IC'}) &= 180 - \widehat{B} \Rightarrow \sin(\widehat{A'IC'}) = \sin \widehat{B} \\
 \text{Similarly, } \widehat{A'IB'} &= \sin C \text{ and } \widehat{C'IB'} = \sin A.
 \end{aligned}$$

$$\sigma[B'C'I] = \frac{r^2 \sin A}{2}$$

$$\frac{a}{\sin A} = 2R \Rightarrow \sin A = \frac{a}{2R}$$

$$\sigma[B'C'I] = \frac{r^2 \frac{a}{2R}}{2} = \frac{r^2 a}{4R}$$

In the same way,

$$\sigma[A'B'I] = \frac{r^2}{4R}(a + b + c)$$

$$\sigma[ABC] = s = rp$$

$$\frac{\sigma[A'B'I]}{\sigma[ABC]} = \frac{r^2(a + b + c)}{4R} \Rightarrow \frac{1}{rp} = \frac{r}{2R}$$

Solution to [Problem 62](#).

$$0 < A \Rightarrow \frac{A}{2} < \frac{\pi}{2} \Rightarrow \sin \frac{A}{2} > 0 ;$$

$$\left. \begin{aligned} \sin \frac{A}{2} &= \sqrt{\frac{1 - \cos A}{2}} \Rightarrow \sin^2 \frac{A}{2} = \frac{1 - \cos A}{2} \\ \cos A &= \frac{b^2 + c^2 - a^2}{2bc} \end{aligned} \right\}$$

$$\Rightarrow \sin^2 \frac{A}{2} = \frac{1 - \frac{b^2 + c^2 - a^2}{2bc}}{2} = \frac{a^2 - (b - c)^2}{4bc} \leq \frac{a^2}{4bc} \Rightarrow \sin \frac{A}{2} \leq \frac{a}{2\sqrt{bc}}.$$

Solution to [Problem 63](#).

$$C = \pi - (A + B)$$

$$\left. \begin{aligned} S &= \frac{a^2 \sin B \sin C}{2 \sin A} \\ A, B, C &\text{ are known} \end{aligned} \right\} \Rightarrow \text{We find } a.$$

$$\frac{a}{\sin a} = \frac{b}{\sin b} \Rightarrow b = \frac{a \sin B}{\sin A}. \text{ In the same way, we find } c.$$

Solution to [Problem 64](#).

$$A = \arccos \frac{4}{5} \Rightarrow \cos A = \frac{4}{5} \Rightarrow \sin A = \sqrt{1 - \frac{16}{25}} = \frac{3}{5}$$

$$a^2 + b^2 + c^2 - 2bc \cos A \Rightarrow 169 = 841 - 2bc \frac{4}{5} \Rightarrow \frac{8bc}{5} = 841 - 169 \Rightarrow$$

$$\Rightarrow bc = 420$$

$$b^2 + c^2 = 841 \} \Rightarrow \begin{cases} b = 21 \\ c = 20 \end{cases} \text{ or } \begin{cases} b = 20 \\ c = 21 \end{cases}$$

$$\frac{a}{\sin A} = \frac{b}{\sin B} \Rightarrow \sin B = \frac{b \sin A}{a}$$

We find  $B$ .

$$C = 180^\circ - (A + B)$$

$$\sin B = \frac{21 \cdot \frac{3}{5}}{13} = \frac{63}{65} \Rightarrow B = \arcsin \frac{63}{65}$$

$$C = 180^\circ - \left( \arccos \frac{4}{5} + \arcsin \frac{63}{65} \right) = 180^\circ - \left( \arcsin \frac{3}{5} + \arcsin \frac{63}{65} \right)$$

We find the sum.

Or

$$\sin B = \frac{20 \cdot \frac{3}{5}}{13} = \frac{12}{13} \Rightarrow B = \arcsin \frac{12}{13}$$

$$C = 180^\circ - \left( \underbrace{\arcsin \frac{3}{5}}_{\alpha} + \underbrace{\arcsin \frac{12}{13}}_{\beta} \right)$$

$$\sin(\alpha + \beta) = \sin \alpha \cos \beta + \sin \beta \cos \alpha = \frac{3}{5} \cdot \frac{5}{13} + \frac{12}{13} \cdot \frac{4}{5} = \frac{63}{65} \Rightarrow \alpha + \beta = \arcsin \frac{63}{65}$$

$$C = 180^\circ - \arcsin \frac{63}{65}$$

Solution to [Problem 65](#).

$$R = 8r \Rightarrow \frac{r}{R} = \frac{1}{8}$$

We already know that

$$\frac{r}{R} = 4 \sin \frac{A}{2} \sin \frac{B}{2} \sin \frac{C}{2}$$

$$\frac{1}{8} = 4 \sin \frac{A}{2} \frac{\cos \frac{B-C}{2} - \cos \frac{B+C}{2}}{2} \Rightarrow$$

$$\Rightarrow \frac{1}{8} = 2 \sin \frac{A}{2} \left( \cos \frac{2\pi}{6} - \cos \frac{180^\circ - A}{2} \right) \Rightarrow \frac{1}{8} = \sin \frac{A}{2} \left( \cos \frac{\pi}{3} - \sin \frac{A}{2} \right) \Rightarrow$$

$$\Rightarrow \frac{1}{8} = 2 \sin \frac{A}{2} \left( \frac{1}{2} - \sin \frac{A}{2} \right)$$

We write  $\sin \frac{A}{2} = t$ . We have

$$\frac{1}{8} = 2t \left( \frac{1}{2} - t \right) = t - 2t^2$$

$$1 = 8t - 16t^2 \Rightarrow 16t^2 - 8t + 1 = 0 \Rightarrow$$

$$4t - 1^2 = 0 \Rightarrow t = \frac{1}{4}$$

$$\sin \frac{A}{2} = \frac{1}{4}; \quad \cos \frac{A}{2} = \sqrt{1 - \frac{1}{16}} = \frac{\sqrt{15}}{4}$$

$$\sin A = 2 \sin \frac{A}{2} \cos \frac{A}{2} = \frac{\sqrt{15}}{8} \Rightarrow A = \arcsin \frac{\sqrt{15}}{8}$$

$$\begin{cases} B + C = \pi - \arcsin \frac{\sqrt{15}}{8} \\ B - C = \frac{2\pi}{3} \end{cases}$$

From this system we find  $B$  and  $C$ .

$$2B = \frac{5\pi}{3} - \arcsin \frac{\sqrt{15}}{8}$$

$$B = \frac{5\pi}{6} - \frac{1}{2} \arcsin \frac{\sqrt{15}}{8}$$

$$C = B - \frac{2\pi}{3} = \frac{5\pi}{6} - \frac{2\pi}{3} - \frac{1}{2} \arcsin \frac{\sqrt{15}}{8} = \frac{\pi}{6} - \frac{1}{2} \arcsin \frac{\sqrt{15}}{8}$$

## Other Problems in Geometry and Trigonometry (10<sup>th</sup> grade)

66. Show that a convex polygon can't have more than three acute angles.

[Solution to Problem 66](#)

67. Let  $ABC$  be a triangle. Find the locus of points  $M \in (ABC)$ , for which

$$\sigma[ABM] = \sigma[ACM].$$

[Solution to Problem 67](#)

68. A convex quadrilateral  $ABCD$  is given. Find the locus of points  $M \in$

$$int.ABCD, \text{ for which } \sigma[MBCD] = \sigma[MBAD].$$

[Solution to Problem 68](#)

69. Determine a line  $MN$ , parallel to the bases of a trapezoid  $ABCD$  ( $M \in$

$|AD|, N \in |BC|$ ) such that the difference of the areas of  $[ABNM]$  and  $[MNCD]$

to be equal to a given number.

[Solution to Problem 69](#)

70. On the sides of  $\Delta ABC$  we take the points  $D, E, F$  such that  $\frac{BD}{DC} = \frac{CE}{EA} = \frac{AF}{FB} = 2$ .

Find the ratio of the areas of triangles  $DEF$  and  $ABC$ .

[Solution to Problem 70](#)

71. Consider the equilateral triangle  $ABC$  and the disk  $[C(O, \frac{a}{3})]$ , where  $O$  is the orthocenter of the triangle and  $a = \|AB\|$ . Determine the area  $[ABC] -$

$$[C(O, \frac{a}{3})].$$

[Solution to Problem 71](#)

72. Show that in any triangle  $ABC$  we have:

a.  $1 + \cos A \cos(B - C) = \frac{b^2 + c^2}{4R^2}$ ;

b.  $(b^2 + c^2 = a^2) \tan A = 4S$ ;

c.  $\frac{b+c}{2c \cos \frac{A}{2}} = \frac{\sin(\frac{A+C}{2})}{\sin(A+B)}$ ;

d.  $p = r \left( \cot \frac{A}{2} + \cot \frac{B}{2} + \cot \frac{C}{2} \right)$ ;

e.  $\cot \frac{A}{2} + \cot \frac{B}{2} + \cot \frac{C}{2} = \frac{p}{r}$ .

[Solution to Problem 72](#)

73. If  $H$  is the orthocenter of triangle  $ABC$ , show that:

a.  $\|AH\| = 2R \cos A$ ;

b.  $a\|AH\| + b\|BH\| + c\|CH\| = 4S$ .

[Solution to Problem 73](#)

74. If  $O$  is the orthocenter of the circumscribed circle of triangle  $ABC$  and  $I$  is the center of the inscribed circle, show that  $\|OI\|^2 = R(R - 2r)$ .

[Solution to Problem 74](#)

75. Show that in any triangle  $ABC$  we have:  $\cos^2 \frac{B-C}{2} \geq \frac{2r}{R}$ .

[Solution to Problem 75](#)

76. Find  $z^n + \frac{1}{z^n}$  knowing that  $z + \frac{1}{z} = 2 \sin \alpha$ .

[Solution to Problem 76](#)

77. Solve the equation:  $(z + 1)^n - (z - 1)^n = 0$ .

[Solution to Problem 77](#)

78. Prove that if  $z < \frac{1}{2}$  then  $|(1 + i)z^3 + iz| \leq \frac{3}{4}$ .

[Solution to Problem 78](#)

79. One gives the lines  $d$  and  $d'$ . Show that through each point in the space passes a perpendicular line to  $d$  and  $d'$ .

[Solution to Problem 79](#)

80. There are given the lines  $d$  and  $d'$ , which are not in the same plane, and the points  $A \in d, B \in d'$ . Find the locus of points  $M$  for which  $\text{pr}_d M = A$  and  $\text{pr}_{d'} M = B$ .

[Solution to Problem 80](#)

81. Find the locus of the points inside a trihedral angle  $\widehat{abc}$  equally distant from the edges of  $a, b, c$ .

[Solution to Problem 81](#)

82. Construct a line which intersects two given lines and which is perpendicular to another given line.

[Solution to Problem 82](#)

83. One gives the points  $A$  and  $B$  located on the same side of a plane; find in this plane the point for which the sum of its distances to  $A$  and  $B$  is minimal.

[Solution to Problem 83](#)

84. Through a line draw a plane onto which the projections of two lines to be parallel.

[Solution to Problem 84](#)

85. Consider a tetrahedron  $[ABCD]$  and centroids  $L, M, N$  of triangles  $BCD, CAD, ABD$ .

a. Show that  $(ABC) \parallel (LMN)$ ;

b. Find the ratio  $\frac{\sigma[ABC]}{\sigma[LMN]}$ .

[Solution to Problem 85](#)

86. Consider a cube  $[ABCD A' B' C' D']$ . The point  $A$  is projected onto  $A' B, A' C, A' D$  respectively in  $A_1, A_2, A_3$ . Show that:
- $A' C \perp (A_1 A_2 A_3)$ ;
  - $AA_1 \perp A_1 A_2, AA_3 \perp A_3 A_2$ ;
  - $AA_1 A_2 A_3$  is an inscribable quadrilateral.

[Solution to Problem 86](#)

87. Consider the right triangles  $BAC$  and  $ABD$  ( $m(\widehat{BAC}) = m(\widehat{ABD}) = 90^\circ$ ) located on perpendicular planes  $M$  and  $N$ , being midpoints of segments  $[AB], [CD]$ . Show that  $MN \perp CD$ .

[Solution to Problem 87](#)

88. Prove that the bisector half-plane of a dihedral angle inside a tetrahedron divides the opposite edge in proportional segments with the areas of the adjacent faces.

[Solution to Problem 88](#)

89. Let  $A$  be a vertex of a regular tetrahedron and  $P, Q$  two points on its surface. Show that  $m(\widehat{PAQ}) \leq 60^\circ$ .

[Solution to Problem 89](#)

90. Show that the sum of the measures of the dihedral angles of a tetrahedron is bigger than  $360^\circ$ .

[Solution to Problem 90](#)

91. Consider lines  $d_1, d_2$  contained in a plane  $\alpha$  and a line  $AB$  which intersects plane  $\alpha$  at point  $C$ . A variable line, included in  $\alpha$  and passing through  $C$  all  $d_1, d_2$  respectively at  $MN$ . Find the locus of the intersection  $AM \cap BN$ . In which case is the locus an empty set?

[Solution to Problem 91](#)



92. A plane  $\alpha$  intersects sides  $[AB], [BC], [CD], [DA]$  of a tetrahedron  $[ABCD]$  at points  $L, M, N, P$ . Prove that  $\|AL\| \cdot \|BM\| \cdot \|CN\| \cdot \|PD\| = \|BL\| \cdot \|CM\| \cdot \|DN\| \cdot \|AP\|$ .

[Solution to Problem 92](#)

93. From a point  $A$  located outside a plane  $\alpha$ , we draw the perpendicular line  $AO, O \in \alpha$ , and we take  $B, C \in \alpha$ . Let  $H, H_1$  be the orthocenters of triangles  $ABC, OBC$ ;  $AD$  and  $BE$  heights in triangle  $ABC$ ; and  $BE_1$  height in triangle  $OBC$ . Show that:

- a.  $HH_1 \perp (ABC)$ ;
- b.  $\left\| \frac{OA}{AD} \right\| \cdot \left\| \frac{DH_1}{H_1B} \right\| \cdot \left\| \frac{BE}{EE_1} \right\| = 1$ .

[Solution to Problem 93](#)

94. Being given a tetrahedron  $[ABCD]$  where  $AB \perp CD$  and  $AC \perp BD$ , show that:

- a.  $\|AB\|^2 + \|CD\|^2 = \|BC\|^2 + \|AD\|^2 = \|CA\|^2 + \|BD\|^2$ ;
- b. The midpoints of the 6 edges are located on a sphere.

[Solution to Problem 94](#)

95. It is given a triangular prism  $[ABCA'B'C']$  which has square lateral faces. Let  $M$  be a mobile point  $[AB']$ ,  $N$  the projection of  $M$  onto  $(BCC')$  and  $A''$  the midpoint of  $[B'C'']$ . Show that  $A'N$  and  $MA''$  intersect in a point  $P$  and find the locus of  $P$ .

[Solution to Problem 95](#)

96. We have the tetrahedron  $[ABCD]$  and let  $G$  be the centroid of triangle  $BCD$ . Show that if  $M \in AG$  then  $v[MGBC] = v[MGCD] = v[MGDB]$ .

[Solution to Problem 96](#)

97. Consider point  $M \in$  the interior of a trirectangular tetrahedron with its vertex in  $O$ . Draw through  $M$  a plane which intersects the edges of the

respective tetrahedron in points  $A, B, C$  so that  $M$  is the orthocenter of  $\triangle ABC$ .

[Solution to Problem 97](#)

98. A pile of sand has as bases two rectangles located in parallel planes and trapezoid side faces. Find the volume of the pile, knowing the dimensions  $a', b'$  of the small base,  $a, b$  of the larger base, and  $h$  the distance between the two bases.

[Solution to Problem 98](#)

99. A pyramid frustum is given, with its height  $h$  and the areas of the bases  $B$  and  $b$ . Unite any point  $\sigma$  of the larger base with the vertices  $A, B, A', B'$  of a side face. Show that  $v[OA'B'A] = \frac{\sqrt{6}}{\sqrt{B}}v[OABB']$ .

[Solution to Problem 99](#)

100. A triangular prism is circumscribed to a circle of radius  $R$ . Find the area and the volume of the prism.

[Solution to Problem 100](#)

101. A right triangle, with its legs  $b$  and  $c$  and the hypotenuse  $a$ , revolves by turns around the hypotenuse and the two legs,  $V_1, V_2, V_3$ ;  $S_1, S_2, S_3$  being the volumes, respectively the lateral areas of the three formed shapes, show that:

$$\begin{aligned} \text{a. } & \frac{1}{V_1^2} = \frac{1}{V_2^2} = \frac{1}{V_3^2}, \\ \text{b. } & \frac{S_2}{S_3} + \frac{S_3}{S_2} = \frac{S_2 + S_3}{S_1}. \end{aligned}$$

[Solution to Problem 101](#)

102. A factory chimney has the shape of a cone frustum and  $10m$  height, the bases of the cone frustum have external lengths of  $3,14m$  and  $1,57m$ , and the wall is  $18cm$  thick. Calculate the volume of the chimney.

[Solution to Problem 102](#)

103. A regular pyramid, with its base a square and the angle from the peak of a side face of measure  $\alpha$  is inscribed in a sphere of radius  $R$ . Find:
- the volume of the inscribed pyramid;
  - the lateral and total area of the pyramid;
  - the value  $\alpha$  when the height of the pyramid is equal to the radius of the sphere.

[Solution to Problem 103](#)

## Solutions

Solution to [Problem 66](#).

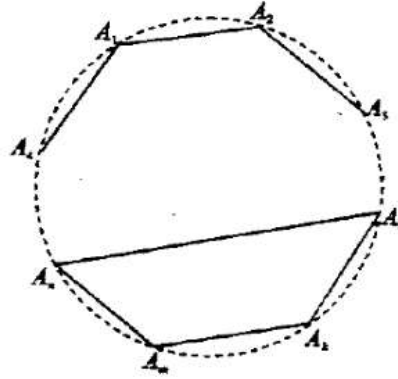

Let  $A_1, A_2 \dots A_n$  the vertices of the convex polygon. Let's assume that it has four acute angles. The vertices of these angles form a convex quadrilateral  $A_1A_2A_3A_n$ . Due to the fact that the polygon is convex, the segments  $|A_1A_2|$ ,  $|A_2A_3|$ ,  $|A_3A_n|$ ,  $|A_nA_1|$  are inside the initial polygon. We find that the angles of the quadrilateral are acute, which is absurd, because their sum is  $360^\circ$ .

*Another solution:* We assume that  $A_1A_2A_3A_n$  is a convex polygon with all its angles acute  $\Rightarrow$  the sum of the external angles is bigger than  $360^\circ$ , which is absurd (the sum of the measures of the external angles of a convex polygon is  $360^\circ$ ).

Solution to [Problem 67](#).

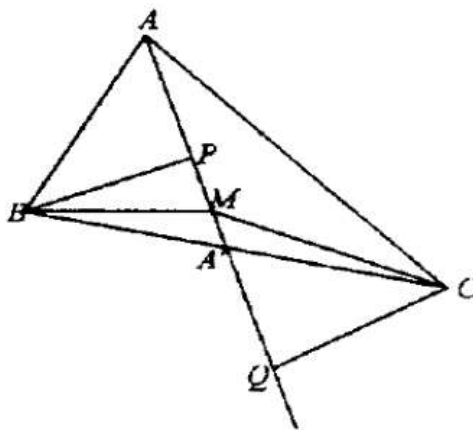

Let  $|AA'|$  be the median from  $A$  and  $CQ \perp AA'$ ,  $BP \perp AA'$ .

$\Delta BA'P \equiv CA'Q$  because:

$$\begin{cases} \widehat{PBC} \equiv \widehat{BCQ} & \text{alternate interior} \\ \widehat{PA'B} \equiv \widehat{CA'Q} & \text{vertical angles} \\ BA' \equiv A'C & \end{cases}$$

$\Rightarrow ||BP|| = ||CQ||$  and by its construction  $BP \perp AA'$ ,  $CQ \perp AA'$ .

The desired locus is median  $|AA'|$ . Indeed, for any  $M \in |AA'|$  we have  $\sigma[ABM] = \sigma[ACM]$ , because triangles  $ABM$  and  $ACM$  have a common side  $|AM|$  and its corresponding height equal  $||BP|| = ||CQ||$ .

*Vice-versa.* If  $\sigma[ABM] = \sigma[ACM]$ , let's prove that  $M \in |AA'|$ .

Indeed:  $\sigma[ABM] = \sigma[ACM] \Rightarrow d(B, AM) = d(C, AM)$ , because  $|AM|$  is a common side,  $d(B, AM) = ||BP||$  and  $d(C, AM) = ||CQ||$  and both are perpendicular to  $AM \Rightarrow PBQC$  is a parallelogram, the points  $P, M, Q$  are collinear ( $P, Q$  the feet of the perpendicular lines from  $B$  and  $C$  to  $AM$ ).

In parallelogram  $PBQC$  we have  $|PQ|$  and  $|BC|$  diagonals  $\Rightarrow AM$  passes through the middle of  $|BC|$ , so  $M \in |AA'|$ , the median from  $A$ .

Solution to [Problem 68](#).

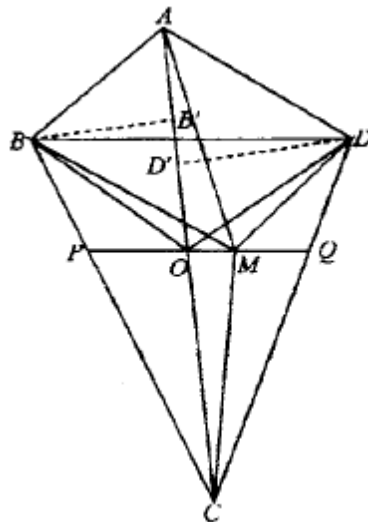

Let  $O$  be the midpoint of diagonal  $|AC| \Rightarrow ||AO|| = ||OC||$ .

$$\sigma[AOD] = \sigma[COD] \quad (1)$$

Because  $\begin{cases} ||AO|| = ||OC|| \\ ||OD'|| \text{ common height} \end{cases}$

$$\sigma[AOB] = \sigma[COB] \quad (2)$$

the same reasons; we add up (1) and (2)  $\Rightarrow$

$$\sigma[ADOB] = \sigma[DCBO] \quad (3),$$

so  $O$  is a point of the desired locus.

We construct through  $O$  a parallel to  $BD$  until it cuts sides  $|BC|$  and  $|DC|$  at  $P$  respectively  $Q$ . The desired locus is  $|PQ|$ .

Indeed  $(\forall)M \in |PQ|$  we have:

$$\sigma[MBAD] = \sigma[ABD] + \sigma[BDM] = \sigma[ABD] + \sigma[BOD] = \sigma[ABOD].$$

$\sigma[BDO] = \sigma[BDM]$  because  $M$  and  $Q$  belongs to a parallel to  $BD$ .

$$\begin{aligned} \sigma[BCDM] &= \sigma[PQC] + \sigma[PMB] + \sigma[MQD] = \sigma[PQC] + \sigma[PBO] + \sigma[OMB] + \\ \sigma[MQD] &\doteq \end{aligned}$$

$$\sigma[OMB] = \sigma[OMD]$$

$$\doteq \sigma[PQC] + \sigma[PBO] + \sigma[OMD] + \sigma[MQD] = \sigma[OBCD]$$

$B, D \in$  a parallel to  $OM$ .

$$\left. \begin{array}{l} \sigma[MBAD] = \sigma[ABOD] \\ \sigma[BCDM] = \sigma[OBCD] \\ \text{and from (3)} \end{array} \right\} \Rightarrow \sigma[MBAD] = \sigma[BCDM].$$

*Vice-versa:* If  $\sigma[MBCD] = \sigma[MBAD]$ , let's prove that  $M \in$  parallel line through  $O$  to  $BD$ . Indeed:

$$\left. \begin{array}{l} \sigma[BCDM] = \sigma[MBAD] \\ \text{and because } \sigma[BCDM] + \sigma[MBAD] = \sigma[ABCD] \end{array} \right\} \Rightarrow \sigma[MBCD] = \sigma[MBAD] = \frac{\sigma[ABCD]}{2} \quad (2).$$

So, from (1) and (2)  $\Rightarrow \sigma[MBAD] = \sigma[ABOD] \Rightarrow \sigma[ABD] + \sigma[BDO] = \sigma[ABD] + \sigma[BDM] \Rightarrow \sigma[BDM] \Rightarrow M$  and  $O$  are on a parallel to  $BD$ .

Solution to [Problem 69](#).

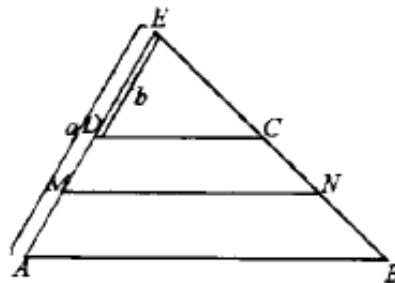

We write  $||EA|| = a$  and  $||ED|| = b, ||EM|| = x$ .

$$\frac{\sigma[EMN]}{\sigma[EDC]} = \frac{x^2}{b^2} \Rightarrow \frac{[MNCD]}{\sigma[EDC]} = \frac{x^2 - b^2}{b^2} \quad (2)$$

$$\frac{\sigma[EAB]}{\sigma[EDC]} = \frac{a^2}{b^2} \Rightarrow \frac{[ABCD]}{\sigma[EDC]} = \frac{a^2 - b^2}{b^2} \quad (3)$$

We subtract (2) from (3)

$$\begin{aligned} & \Rightarrow \frac{\sigma[ABCD] - \sigma[MNCD]}{\sigma[ECD]} = \\ & = \frac{a^2 - x^2}{b^2} \Rightarrow \frac{\sigma[ABNM]}{\sigma[ECD]} = \frac{a^2 - x^2}{b^2} \quad (4) \end{aligned}$$

We subtract (2) from (4)

$$\begin{aligned} & \Rightarrow \left. \frac{\sigma[ABNM] - \sigma[MNCD]}{\sigma[EDC]} = \frac{a^2 - x^2 - x^2 - b^2}{b^2} \right\} \Rightarrow \frac{k}{\sigma[EDC]} = \\ & \text{from the hypothesis } \sigma[ABNM] - \sigma[MNCD] = k \\ & = \frac{a^2 + b^2 - 2x^2}{b^2} \Rightarrow \frac{kb^2}{\sigma[EDC]} - a^2 - b^2 = -2x^2 \Rightarrow x^2 = \frac{(a^2 + b^2)\sigma[EDC] - kb^2}{\sigma[EDC]} \end{aligned}$$

From the relation (3), by writing  $[ABCD] - S \Rightarrow \sigma[ECD] = \frac{Sb^2}{a^2 - b^2}$ .

We substitute this in the relation of  $x^2$  and we obtain:

$$\begin{aligned} x^2 &= a^2 + b^2 - kb^2 \frac{a^2 - b^2}{Sb^2} \Rightarrow x^2 = \frac{(a^2 + b^2)s - k(a^2 - b^2)}{S} \Rightarrow \\ & \Rightarrow \left. \begin{aligned} x^2 &= \frac{(s-k)a^2 + (s+k)b^2}{S} \\ x &= \|EM\| \end{aligned} \right\} \Rightarrow \|EM\| = \sqrt{\frac{(s-k)a^2 + (s+k)b^2}{S}} \end{aligned}$$

and taking into consideration that  $\|EM\| = \|DM\| + b$ , we have

$$\|DM\| = \sqrt{\frac{(s-k)a^2 + (s+k)b^2}{S}}$$

so we have the position of point  $M$  on the segment  $|DA|$  (but it was sufficient to find the distance  $\|EM\|$ ).

Solution to [Problem 70](#).

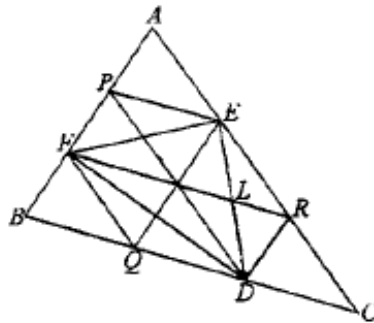

We remark from its construction that  $EQ \parallel AB \parallel RD$ , more than that, they are equidistant parallel lines. Similarly,  $EQ, PD, AC$  and  $AB, EQ, RD$  are also equidistant parallel lines.

$$(\|AP\| = \|PF\| = \|FB\|; \|AE\| = \|ER\| = \|RC\|, \\ \|BQ\| = \|QD\| = \|DC\|).$$

We write  $\sigma[BFQ] = S$ .

Based on the following properties:

- two triangles have equal areas if they have equal bases and the same height;
- two triangles have equal areas if they have the same base and the third peak on a parallel line to the base,

we have:

$$\sigma[ABC] = \sigma[AFE] + \sigma[FER] + \sigma[FBO] + \sigma[FRD] + \sigma[DRC] = 9S$$

$$\left. \begin{aligned} \sigma[FEL] &= \sigma[FER] - \sigma[ELR] = 2S - \sigma[ELR] \\ \sigma[FDL] &= \sigma[FRD] - \sigma[RLD] = 2S - \sigma[RLD] \end{aligned} \right\}$$

by addition  
 $\xrightarrow{\hspace{1.5cm}}$

$$\Rightarrow \sigma[DEF] = 4S - (\sigma[ELR] + \sigma[RLD]) = 4S - S = 3S.$$

$$\text{So } \frac{\sigma[DEF]}{\sigma[ABC]} = \frac{3S}{9S} = \frac{1}{3}.$$

(If necessary the areas  $S$  can be arranged).

Solution to [Problem 71](#).

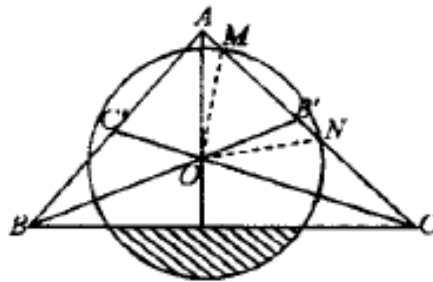

$$\|OB\| = \frac{a\sqrt{3}}{6} \quad (BB' \text{ median})$$

In  $\triangle MOB'$ :

$$\cos \widehat{MOB'} = \frac{\frac{a\sqrt{3}}{6}}{\frac{a}{3}} = \frac{\sqrt{3}}{2} \Rightarrow \mu(\widehat{MOB'}) = \frac{\pi}{6}.$$

$$\text{So } (\widehat{MON}) = \frac{\pi}{3}.$$

We mark with  $\Sigma$  the disk surface bordered by a side of the triangle outside the triangle.



$$\begin{aligned}\sigma[\Sigma] &= \sigma[\text{circle sector } MON] - \sigma[MON] \\ &= \frac{\pi a^2}{9 \cdot 6} - \frac{a^2}{9 \cdot 2} \sin 60^\circ = \frac{\pi a^2}{9 \cdot 6} - \frac{a^2 \sqrt{3}}{4 \cdot 9} = \frac{a^2}{18} \cdot \left( \frac{\pi}{3} - \frac{\sqrt{3}}{2} \right).\end{aligned}$$

If through the disk area we subtract three times  $\sigma[\Sigma]$ , we will find the area of the disk fraction from the interior of  $ABC$ . So the area of the disk surface inside  $ABC$  is:

$$\frac{\pi a^2}{9} - 3 \frac{a^2}{18} \left( \frac{\pi}{3} - \frac{\sqrt{3}}{2} \right) = \frac{\pi a^2}{9} - \frac{\pi a^2}{18} + \frac{a^2 \sqrt{3}}{12} = \frac{\pi a^2}{18} + \frac{a^2 \sqrt{3}}{12}.$$

The desired area is obtained by subtracting the calculated area from  $\sigma[ABC]$ .

So:

$$\frac{a^2 \sqrt{3}}{4} - \frac{\pi a^2}{18} - \frac{2a^2 \sqrt{3}}{12} = \frac{2a^2 \sqrt{3}}{12} - \frac{\pi a^2}{18} = \frac{a^2 \sqrt{3}}{6} - \frac{\pi a^2}{18} = \frac{a^2}{18} (3\sqrt{3} - \pi).$$

Solution to [Problem 72](#).

a.  $1 + \cos A \cdot \cos(B - C) = \frac{b^2 + c^2}{4R^2}$

$$\begin{aligned}1 + \cos A \cos(B - C) &= 1 + \cos[\pi - (C + B)] \cos(B - C) = 1 - \cos(B + C) \cdot \cos(B - C) = \\ 1 - \frac{1}{2}[\cos 2B + \cos 2C] &= 1 - \frac{1}{2}[2 \cos^2 B - 1 + 2 \cos^2 C - 1] = 2 - \cos^2 B - \cos^2 C = \sin^2 B + \\ + \sin^2 C &\stackrel{\text{di n T. sin}}{=} \frac{b^2}{4R^2} + \frac{c^2}{4R^2} = \frac{b^2 + c^2}{4R^2}.\end{aligned}$$

b. We prove that  $\tan A = \frac{4S}{b^2 + c^2 - a^2}$ .

$$\begin{aligned}\operatorname{tg} A &= \frac{\sin A}{\cos A} = \frac{2 \sin \frac{A}{2} \cos \frac{A}{2}}{2 \cos^2 \frac{A}{2} - 1} = \frac{2 \sqrt{\frac{p(p-a)(p-b)(p-c)}{(bc)^2}}}{\frac{2p(p-a)}{bc} - 1} = \frac{2S}{bc \left( \frac{2p(p-a) - bc}{bc} \right)} = \\ &= \frac{2S}{bc \left( \frac{2p(p-a) - bc}{bc} \right)} = \frac{2S}{2 \frac{a+b+c}{2} \cdot \frac{b+c-a}{2} - bc} = \\ &= \frac{4S}{ab + ac - a^2 + b^2 + bc - ba + bc + c^2 - ac - 2bc} = \frac{4S}{b^2 + c^2 - a^2}.\end{aligned}$$

$$\begin{aligned}\text{c) } \frac{b+c}{2c \cos \frac{A}{2}} &= \frac{\sin(\frac{A}{2} + C)}{\sin(A+B)} \stackrel{A+B=\pi-C}{\implies} \frac{b+c}{2c \cos \frac{A}{2}} = \frac{\sin(\frac{A}{2} + C)}{\sin C} \implies \\ \implies \frac{b+c}{2c \cos \frac{A}{2}} &= \frac{\sin A \cos C + \sin C \cos \frac{A}{2}}{\sin C} \implies (b+c) \sin C = 2C \sin \frac{A}{2} \cos \frac{A}{2} \cos C + \\ 2c \sin C \cos^2 \frac{A}{2} &\implies (b+c) \sin C = c \sin A \cos C + 2c \sin C \cos^2 \frac{A}{2}\end{aligned}$$

$$\begin{aligned} \frac{a}{\sin A} = \frac{b}{\sin B} = \frac{c}{\sin C} = 2R &\Rightarrow (b+c)\frac{ac}{2k} \cos C = \frac{2c^2 \cos^2 \frac{A}{2}}{2R} \Rightarrow \\ \Rightarrow b+c = a \cos C + 2 \cos^2 \frac{A}{2} &\Rightarrow b+c = a \frac{a^2+b^2-c^2}{2ab} + 2c \frac{p(p-a)}{bc} \Rightarrow b+c = \\ = \frac{a^2+b^2-c^2}{2b} + \frac{2p(p-a)}{b} &\Rightarrow 2b^2+2bc = a^2+b^2-c^2+(a+b+c)(c+b-a) \Rightarrow \\ &\Rightarrow \text{All terms reduce.} \end{aligned}$$

d. Let's prove that  $\cot \frac{A}{2} + \cot \frac{B}{2} + \cot \frac{C}{2} = \frac{p}{r}$ .

Indeed

$$\begin{aligned} \cot \frac{A}{2} + \cot \frac{B}{2} + \cot \frac{C}{2} &= \cot \frac{A}{2} \cdot \cot \frac{B}{2} \cdot \cot \frac{C}{2} = \sqrt{\frac{p(p-a)}{(p-b)(p-c)}} \\ \cdot \sqrt{\frac{p(p-b)}{(p-a)(p-c)}} \cdot \sqrt{\frac{p(p-c)}{(p-a)(p-b)}} &= p \sqrt{\frac{p(p-a)(p-b)(p-c)}{(p-a)^2(p-b)^2(p-c)^2}} = \frac{p^2}{S} \stackrel{S=pr}{=} \frac{p^2}{pr} = \frac{p}{r}. \end{aligned}$$

We now have to prove that:

$$\begin{aligned} \cot \frac{A}{2} + \cot \frac{B}{2} + \cot \frac{C}{2} &= \cot \frac{A}{2} \cdot \cot \frac{B}{2} \cdot \cot \frac{C}{2} \Leftrightarrow \\ \frac{1}{\operatorname{tg} \frac{A}{2}} + \frac{1}{\operatorname{tg} \frac{B}{2}} + \operatorname{tg} \frac{A+B}{2} &= \frac{1}{\operatorname{tg} \frac{A}{2} \cdot \operatorname{tg} \frac{B}{2}} \cdot \operatorname{tg} \frac{A+B}{2} \Leftrightarrow \frac{\operatorname{tg} \frac{A}{2} + \operatorname{tg} \frac{B}{2}}{\operatorname{tg} \frac{A}{2} \cdot \operatorname{tg} \frac{B}{2}} + \\ + \frac{\operatorname{tg} \frac{A}{2} + \operatorname{tg} \frac{B}{2}}{1 - \operatorname{tg} \frac{A}{2} \cdot \operatorname{tg} \frac{B}{2}} &= \frac{1}{\operatorname{tg} \frac{A}{2} \cdot \operatorname{tg} \frac{B}{2}} \cdot \frac{\operatorname{tg} \frac{A}{2} + \operatorname{tg} \frac{B}{2}}{1 - \operatorname{tg} \frac{A}{2} \cdot \operatorname{tg} \frac{B}{2}} \Leftrightarrow \frac{1}{\operatorname{tg} \frac{A}{2} \cdot \operatorname{tg} \frac{B}{2}} + \frac{1}{1 - \operatorname{tg} \frac{A}{2} \cdot \operatorname{tg} \frac{B}{2}} = \\ \frac{1}{\operatorname{tg} \frac{A}{2} \cdot \operatorname{tg} \frac{B}{2} \cdot (1 - \operatorname{tg} \frac{A}{2} \cdot \operatorname{tg} \frac{B}{2})} &\Leftrightarrow \frac{1 - \operatorname{tg} \frac{A}{2} \cdot \operatorname{tg} \frac{B}{2} + \operatorname{tg} \frac{A}{2} \cdot \operatorname{tg} \frac{B}{2}}{\operatorname{tg} \frac{A}{2} \cdot \operatorname{tg} \frac{B}{2} \cdot (1 - \operatorname{tg} \frac{A}{2} \cdot \operatorname{tg} \frac{B}{2})} = \\ = \frac{1}{\operatorname{tg} \frac{A}{2} \cdot \operatorname{tg} \frac{B}{2} \cdot (1 - \operatorname{tg} \frac{A}{2} \cdot \operatorname{tg} \frac{B}{2})} &\quad (a) \end{aligned}$$

q.e.d.

Solution to [Problem 73](#).

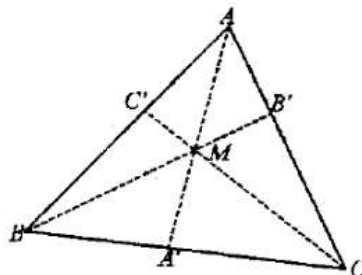

a. In triangle  $ABB'$ :  $\|AB'\| = c \cos A$

In triangle  $AHB'$ :

$$\begin{aligned} \cos \widehat{HAB'} &= \|AB'\| : \|AH\| \Rightarrow \|AH\| = \\ &= \frac{\|AB'\|}{\cos \widehat{HAB'}} = \frac{\|AB'\|}{\cos\left(\frac{\pi}{2} - C\right)} = \frac{c \cos A}{\sin C} \stackrel{T. \sin}{=} \frac{c \cos A}{\frac{c}{2R}} = \\ &= 2R \cos A \Rightarrow \|AH\| = 2R \cos A. \end{aligned}$$

b)  $a\|AH\| + b\|BH\| + c\|CH\| = 2R(a \cos A + b \cos B + c \cos C) \stackrel{T. \sin}{=} 4R^2(\sin A \cos A + \sin B \cos B + \sin C \cos C) = 2R^2(\sin 2A + \sin 2B + \sin 2C)$ .

We used:

$$\sin 2A + \sin 2B + \sin 2C = 4 \sin A \sin B \sin C.$$

$$\begin{aligned} \sin 2A + \sin 2B + \sin 2C &= \underbrace{2 \sin(A+B)}_{\sin C} \cos(A-B) + 2 \sin C \cos C = \\ &= 2 \sin C [\cos(A-B) - \cos(A+B)] = 2 \sin C \cdot 2 \sin A \sin B = 4 \sin A \sin B \sin C. \end{aligned}$$

Solution to [Problem 74](#).

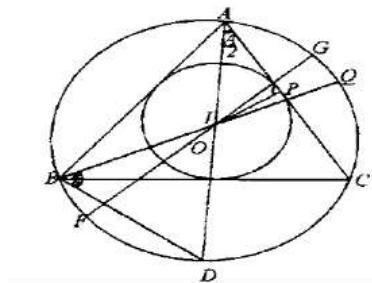

Using the power of point  $I$  in relation to circle  $C(O, R)$

$$\Rightarrow \|IG\| \cdot \|IF\| = \|AI\| \cdot \|ID\| \quad (1)$$

$$\begin{aligned} \|IG\| \cdot \|IF\| &= (R - \|OI\|)(\|R + \|OI\|) \Rightarrow \\ \|IG\| \cdot \|IF\| &= R^2 - \|OI\|^2. \end{aligned}$$

Taking into consideration (1), we have  $\|IA\| \cdot \|ID\| = R^2 - \|OI\|^2$ .

We now find the distances  $\|IA\|$  and  $\|ID\|$

In triangle  $\Delta IAP$ ,

$$\|IA\| = \frac{r}{\sin \frac{A}{2}} \quad (2)$$

We also find  $\|ID\|$ :  $\mu(\widehat{BID}) = \mu(\widehat{DBI})$  have the same measure, more exactly:

$$\mu(\widehat{BID}) = \frac{m(\widehat{BD}) + m(\widehat{AQ})}{2} = \frac{m(\widehat{A}) + m(\widehat{B})}{2}$$

$$m\left(\frac{\widehat{DCQ}}{2}\right) = m(\widehat{DBI}) \text{ Deci } \|ID\| = \|BD\|. \quad (3)$$

In  $\triangle ABD$  according to the law of sine, we have:

$$\frac{\|BD\|}{\sin \frac{A}{2}} = 2R \Rightarrow \|BD\| = 2R \sin \frac{A}{2}.$$

So taking into consideration (3),

$$\|ID\| = 2R \sin \frac{A}{2}. \quad (4)$$

Returning to the relation  $\|IA\| \cdot \|ID\| = R^2 - \|OI\|^2$ . with (2) and (4) we have:

$$\frac{r}{\sin \frac{A}{2}} \cdot 2R \sin \frac{A}{2} =$$

$$R^2 - \|IO\|^2 \Rightarrow \|IO\|^2 = R^2 - 2Rr \Rightarrow \|IO\|^2 = R(R - 2r).$$

Solution to [Problem 75](#).

$$r = 4R \sin \frac{A}{2} \sin \frac{B}{2} \sin \frac{C}{2} \Rightarrow r = 2R \sin \frac{A}{2} \left( \cos \frac{B-C}{2} - \underbrace{\cos \frac{B+C}{2}}_{\sin \frac{A}{2}} \right) \Rightarrow$$

$$r = 2R \sin \frac{A}{2} \cos \frac{B-C}{2} - 2R \sin^2 \frac{A}{2} \Rightarrow 2R \sin^2 \frac{A}{2} - 2R \sin \frac{B}{2} \cdot \cos \frac{B-C}{2} + r \geq 0 \Rightarrow$$

$$\Rightarrow \Delta \geq 0 \Rightarrow 4R^2 \cos^2 \frac{B-C}{2} - 8Rr \geq 0 \Rightarrow R^2 \cos^2 \frac{B-C}{2} - 2Rr \geq 0 \Rightarrow \cos^2 \frac{B-C}{2} \geq \frac{2r}{R}$$

*Note.* We will have to show that

$$\sin \frac{A}{2} \sin \frac{B}{2} \sin \frac{C}{2} = \frac{r}{4R}.$$

Indeed:

$$\sin \frac{A}{2} \sin \frac{B}{2} \sin \frac{C}{2} = \sqrt{\frac{(p-b)(p-c)}{bc} \cdot \frac{(p-a)(p-c)}{ac} \cdot \frac{(p-a)(p-b)}{ab}} =$$

$$= \frac{p(p-a)(p-b)(p-c)}{pabc} = \frac{S^2}{p4RS} = \frac{pr}{p4R} = \frac{r}{4R}$$

(by Heron's formula).

Solution to [Problem 76](#).

$$z + \frac{1}{z} = 2 \sin a \Rightarrow z^2 - 2(\sin a)z + 1 = 0 \Rightarrow z_{1,2} = \frac{\sin a \pm \sqrt{\sin^2 a - 1}}{1}$$

$$\Rightarrow z_{1,2} = \sin a \pm \sqrt{-\cos^2 a} \Rightarrow z_{1,2} = \sin a \pm i \cos a$$

So:

$$z_1 = \sin a + i \cos a$$

$$z_2 = \sin a - i \cos a = \bar{z}_1$$

We calculate for  $z_1$  and  $z_2$ :

$$z_1^n + \frac{1}{z_1^n} = z_1^n + \left(\frac{1}{z_1}\right)^n = z_1^n + z_2^n, \quad z^n + \frac{1}{z^n}$$

so  $z^n + \frac{1}{z^n}$  takes the same value for  $z_1$  and for  $z_2$  and it is enough if we calculate it for  $z_1$ .

$$\begin{aligned} z_1^n + \frac{1}{z_1^n} &= (\sin a + i \cos a)^n + \frac{1}{(\sin a + i \cos a)^n} = [\cos\left(\frac{\pi}{2} - a\right) + i \sin\left(\frac{\pi}{2} - a\right)]^n + \\ &+ \frac{1}{[\cos\left(\frac{\pi}{2} - a\right) + i \sin\left(\frac{\pi}{2} - a\right)]^n} = \cos[n\left(\frac{\pi}{2} - a\right)] + i \sin[n\left(\frac{\pi}{2} - a\right)] + \\ &+ \cos[n\left(\frac{\pi}{2} - a\right)] - i \sin[n\left(\frac{\pi}{2} - a\right)] = 2 \cos[n\left(\frac{\pi}{2} - a\right)] \stackrel{\text{cos. par}}{=} 2 \cos\left(na - \frac{a\pi}{2}\right). \end{aligned}$$

Analogously:

$$z_2^n + \bar{z}_2^n = 2 \cos[n\left(a - \frac{\pi}{2}\right)].$$

Solution to [Problem 77](#).

$$\begin{aligned} (z+1)^n - (z-1)^n &= a \Rightarrow (z+1)^n = (z-1)^n + a \Rightarrow \left(\frac{z+1}{z-1}\right)^n = 1 + \frac{a}{(z-1)^n} \Rightarrow \\ \Rightarrow \frac{z+1}{z-1} &= \sqrt[n]{1 + \frac{a}{(z-1)^n}} \Rightarrow \frac{z+1}{z-1} = \cos \frac{2k\pi}{n} + i \sin \frac{2k\pi}{n} \Rightarrow \\ \Rightarrow z+1 &= \left(\cos \frac{2k\pi}{n} + i \sin \frac{2k\pi}{n}\right) z - \left(\cos \frac{2k\pi}{n} + i \sin \frac{2k\pi}{n}\right) \Rightarrow \\ \Rightarrow \left(\cos \frac{2k\pi}{n} + i \sin \frac{2k\pi}{n} - 1\right) z &= \left(1 + \cos \frac{2k\pi}{n} + i \sin \frac{2k\pi}{n}\right) \Rightarrow \\ \Rightarrow \left(-2 \sin^2 \frac{k\pi}{n} + 2i \sin \frac{k\pi}{n} \cos \frac{k\pi}{n}\right) z &= 2 \cos^2 \frac{k\pi}{n} + 2i \sin \frac{k\pi}{n} \cos \frac{k\pi}{n} \Rightarrow \\ \Rightarrow z &= \frac{2 \cos \frac{k\pi}{n} \left(\cos \frac{k\pi}{n} + i \sin \frac{k\pi}{n}\right)}{-2 \sin^2 \frac{k\pi}{n} + 2i \sin \frac{k\pi}{n} \cos \frac{k\pi}{n}} = \end{aligned}$$

(we substitute  $-1$  with  $i^2$  at denominator)

$$= \frac{2 \cos \frac{k\pi}{n} \left( \cos \frac{k\pi}{n} + i \sin \frac{k\pi}{n} \right)}{2i \sin \frac{k\pi}{n} \left( \cos \frac{k\pi}{n} + i \sin \frac{k\pi}{n} \right)} = \frac{\cos k\pi}{i \sin \frac{k\pi}{n}} = \frac{i}{i^2} \operatorname{ctg} \frac{k\pi}{n} = -i \operatorname{ctg} \frac{k\pi}{n}.$$

Solution to [Problem 78](#).

$$\begin{aligned} |(1+i)z^3 + iz| &\leq |(1+i)z^3| + |iz| = |1+i| \cdot |z^3| + |i| \cdot |z| = \\ &\stackrel{|1+i|=2}{=} \stackrel{|i|=1}{=} 2|z^3| + |z| \stackrel{ip.}{\leq} 2 \cdot \frac{1}{8} + \frac{1}{2} = \frac{1}{4} + \frac{1}{2} = \frac{3}{4} \Rightarrow |(1+i)z^3 + iz| \leq \frac{3}{4}. \end{aligned}$$

Solution to [Problem 79](#).

We construct  $\alpha \perp d$  and  $A \in \alpha$ . The so constructed plane is unique. Similarly we construct  $\beta \perp d'$  and  $A \in \beta$ ,  $\alpha \cap \beta = a \ni A$ .

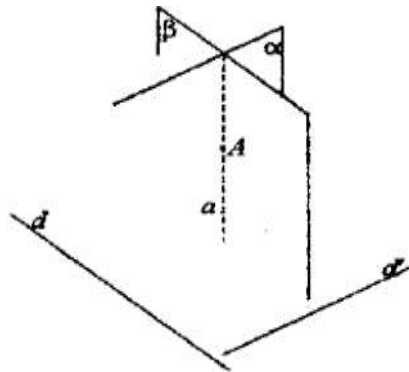

From  $\left. \begin{array}{l} \alpha \perp d \Rightarrow d \perp a \\ \beta \perp d' \Rightarrow d' \perp a \end{array} \right\} \Rightarrow a$  is a line which passes through  $A$  and is perpendicular to  $d$  and  $d'$ . The line  $a$  is unique, because  $\alpha$  and  $\beta$  constructed as above are unique.

Solution to [Problem 80](#).

We construct plane  $\alpha$  such that  $A \in \alpha$  and  $d \perp \alpha$ . We construct plane  $\beta$  such that  $B \in \beta$  and  $d' \perp \beta$ .

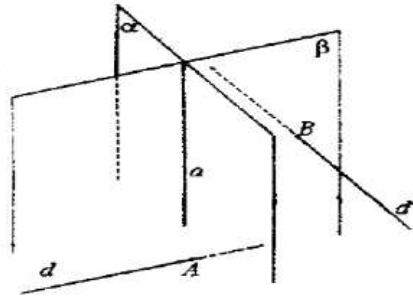

The so constructed planes  $\alpha$  and  $\beta$  are unique.

Let  $a = \alpha \cap \beta \Rightarrow a \subset \alpha$  so  $(\forall) M \in a$  has the property  $pr_d M = A$ .

$a \subset \beta \Rightarrow (\forall) M \in a$  has the property  $pr_{d'} M = B$ .

*Vice-versa.* If there is a point  $M$  in space such that  $pr_d M = A$  and  $pr_{d'} M = B \Rightarrow M \in a$  and  $M \in \beta \Rightarrow M \in \alpha \cap \beta \Rightarrow M \in a$  ( $\alpha$  and  $\beta$  previously constructed).

Solution to [Problem 81](#).

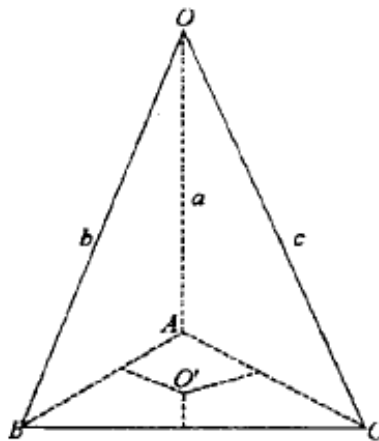

Let  $A \in a, B \in b, C \in c$  such that  $\|OA\| = \|OB\| = \|OC\|$ . Triangles  $OAB, OBC, OAC$  are isosceles. The mediator planes of segments  $\|AB\|, \|AC\|, \|BC\|$  pass through  $O$  and  $O'$  (the center of the circumscribed circle of triangle  $ABC$ ). Ray  $|OO'|$  is the desired locus.

Indeed  $(\forall) M \in |OO'| \Rightarrow M \in$  mediator plane of segments  $|AB|, |AC|$  and  $|BC| \Rightarrow M$  is equally distant from  $a, b$  and  $c$ .

*Vice-versa:*  $(\forall) M$  with the property:  $d(M, a) = d(M, b) = d(M, c) \Rightarrow M \in$  mediator plan, mediator planes of segments  $|AB|, |AC|$  and  $|BC| \Rightarrow M \in$  the intersection of these planes  $\Rightarrow M \in |OO'|$ .

Solution to [Problem 82](#).

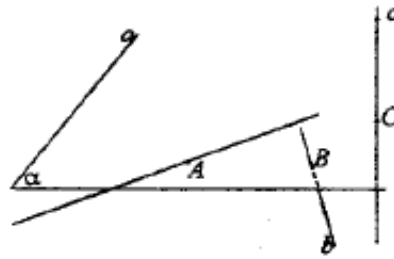

Let  $a, b, c$  be the 3 lines in space.

I. We assume  $a \perp c$  and  $b \perp c$ . Let  $\alpha$  be a plane such that:

$$\alpha \cap c = \{C\}$$

$$\alpha \cap a = \{A\} \text{ si } \alpha \perp c$$

$$\alpha \cap b = \{B\}$$

The construction is possible because  $a \perp c$  and  $b \perp c$ . Line  $AB$  meets  $a$  on  $p$  and it is perpendicular to  $c$ , because  $AB \subset \alpha$  and  $c \perp \alpha$ .

II. If  $a \perp c$  or  $b \perp c$ , the construction is not always possible, only if plane  $p(a, b)$  is perpendicular to  $c$ .

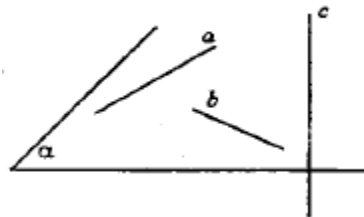

III. If  $a \perp c$  and  $b \perp c$ , we construct plane  $a \perp c$  so that  $a \subset \alpha$  and  $b \subset \alpha \neq \emptyset$ . Any point on line  $a$  connected with point  $b \cap \alpha$  is a desired line.

Solution to [Problem 83](#).

We construct  $A'$  the symmetrical point of  $A$  in relation to  $\alpha$ .  $A'$  and  $B$  are on different half-spaces,  $\alpha \cap |A'B| = O$ .

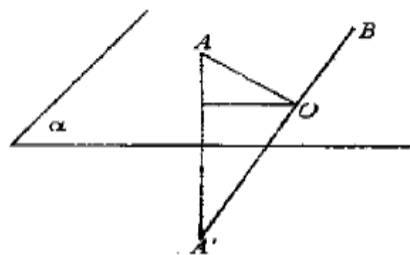



$O$  is the desired point, because  $\|OA\| + \|OB\| = \|OA'\| + \|OB\|$  is minimal when  $O \in |A'B|$ , thus the desired point is  $O = |A'B| \cap \alpha$ .

Solution to [Problem 84](#).

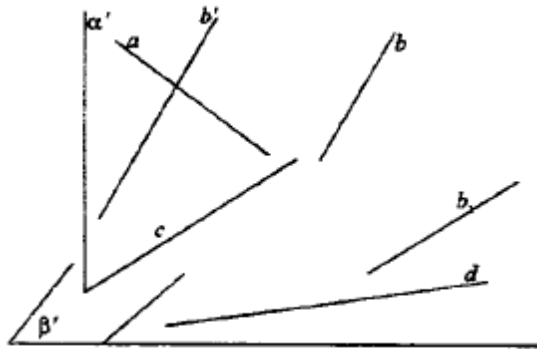

Let  $a, b, d$  be the 3 given lines and through  $d$  we construct a plane in which  $a$  and  $b$  to be projected after parallel lines.

Let  $A$  be an arbitrary point on  $a$ . Through  $A$  we construct line  $b' \parallel b$ . It results from the figure  $b \parallel \alpha, \alpha = p(a, b')$ .

Let  $\beta$  such that  $d \subset \beta$  and  $\beta \perp \alpha$ .

Lines  $a$  and  $b'$  are projected onto  $\beta$  after the same line  $c$ . Line  $b$  is projected onto  $\beta$  after  $b_1$  and  $b_1 \parallel c$ .

If  $b_1 \nparallel c$ ,

$$b_1 \nparallel c \Rightarrow s \cap b_1 = \{N\} \Rightarrow \alpha \cap p(b, b_1) \neq \emptyset \Rightarrow b \cap \alpha \neq \emptyset, ;$$

absurd because  $b \parallel \alpha (b \parallel b')$ .

Solution to [Problem 85](#).

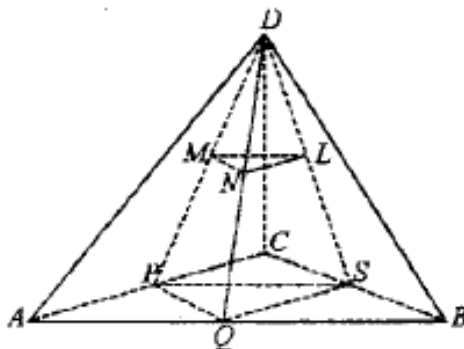

$M$  is the centroid in  $\Delta ACD \Rightarrow$

$$\Rightarrow \frac{|MD|}{|MP|} = 2 \quad (1)$$

$N$  is the centroid in  $\Delta ABD \Rightarrow$

$$\Rightarrow \frac{|ND|}{|NQ|} = 2 \quad (2)$$

$L$  is the centroid in  $\Delta BCD \Rightarrow$

$$\Rightarrow \frac{|LD|}{|LS|} = 2 \quad (3)$$

From 1 and 2,

and from 2 and 3

$$\left. \begin{array}{l} \Rightarrow MN \parallel PQ \\ \Rightarrow ML \parallel QS \end{array} \right\} \Rightarrow (LMN) \parallel (PQS) = (ABC) \Rightarrow (LMN) \parallel (ABC).$$

$$\frac{\sigma[SPQ]}{\sigma[ABC]} = \frac{s}{4s} = \frac{1}{4}$$

because:

$$\sigma[AQP] = \sigma[PQS] = \sigma[QBS] = \sigma[PSC] = s$$

So

$$\frac{\sigma[ABC]}{\sigma[LMN]} = \frac{4}{1} \cdot \frac{9}{4} = 9.$$

Solution to [Problem 86](#).

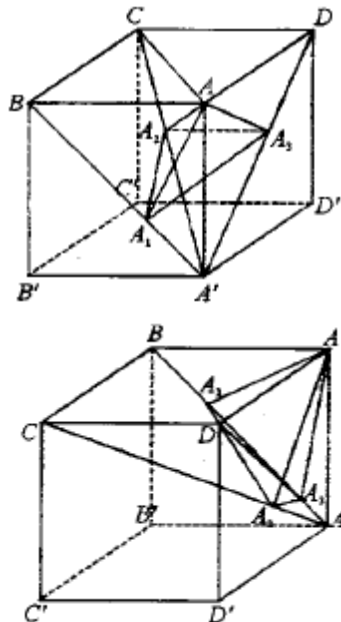

$BD \perp (AA'C)$  from the hypothesis  $ABCD A'B'C'D'$  cube (1).

$$\left. \begin{array}{l} A_1 \text{ midpoint of segment } |BA'| \\ (ABA') \text{ isosceles and } AA_1 \perp BA' \\ A_3 \text{ midpoint of } |A'D| \end{array} \right\} |A_1A_3| \text{ mid-side in } \Delta A'BD \Rightarrow A_1A_3 \parallel BD \quad (2)$$

From (1) and (2)  $\Rightarrow A_1A_3 \parallel (AA'C) \Rightarrow A'C \perp A_1A_3$  (3)

From  $\triangle ACA'$ :

$$\|AA_2\| = \frac{\|AC\| \cdot \|AA'\|}{\|A'C\|} = \frac{a\sqrt{2} \cdot a}{a\sqrt{3}} = \frac{a\sqrt{6}}{3}.$$

From  $\triangle ABA'$ :

$$\|AA_3\| = \frac{a^2}{a\sqrt{2}} = \frac{a^2\sqrt{2}}{2};$$

Similarly

$$\|AA_3\| = \frac{a\sqrt{2}}{2}.$$

In  $\triangle ACA'$ :

$$\|AA'\|^2 = \|A'A_2\| \cdot \|A'C\| \Rightarrow a^2 = \|A'A_2\| \cdot a\sqrt{3} \Rightarrow \|A'A_2\| = \frac{a\sqrt{3}}{3}$$

and

$$\|A'A_1\| = \left\| \frac{a\sqrt{2}}{2} \right\|.$$

$$(\cos \alpha = \frac{a\sqrt{2}}{a\sqrt{3}} = \frac{\sqrt{2}}{\sqrt{3}} (\triangle A'BC))$$

$$\|A_1A_2\|^2 = \frac{a^2}{2} + \frac{a^2}{3} - 2 \frac{a^2}{\sqrt{6}} \cdot \frac{\sqrt{2}}{\sqrt{3}} = \frac{5a^2}{6} - \frac{2a^2}{3} = \frac{a^2}{6}.$$

$$\|AA_2\|^2 = \|a_1A_2\|^2 + \|AA_1\|^2 \Rightarrow \frac{a^2 6}{9} = \frac{a^2}{6} + \frac{a^2}{2} \Rightarrow \frac{2a^2}{3} = \frac{2a^2}{3} \xrightarrow{pct.(B)} AA_1 \perp A_1A_2 \text{ pct.}(B)$$

$$AA_3 \perp A_2A_3.$$

$A_1A_2A'$  right with  $m(A'A_2A_1) = 90$  because

$$\begin{aligned} \|A'A_1\|^2 &= \|A'A_2\|^2 + \|A_1A_2\|^2 \Leftrightarrow \frac{a^2}{2} = \\ &= \frac{a^2}{3} + \frac{a^2}{6} \Leftrightarrow \frac{a^2}{2} = \frac{3a^2}{6} (a) \Rightarrow A'C \perp A_1A_2 \quad (4) \end{aligned}$$

From (4) and (3)  $\Rightarrow A'C \perp (A_1A_2A_3)$ .

As  $\left. \begin{array}{l} A'C \perp (A_1A_2A_3) \\ A'C \perp A_2A \text{ (by construction)} \end{array} \right\} \Rightarrow A_1A_2A_3A \text{ coplanar} \Rightarrow A_1A_2A_3A \text{ quadrilateral with opposite angles } A_1 \text{ and } A_3 \text{ right} \Rightarrow A_1A_2A_3A \text{ inscribable quadrilateral.}$

Solution to [Problem 87](#).

The conclusion is true only if  $\|BD\| = \|AC\|$  that is  $b = c$ .

$$\|NC\| = \frac{\sqrt{a^2 + b^2 + c^2}}{2}; \|MC\| = \sqrt{b^2 + \frac{a^2}{4}}; \|MN\| = \frac{b^2 + c^2}{3}$$

$MN \perp DC$  if

$$\begin{aligned} \|MC\|^2 &= \|MN\|^2 + \|NC\|^2 \Leftrightarrow \frac{a^2 + b^2 + c^2}{4} + \frac{b^2 + c^2}{4} = b^2 + \frac{a^2}{4} \Rightarrow a^2 + 2b^2 + \\ &+ 2c^2 = 4b^2 + a^2 \Rightarrow c^2 = b^2 \Rightarrow b = c. \end{aligned}$$

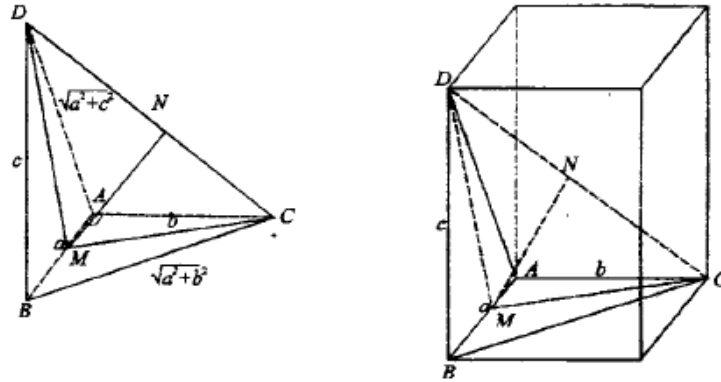

Solution to [Problem 88](#).

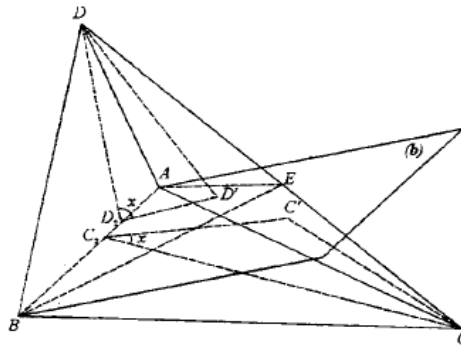

bisector plane

$$\left. \begin{array}{l} DD' \perp (ABE) = b \\ DD_1 \perp AB \\ CC' \perp (ABE) \\ CC_1 \perp AB \end{array} \right\} \Rightarrow \left. \begin{array}{l} D'D_1 \perp AB \\ C'C_1 \perp AB \end{array} \right\} \Rightarrow D_1D' \parallel C_1C''.$$

$$m(\widehat{DD_1D'}) = m(\widehat{C'C_1C}) = x$$

(*b* bisector half-plane)

In triangle  $DD_1D'$ :

$$\left. \begin{array}{l} \sin x = \frac{\|DD'\|}{\|DD_1\|} \\ \sin x = \frac{\|CC'\|}{\|CC_1\|} \end{array} \right\} \Rightarrow \frac{\|DD'\|}{\|DD_1\|} = \frac{\|CC'\|}{\|CC_1\|} \Rightarrow \frac{\|DD'\|}{\|CC'\|} = \frac{\|DD_1\|}{\|CC_1\|} \Rightarrow$$

$$\Rightarrow \frac{\|DD'\|}{\|CC'\|} = \frac{\sigma[ABD]}{\sigma[ABC]} \quad (1)$$

$$\left. \begin{array}{l} v[ABED] = \frac{\sigma[ABE] \cdot \|DD'\|}{3} \\ v[ABEC] = \frac{\sigma[ABE] \cdot \|CC'\|}{3} \end{array} \right\} \Rightarrow \frac{\|DD'\|}{\|CC'\|} = \frac{v[ABED]}{v[ABEC]} \quad (2)$$

But

$$\left. \begin{aligned} v[ABED] &= \frac{\sigma[DEC] \cdot d(A, (DEC))}{3} \\ v[ABEC] &= \frac{\sigma[BEC] \cdot d(A, (DBC))}{3} \end{aligned} \right\} \Rightarrow \frac{v[ABED]}{v[ABEC]} = \frac{\sigma[BDE]}{\sigma[BEC]} = \frac{\|DE\| \cdot d(B, DC)}{\|EC\| \cdot d(B, DC)} =$$

$$= \frac{\|DE\|}{\|EC\|} \Rightarrow \frac{v[ABED]}{v[ABEC]} = \frac{\|DE\|}{\|EC\|} \quad (3)$$

From 1, 2, 3  $\Rightarrow \frac{\sigma[ABD]}{\sigma[ABC]} = \frac{\|DE\|}{\|EC\|}$  q.e.d.

Solution to [Problem 89](#).

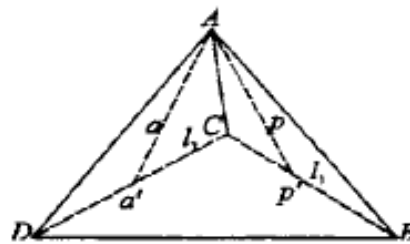

Because the tetrahedron is regular  $AB = \dots =$

$$\|BD\| = l$$

$$\|CP'\| = l_1$$

$$\|CQ'\| = l_2$$

$$\cos \widehat{QAP} = \cos(\widehat{Q'AP'}) = \frac{\|AQ'\|^2 + \|AP'\|^2 - \|Q'P'\|^2}{2\|AQ'\| \cdot \|AP'\|} \geq$$

we increase the denominator

$$\geq \frac{l^2 + l_2^2 - ll_2 + l^2 - ll_1 - l_1^2 - l_2^2 + l_1l_2}{2l^2} = \frac{l^2 + l^2 - ll_1 - ll_2 + l_1l_2}{2l^2} = \frac{1}{2} + \frac{(l-l_1)(l-l_2)}{2l^2} \geq \frac{1}{2} \Rightarrow$$

$$\Rightarrow \cos \widehat{QAP} \geq \frac{1}{2} \Rightarrow m(\widehat{QAP}) \leq 60^\circ.$$

If one of the points  $P$  or  $Q$  is on face  $CBD$  the problem is explicit.

Solution to [Problem 90](#).

We consider tetrahedron  $Oxyz$ , and prove that the sum of the measures of the dihedral angles of this trihedron is bigger than  $360^\circ$ . Indeed: let  $100'$  be the internal bisector of trihedron  $Oxyz$  ( $1000'$  the intersection of the bisector planes of the 3 dihedral angles) of the trihedron in  $A, B, C$ .

The size of each dihedron with edges  $ox, oy, oz$  is bigger than the size of the corresponding angles of  $ABC$ , the sum of the measures of the dihedral angles of trihedron  $Oxyz$  is bigger than  $180^\circ$ .

Let  $(a, b)$  be a plane  $\perp$  to  $oz$  at  $C$ ;  $a \perp oz, b \perp oz$ , but  $|CA$  and  $|CB$  are on the same half-space in relation to  $(ab) \Rightarrow m(\hat{C}) < m(\widehat{ab})$ .

In tetrahedron  $ABCD$ , let  $\alpha_1, \alpha_2, \alpha_3, \alpha_4, \alpha_5$  and  $\alpha_6$  be the 6 dihedral angles formed by the faces of the tetrahedron.

$$\left. \begin{aligned} m(\alpha_1 + \alpha_2 + \alpha_3) &> 180 \\ m(\alpha_1) + m(\alpha_3) + m(\alpha_6) &> 180 \\ m(\alpha_2) + m(\alpha_4) + m(\alpha_5) &> 180 \\ m(\alpha_4) + m(\alpha_5) + m(\alpha_6) &> 180 \end{aligned} \right\}$$

according to the inequality previously established.

$$2(m(\alpha_1) + m(\alpha_2) + \dots + m(\alpha_6)) > 4 \cdot 180 \Rightarrow m(\alpha_1) + \dots + m(\alpha_6) > 360^\circ.$$

Solution to [Problem 91](#).

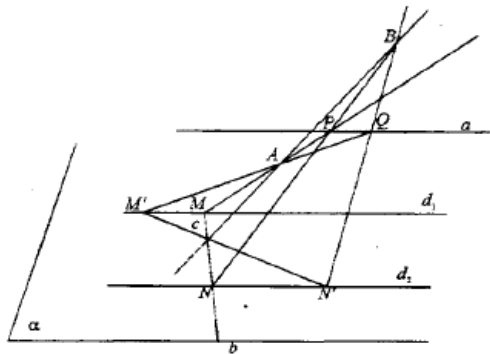

We mark with  $a$  the intersection of planes  $(A, d_1)$  and  $(B, d_2)$ . So

$$(A, d_1) \cap (B, d_2) = a.$$

Let  $b$  be a variable line that passes through  $C$  and contained in  $\alpha$ , which cuts  $d_1$  and  $d_2$  at  $M$  respectively  $N$ . We have:  $MA \subset (A, d_1), MA \cap NB = P(MA \text{ and } NB \text{ intersect because they are contained in the plane determined by } (AM, b))$ .

Thus  $P \in (A, d_1)$  and  $P \in (B, d_2), \Rightarrow P \in a$ , so  $P$  describes line  $a$  the intersection of planes  $(A, d_1)$  and  $(B, d_2)$ .

*Vice-versa:* let  $Q \in a$ .

$$\text{In the plane } (A, d_1): QA \cap d_1 = M'$$

$$\text{In the plane } (B, d_2): QB \cap d_2 = N'$$

Lines  $N'M'$  and  $AB$  are coplanar (both are on plane  $(Q, A, B)$ ). But because  $N'M' \subset \alpha$  and  $AB$  has only point  $C$  in common with  $\alpha \Rightarrow M'N' \cap AB = C$ .

So  $M'N'$  passes through  $C$ . If planes  $(A, d_1)$  and  $(B, d_2)$  are parallel, the locus is the empty set.

Solution to [Problem 92](#).

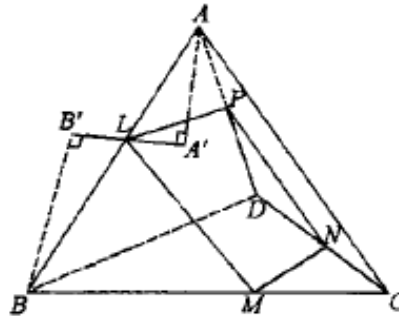

Remember the theorem: If a plane  $\gamma$  intersects two planes  $\alpha$  and  $\beta$  such that  $\sigma \parallel \alpha \Rightarrow (\gamma \cap \alpha) \parallel (\gamma \cap \beta)$ . If plane  $(LMNP) \parallel BD$  we have:

$$\left. \begin{aligned} LP \parallel MN \parallel BD &\Rightarrow \frac{\|LA\|}{\|AP\|} = \frac{\|LB\|}{\|PD\|} \Rightarrow \|LA\| \cdot \|PD\| = \|AP\| \cdot \|LB\| \\ MN \parallel BD &\Rightarrow \frac{\|NC\|}{\|MC\|} = \frac{\|ND\|}{\|MB\|} \Rightarrow \|BM\| \cdot \|NC\| = \|ND\| \cdot \|MC\| \end{aligned} \right\} \Rightarrow$$

$$\Rightarrow \|AL\| \cdot \|BM\| \cdot \|CN\| \cdot \|DP\| = \|BL\| \cdot \|CM\| \cdot \|DN\| \cdot \|AP\|.$$

If  $(LMNP) \parallel AC$  we have:

$$LM \parallel PN \parallel AC \Rightarrow \frac{\|PD\|}{\|DN\|} \text{ și } \frac{\|AL\|}{\|MC\|} = \frac{\|LB\|}{\|BM\|} \Rightarrow$$

$$\Rightarrow \begin{cases} \|CN\| \cdot \|DP\| = \|DN\| \cdot \|AP\| \\ \|AL\| \cdot \|BM\| = \|BL\| \cdot \|CM\| \end{cases}$$

$\Rightarrow$  relation  $a$ .

*Solution:*

Let  $A', B', C', D'$  the projections of points  $A, B, C, D$  onto plane  $(MNPL)$ .

For ex. points  $B', L, A'$  are collinear on plane  $(LPMN)$  because they are on the projection of line  $AB$  onto this plane.

$$\triangle ALA' \sim \triangle BLB'(U, U) \Rightarrow \frac{\|AL\|}{\|LB\|} = \frac{\|AA'\|}{\|BB'\|}.$$

Similarly we obtain:

$$\frac{\|PD\|}{\|AP\|} = \frac{\|DD'\|}{\|AA'\|}; \frac{\|CN\|}{\|ND\|} = \frac{\|CC'\|}{\|DD'\|}; \frac{\|BM\|}{\|MC\|} = \frac{\|BB'\|}{\|CC'\|}.$$

By multiplying the 4 relations,

$$\frac{\|AL\| \cdot \|PD\| \cdot \|CN\| \cdot \|BM\|}{\|LB\| \cdot \|AP\| \cdot \|DN\| \cdot \|MC\|} = 1 \Rightarrow$$

$\Rightarrow$  relation (a) from d.

Solution to [Problem 93](#).

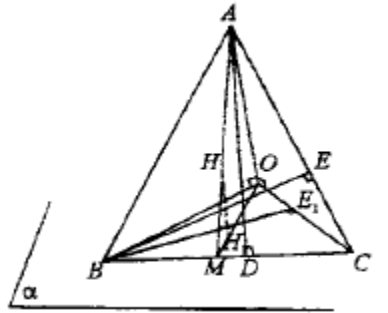

$M$  – Midpoint of  $|BC|$ .

Solution to [Problem 94](#).

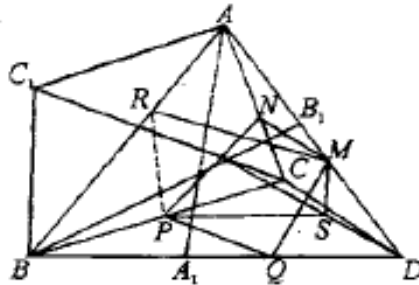

(1)  $AB \perp CD$  (hypothesis)

$$DH \perp (ABC) \Rightarrow DH \perp Ab \Rightarrow AB \perp DH \quad (2)$$

From 1 and 2

$$\Rightarrow AB \perp (CDH) \Rightarrow AB \perp CH \Rightarrow CH$$

height in  $\Delta ABC$   $a$

$$AC \perp BD \quad (3)$$

$$DH \perp (ABC) \Rightarrow DH \perp AC \Rightarrow AC \perp DH \quad (4)$$

From 3 and 4  $AC \perp (BDH) \Rightarrow AC \perp BH \Rightarrow BH$  height in  $\Delta ABC$   $b$

From  $a$  and  $b \Rightarrow H$  orthocenter  $\Delta ABC$ . Let  $C_1$  be the diametrical opposite point to  $C$  in circle  $C(ABC)CC_1$  diameter  $m(\widehat{C_1BC}) = 90^\circ$  but  $AH \perp BC \Rightarrow AH \parallel BC_1$ . Similarly  $BH \parallel C_1A$ , so  $AHBC_1$  parallelogram, we have:



$$\|AH\|^2 + \|BC\|^2 = \|BC_1\|^2 + \|BC\|^2 = \|CC_1\|^2 = (2R)^2$$

similarly

$$\|BH\|^2 + \|AC\|^2 = (2R)^2 \quad (\|BH\| = \|AB_1\|) B_1$$

diametrical opposite to B

$$\|CH\|^2 + \|AB\|^2 = (2R)^2 \quad (\|CH\| = \|BA_1\|)$$

but

$$DH \perp (ABC) \Rightarrow \left. \begin{aligned} \|AH\|^2 &= \|AD\|^2 - \|DH\|^2 \\ \|BH\|^2 &= \|BD\|^2 - \|DH\|^2 \\ \|CH\|^2 &= \|DC\|^2 - \|DH\|^2 \end{aligned} \right\}$$

by substituting above, we have:

$$\|AD\|^2 + \|BC\|^2 = (2R)^2 + \|DH\|^2$$

$$\|BD\|^2 + \|AC\|^2 = (2R)^2 + \|DH\|^2$$

$$\|DC\|^2 + \|AB\|^2 = (2R)^2 + \|DH\|^2$$

Let  $N, M, Q, P, S, R$  midpoints of the edges of the quadrilateral  $NMPQ$  because:

$NM \parallel CD \parallel PQ$  (median lines),  $QM \parallel AB \parallel PN$  (median lines), but  $CD \perp AB \Rightarrow MNQP$  rectangle  $|NQ| \cap |PM| = \{0\}$ .

Similarly  $MSPR$  rectangle with  $|MP|$  common diagonal with a, the first rectangle, so the 6 points are equally distant from "O" the midpoint of diagonals in the two rectangles  $\Rightarrow$  the 6 points are on a sphere.

Solution to [Problem 95](#).

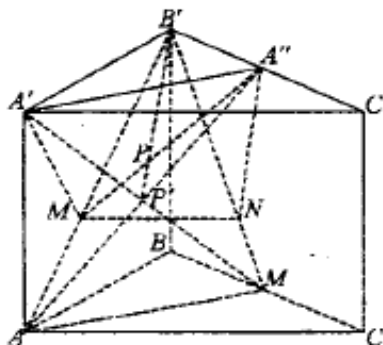

$M$  arbitrary point on  $|AB'|$

$$N = pr_{(BCC')}M$$

$A''$  midpoint of segment  $[B'C']$

When  $M = B'$ , point  $P$  is in the position  $B'$ .

When  $M = A$ , point  $P$  is in the position  $\{P_1\} = [A'A_1] \cap [AA'']$

( $A'A''A_1A$  rectangle, so  $P_1$  is the intersection of the diagonals of the rectangle)

[The locus is  $[B'P_1]$ ].

Let  $M$  be arbitrary point  $M \in [AB']$ .

$$N = pr_{(BCC')}M \in [A_1B']$$

because:

$$(B'AA_1) \perp (B'CC')$$

By the way it was constructed

$$AA_1 \perp BC, AA_1 \perp CC' \Rightarrow AA_1 \perp (B'C'C) \Rightarrow$$

$\Rightarrow (\forall)$  plane that contains  $AA_1$  is perpendicular to  $(B'CC')$ , particularly to  $(B'AA_1) \perp (B'C'C)$ .

$$(1) [B'P_1] \subset (B'A''A)$$

because  $B', P \in (B'AA'')$

$$(2) [B'P_1] \subset (A'B'A_1)$$

from this reason  $B', P_1 \in (A'B'A_1)$ .

From 1 and 2

$$\Rightarrow B'P_1 = (A'B'A_1) \cap (B'A''A)$$

Let

$$\left. \begin{array}{l} \{P\} = [MA''] \cap [A'N] \\ [MA''] \subset (B'A''A) \text{ și } \\ [A'N] \subset (A'B'A_1) \end{array} \right\} \Rightarrow P \in (B'A''A) \cap (A'B'A_1) \Rightarrow P \in [B'P_1] \quad N = pr_{(B'C'O)}M$$

So  $(\forall) M \in [B'A]$

and we have

$$[MA''] \cap [A'N] \in [B'P_1].$$

*Vice-versa.* Let  $P$  arbitrary point,  $P \in [B'P_1]$  and

In plane

$$(B'A''A) : \{M\} = [B'A] \cap [A''P]$$

In plane

$$(B'A'A_1) : \{N\} = [B'A_1] \cap [A'P]$$

Indeed:  $A'A'' \parallel (B'AA_1)$  thus any plane which passes through  $A'A''$  will intersect

$(B'AA_1)$  after a parallel line to  $A'A''$ . Deci  $MN \parallel A'A''$  or  $MN \parallel AA_1$  as  $M \in (B'AA_1) \Rightarrow$

$MN \perp (B'CC')$ .

We've proved

$$(\forall) M \in [B'A]$$

and

$$N = \text{pr}_{(B'CC')}M$$

we have

$$\{P\} = |MA''| \cap |A'N|$$

describes  $|B'P_1|$  and vice-versa,

$$(\forall)P \in [B'P_1]$$

there is  $M|B'A|$  and  $N|B'A_1|$  such that

$$N = \text{pr}_{(B'C'C')}M$$

and  $P$  is the intersection of the diagonals of the quadrilateral  $A'NMA''$ .

Solution to [Problem 96](#).

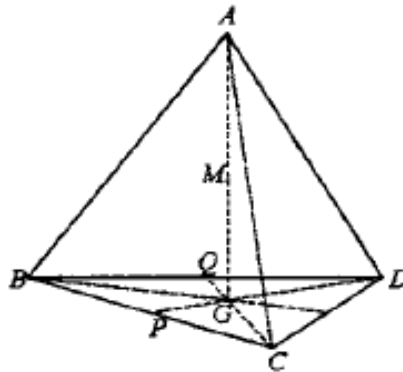

$$\sigma[CDG] = \sigma[BDG] = \sigma[BCG] = \frac{\sigma[BCD]}{3}$$

known result

$$\begin{cases} v[MGCD] = \frac{\sigma[GCD]d(M, (BCD))}{3} \\ v[MGDB] = \frac{\sigma[BDG]d(M, (BCD))}{3} \\ v[MGBC] = \frac{\sigma[BCG]d(M, (BCD))}{3} \end{cases}$$

From 1 and 3

$$\Rightarrow v[MGCD] = v[MGDB] = v[MBC].$$

Solution to [Problem 97](#).

From the hypothesis:

$$OA \perp OB \perp OC \perp OA$$

We assume the problem is solved.

Let  $M$  be the orthocenter of triangle  $ABC$ .

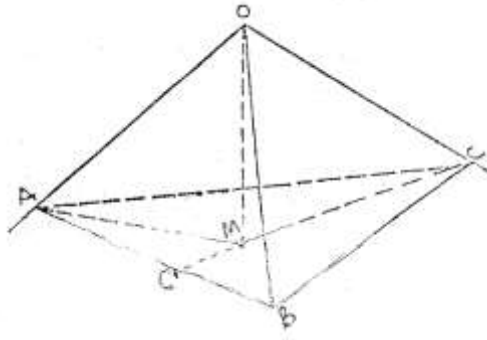

$$\text{But } CC' \perp AB \Rightarrow \left. \begin{array}{l} AB \perp (OCC') \\ MO \perp (COC') \end{array} \right\} \Rightarrow AB \perp OM \Rightarrow MO \perp AB \quad (1)$$

$$AO \perp (COB) \Rightarrow AO \perp BC, \text{ but } AA' \perp BC \Rightarrow \left. \begin{array}{l} BC \perp (AOA') \\ MO \subset (AOA') \end{array} \right\} \Rightarrow BC \perp MO \Rightarrow MO \perp BC \quad (2)$$

From (1) and (2)  $\Rightarrow MO \perp (ABC)$

So the plane  $(ABC)$  that needs to be drawn must be perpendicular to  $OM$  at  $M$ .

Solution to [Problem 98](#).

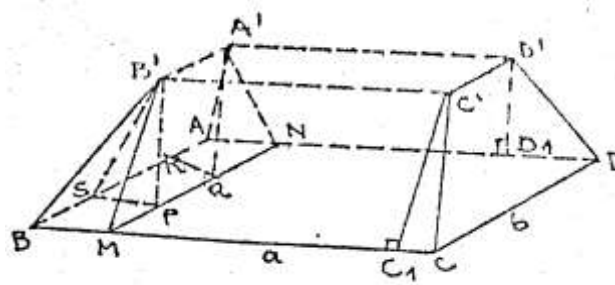

$$A'N \perp AD, B'M \perp BC$$

$$\|BM\| = \frac{a-a'}{2}, \|PM\| = \frac{b-b'}{2}$$

$$v[BMPSB'] = \frac{a-a'}{2} \cdot \frac{b-b'}{2} \cdot \frac{h}{3}$$

$$v[SPWRA'B'] = \frac{\sigma[SPB'] \cdot \|B'A'\|}{3} = \frac{a-a'}{2} \cdot \frac{h}{2} \cdot b'$$

$$v[B'A'NMC'D'D_1C_1] = \frac{(b+b')h}{2} \cdot a'$$

$$v[ABA'B'CDC'D'] = 2 \left[ 2 \cdot \frac{a-a'}{2} \cdot \frac{b-b'}{2} \cdot \frac{h}{3} + \frac{a-a'}{2} \cdot \frac{h}{2} \cdot b' \right] + \left( \frac{(b+b')h}{2} \right) \cdot a' =$$

$$\frac{h}{6} (2ab - 2ab' - 2a'b' + 3ab' - 3a'b' + 3a'b + 3a'b') = \frac{h}{6} [ab + a'b' + (a+a')(b+b')].$$

Solution to [Problem 99](#).

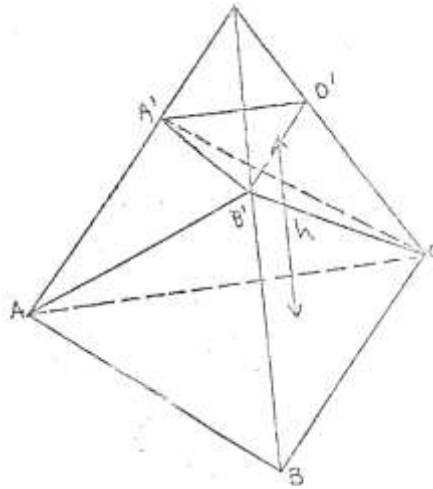

$$v[OABB'] = \frac{B \cdot h}{2}$$

$$v[OA'B'A] = v[ABOO'A'B'] - v[ABB'O] - v[A'B'O'O] = \frac{h}{3}(B + b + \sqrt{Bb}) - \frac{Bh}{3} - \frac{bh}{3} = \frac{h}{3}\sqrt{bB}.$$

So:

$$\frac{v[OA'B'A]}{v[DABB']} = \frac{\frac{h}{3}\sqrt{Bb} \cdot \sqrt{Bb}}{\frac{Bh}{3} \cdot B} = \frac{\sqrt{b}}{\sqrt{B}} \Rightarrow v[OA'B'A] = \frac{\sqrt{b}}{\sqrt{B}} \cdot v[OABB']$$

For the relation above, determine the formula of the volume of the pyramid frustum.

Solution to [Problem 100](#).

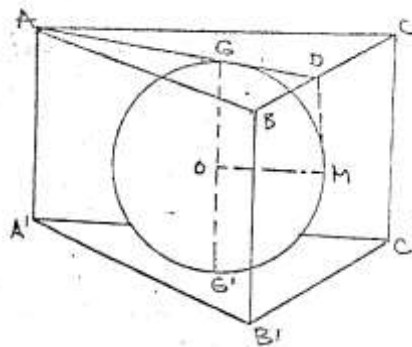

$$d(GG') = h = 2R$$

$$\text{Let } l = \|AC\| \Rightarrow \|AD\| = \frac{l\sqrt{3}}{2} \Rightarrow \|GD\| = \frac{l\sqrt{3}}{6}$$

$$\text{Figure } GDMO \text{ rectangle} \Rightarrow \|GD\| = \|OM\| \Rightarrow \frac{l\sqrt{3}}{6} = R = 2\sqrt{3}R$$

So, the lateral area is  $S_l = 3 \cdot 2\sqrt{3}R \cdot R = 12\sqrt{3}R^2$ .

$$v[ABCA'B'C'] = \sigma[ABC] \cdot 2R = 2\sqrt{3}R \cdot \frac{2\sqrt{3}R\sqrt{3}}{4} \cdot 2R = 6\sqrt{3}R^2.$$

The total area:

$$S_t = S_l + 2\sigma[ABC] = 12\sqrt{3}R^2 + 2 \cdot 3R\sqrt{3}R^2 = 18\sqrt{3}R^2$$

Solution to [Problem 101](#).

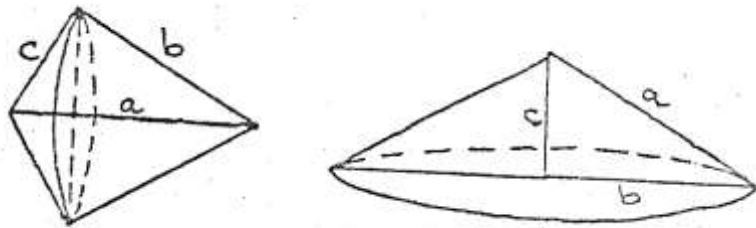

Let  $V_1$  and  $S_1$  be the volume, respectively the area obtained revolving around  $a$ .

$V_2$  and  $S_2$  be the volume, respectively the area obtained after revolving around  $b$ .

$V_3$  and  $S_3$  be the volume, respectively the area obtained after revolving around  $c$ .

So:

$$V_1 = \frac{\pi \cdot i^2 (\|CD\| + \|DB\|)}{3} = \frac{\pi \cdot i^2 \cdot a}{3}$$

$$S_1 = \pi \cdot i \cdot c + \pi \cdot i \cdot b = \pi \cdot i \cdot (b + c)$$

$$V_2 = \frac{\pi c^2 b}{3} = \frac{\pi c^2 b^2}{3b} = \frac{\pi b^2 c^2 a}{3a^2}$$

$$S_2 = \pi \cdot c \cdot a$$

$$V_3 = \frac{\pi b^2 c}{3} = \frac{\pi b^2 c^2}{3c} = \frac{\pi b^2 c^2}{3a}$$

$$S_3 = \pi \cdot b \cdot a$$

Therefore:

$$\frac{1}{V_1^2} = \frac{1}{V_2^2} + \frac{1}{V_3^2} \Leftrightarrow \frac{9a^2}{(\pi b^2 c^2)^2} = \frac{9c^2}{(\pi b^2 c^2)^2} + \frac{9c^2}{(\pi b^2 c^2)^2}$$

$$\frac{S_2}{S_3} + \frac{S_3}{S_2} = \frac{S_2 + S_3}{S_1} \Leftrightarrow \frac{c}{b} + \frac{b}{c} = \frac{\pi a(b+c)}{\pi i(b+c)} \Leftrightarrow \frac{c^2 + b^2}{b \cdot c} = \frac{a}{i}$$

But  $i \cdot a = b \cdot c \Rightarrow \frac{c^2 + b^2}{bc} = \frac{a^2}{bc}$ ,  $\|AD\| = i$ .

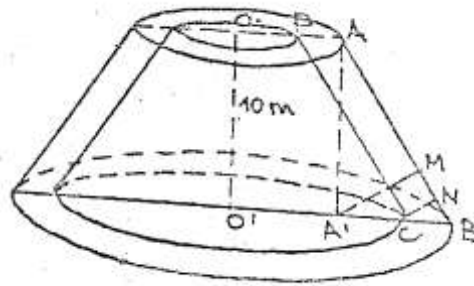
Solution to [Problem 102.](#)

$$r = \|OA\| = 25 \text{ cm}$$

$$R = \|O'B\| = 50 \text{ cm}$$

$$2\pi r = 1,57 \Rightarrow r = 0,25 \text{ m}$$

$$2\pi R = 3,14 \Rightarrow R = 0,50 \text{ m}$$

$$\|CN\| = 18 \text{ cm} = 0,18 \text{ m}$$

$$\|A'B\| = 25 \text{ cm}$$

$$\|AB\| = \sqrt{100 + 0,0625} = 10,003125$$

$$\|A'M\| = \frac{\|AA'\| \cdot \|A'B\|}{\|AB\|} = \frac{10 \cdot 0,25}{10,003125} \approx 0,25$$

$$\frac{\|CN\|}{\|A'M\|} = \frac{\|CB\|}{\|BA'\|} \Rightarrow \frac{0,18}{0,25} = \frac{\|CB\|}{0,25} \Rightarrow \|CB\| = 0,18$$

$$\|O'C\| = R' = 0,50 - 0,18 = 0,32$$

$$\|OP\| = r' = 0,25 - 0,18 = 0,07$$

$$V = \frac{\pi 1}{3} (R^2 + r^2 + Rr)$$

$$V = \frac{\pi 10}{3} (0,50^2 + 0,25^2 + 0,50 \cdot 0,25 - 0,32^2 - 0,07^2 - 0,32 \cdot 0,07)$$

$$= \frac{\pi 10}{3} (0,4375 - 0,1297) = 1,026\pi \text{ m}^3$$

 Solution to [Problem 103.](#)

$$\|VP\| = \frac{a}{2 \sin \frac{\alpha}{2}} \cos \frac{\alpha}{2}$$

$$\text{In } \Delta VAP: \|VA\| = \frac{A}{2 \sin \frac{\alpha}{2}}$$

$$\text{In } \Delta VAO': \|VO'\|^2 = \frac{a^2}{4 \sin^2 \frac{\alpha}{2}} - \frac{a^2}{2}.$$

$$\|VO'\| = \frac{a\sqrt{\cos \alpha}}{2 \sin \frac{\alpha}{2}}$$

$$\text{In } \Delta VOO': \|OO'\| = \frac{a\sqrt{\cos \alpha}}{2 \sin \frac{\alpha}{2}} - R.$$

$$R^2 = \frac{a^2}{2} + \left( \frac{a\sqrt{\cos \alpha}}{2 \sin \frac{\alpha}{2}} - R \right)^2 \Rightarrow \frac{a^2}{2} + \frac{a^2 \cos \alpha}{4 \sin^2 \frac{\alpha}{2}} - \frac{2aR\sqrt{\cos \alpha}}{2 \sin \frac{\alpha}{2}} \Rightarrow a = \frac{4R\sqrt{\cos \alpha} \sin^2 \frac{\alpha}{2}}{\sin \frac{\alpha}{2} (2 \cos^2 \frac{\alpha}{2} + \cos \alpha)}$$

$$\Rightarrow a = 4R\sqrt{\cos \alpha} \cdot \sin \frac{\alpha}{2}$$

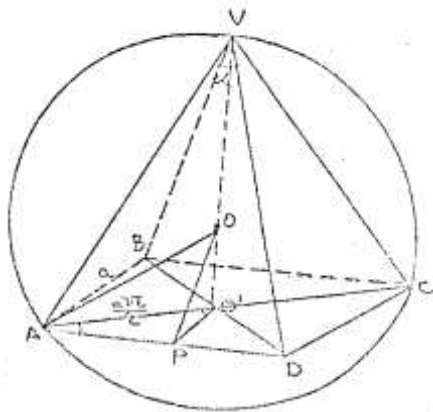

$$A_t = 4 \frac{a^2 \cos \frac{\alpha}{2}}{2 \cdot 2 \sin \frac{\alpha}{2}} = \frac{a^2 \cos \frac{\alpha}{2}}{\sin \frac{\alpha}{2}} = 16R^2 \cos \alpha \sin^2 \frac{\alpha}{2} \cdot \frac{\cos \frac{\alpha}{2}}{\sin \frac{\alpha}{2}} = 8R^2 \cos \alpha \sin \alpha = 4R^2 \sin 2\alpha$$

$$A_t = A_l + a^2 = 4R^2 \sin 2\alpha + 16R^2 \cos \alpha \sin^2 \frac{\alpha}{2}$$

$$\|VO'\| = R \Rightarrow R = \frac{a\sqrt{\cos \alpha}}{2 \sin \frac{\alpha}{2}} \Rightarrow R = 4R\sqrt{\cos \alpha} \sin \frac{\alpha}{2} \cdot \frac{\sqrt{\cos \alpha}}{2 \sin \frac{\alpha}{2}} \Rightarrow 2 \cos \alpha = 1 \Rightarrow \alpha = 60^\circ.$$



## Various Problems

104. Determine the set of points in the plane, with affine coordinates  $z$  that satisfy:

- a.  $|z| = 1$ ;
- b.  $\pi < \arg z \leq \frac{3\pi}{2}; z \neq 0$ ;
- c.  $\arg z > \frac{4\pi}{3}, z \neq 0$ ;
- d.  $|z + i| \leq 2$ .

[Solution to Problem 104](#)

105. Prove that the  $n$  roots of the unit are equal to the power of the particular root  $\varepsilon_1$ .

[Solution to Problem 105](#)

106. Knowing that complex number  $z$  verifies the equation  $z^n = n$ , show that numbers  $2$ ,  $-iz$  and  $iz$  verify this equation.

*Application:* Find  $(1 - 2i)^4$  and deduct the roots of order 4 of the number  $-7 + 24i$ .

[Solution to Problem 106](#)

107. Show that if natural numbers  $m$  and  $n$  are coprime, then the equations  $z^m - 1 = 0$  and  $z^n - 1 = 0$  have a single common root.

[Solution to Problem 107](#)

108. Solve the following binomial equation:  $(2 - 3i)z^6 + 1 + 5i = 0$ .

[Solution to Problem 108](#)

109. Solve the equations:

$$a) z^6 - 9z^3 + 8 = 0$$

$$z^3 = y$$

$$b) z^8 - 2z^4 + 2 = 0$$

$$z^4 = y$$

$$c) z^4 + 6(1+i)z^2 + 5 + 6i = 0$$

$$z^2 = y$$

[Solution to Problem 109](#)

110. Solve the equation  $\bar{z} = z^{n-1}$ ,  $n \in \mathbb{N}$ , where  $\bar{z}$  the conjugate of  $z$ .

[Solution to Problem 110](#)

111. The midpoints of the sides of a quadrilateral are the vertices of a parallelogram.

[Solution to Problem 111](#)

112. Let  $M_1M_2M_3M_4$  and  $N_1N_2N_3N_4$  two parallelograms and  $P_i$  the midpoints of segments  $[M_iN_i]$ ,  $i \in \{1, 2, 3, 4\}$ . Show that  $P_1P_2P_3P_4$  is a parallelogram or a degenerate parallelogram.

[Solution to Problem 112](#)

113. Let the function  $f: \mathbb{C} \rightarrow \mathbb{C}$ ,  $f(z) = az + b$ ; ( $a, b, c \in \mathbb{C}$ ,  $a \neq 0$ ). If  $M_1$  and  $M_2$  are of affixes  $z_1$  and  $z_2$ , and  $M'_1$  and  $M'_2$  are of affixes  $f(z_1)$ ,  $f(z_2)$ , show that  $\|M'_1M'_2\| = |a| \cdot \|M_1M_2\|$ . We have  $\|M'_1M'_2\| = \|M_1M_2\| \Leftrightarrow |a| = 1$ .

[Solution to Problem 113](#)

114. Prove that the function  $z \rightarrow \bar{z}$ ,  $z \in \mathbb{C}$  defines an isometry.

[Solution to Problem 114](#)

115. Let  $M_1M_2$  be of affixes  $z_1, z_2 \neq 0$  and  $z_2 = \alpha z_1$ . Show that rays  $|OM_1|$ ,  $|OM_2$  coincide (respectively are opposed)  $\Leftrightarrow \alpha > 0$  (respectively  $\alpha < 0$ ).

[Solution to Problem 115](#)

116. Consider the points  $M_1M_2M_3$  of affixes  $z_1z_2z_3$  and  $M_1 \neq M_2$ . Show that:

a.  $M_3 \in |M_1M_2 \Leftrightarrow \frac{z_3-z_1}{z_2-z_1} > 0;$

b.  $M_3 \in M_1M_2 \Leftrightarrow \frac{z_3-z_1}{z_2-z_1} \in \mathbb{R}.$

[Solution to Problem 116](#)

117. Prove Pompeiu's theorem. If the point  $M$  from the plane of the equilateral triangle  $M_1M_2M_3 \notin$  the circumscribed circle  $\Delta M_1M_2M_3 \Rightarrow$  there exists a triangle having sides of length  $\|MM_1\|, \|MM_2\|, \|MM_3\|.$

[Solution to Problem 117](#)

## Solutions

Solution to [Problem 104](#).

- a.  $\left. \begin{array}{l} |z| = 1 \\ |z| = \sqrt{x^2 + y^2} \end{array} \right\} \Rightarrow x^2 + y^2 = 1$ , so the desired set is the circle  $C_{(0,1)}$ .
- b.  $\pi < \arg z \leq \frac{3\pi}{2}$ .

The desired set is given by all the points of quadrant III, to which ray  $|Oy$  is added, so all the points with  $x < 0, y < 0$ .

$$c. \left. \begin{array}{l} \arg z > \frac{4\pi}{3}, z \neq 0 \\ \arg z \in [0, 2\pi] \end{array} \right\} \Rightarrow \frac{4\pi}{3} < \arg z < 2\pi$$

$$\left. \begin{array}{l} \arg z > \frac{4\pi}{3}, z \neq 0 \\ \arg z \in [0, 2\pi] \end{array} \right\} \Rightarrow \frac{4\pi}{3} < \arg z < 2\pi$$

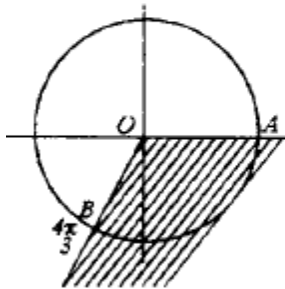

$$\begin{aligned} x_B &= \cos \frac{4\pi}{3} = \cos \left( \pi + \frac{\pi}{3} \right) = -\cos \frac{\pi}{3} = -\frac{1}{2} \\ y_B &= \sin \frac{4\pi}{3} = -\sin \frac{\pi}{3} = -\frac{\sqrt{3}}{2} \\ m_{OB} &= \frac{-\frac{\sqrt{3}}{2}}{-\frac{1}{2}} = \sqrt{3} \Rightarrow OB : y = \sqrt{3}x \end{aligned}$$

The desired set is that of the internal points of the angle with its sides positive semi-axis and ray  $|OB$ .

- d.  $|z + i| \leq 2$ ;  $z = x + yi$ , its geometric image  $M$ .

$$z + i = x + yi + i = x + (y + 1)i$$

$$|z + i| = \sqrt{x^2 + (y + 1)^2} \leq 2 \Rightarrow \|O'M\| \leq 2 \Rightarrow x^2 + (y + 1)^2 \leq 4 \Rightarrow \|O'M\|^2 \leq 4$$

where  $O'(0, -1)$ .

Thus, the desired set is the disk centered at  $O'_{(0,-1)}$  and radius 2.

Solution to [Problem 105](#).

$$\varepsilon_k = \cos \frac{2k\pi}{n} + i \sin \frac{2k\pi}{n}, \quad k = 0, 1, \dots, n-1$$

$$\varepsilon_1 = \cos \frac{2\pi}{n} + i \sin \frac{2\pi}{n} \quad .$$

$$\varepsilon_k = \cos k \frac{2\pi}{n} + i \sin k \frac{2\pi}{n} = \left( \cos \frac{2\pi}{n} + i \sin \frac{2\pi}{n} \right)^k = \varepsilon_1^k, \quad k = 2, 3, \dots, n-1$$

Solution to [Problem 106](#).

Let the equation  $z^4 = n$ . If  $z^4 = 4$  ( $z$  is the solution) then:  $(-z)^4 = (-1)^4 z^4 = 1 \cdot n = n$ , so  $-z$  is also a solution.

$$(iz)^4 = i^4 z^4 = 1 \cdot n = n$$

$\Rightarrow iz$  is the solution;

$$(-iz)^4 = (-i)^4 z^4 = 1 \cdot n = n$$

$\Rightarrow -iz$  is the solution;

$$\begin{aligned} (1-2i)^4 &= [(1-2i)^2]^2 = (1-4i+4i^2)^2 = (1-4-4i)^2 = (-3+4i)^2 = 9+24i-16 = \\ &= -7+24i \Rightarrow z = 1-2i \end{aligned}$$

$\Rightarrow$  is the solution of the equation  $z^4 = -7+24i$ .

The solutions of this equation are:

$$z_k = \sqrt[4]{-7+24i}, \quad k = 0, 1, 2, 3$$

but based on the first part, if  $z = 1-2i$  is a root, then

$$-z = -1+2i, iz = 2+i, -iz = -2-i$$

are solutions of the given equation.

Solution to [Problem 107](#).

$$z^m - 1 = 0 \Rightarrow z = \sqrt[m]{1} \Rightarrow z_k = \cos \frac{2k\pi}{m} + i \sin \frac{2k\pi}{m}, \quad k = 0, \dots, m-1$$

$$z^n - 1 = 0 \Rightarrow z = \sqrt[n]{1} \Rightarrow z_k = \cos \frac{2k\pi}{n} + i \sin \frac{2k\pi}{n}, \quad k = 0, \dots, n-1$$

If there exist  $k$  and  $k'$  with  $z_k = z_{k'}$ , then

$$\frac{2k\pi}{m} - \frac{2k'\pi}{n} = 2p\pi = mn|k'm - kn \Rightarrow n|k', m|k,$$

because  $(m, n) = 1$ . Because  $k' < n, k < m$ , we have  $k' = 0, k = 0$ .

Thus the common root is  $z_0$ .

Solution to [Problem 108](#).

$$(2 - 3i)z^6 + 1 + 5i = 0 \Rightarrow z^6 = \frac{-1 - 5i}{2 - 3i} = 1 - i$$

$$r = \sqrt{2}$$

$$\operatorname{tg} t = -1, t \in \left(\frac{3\pi}{2}, 2\pi\right) \Rightarrow t = 2\pi - \frac{\pi}{4} = \frac{7\pi}{4}$$

$$z_k = \sqrt[6]{2} \left( \cos \frac{\frac{7\pi}{4} + 2k\pi}{6} + i \sin \frac{\frac{7\pi}{4} + 2k\pi}{6} \right); k \in 0, \dots, 5$$

Solution to [Problem 109](#).

$$a) \left. \begin{array}{l} z^6 - 9z^3 + 8 = 0 \\ z^3 = y \end{array} \right\} \Rightarrow y^2 - 9y + 8 = 0 \Rightarrow \begin{cases} z^3 = 8 \\ z^3 = 1 \end{cases} \text{ etc.}$$

$$b) \left. \begin{array}{l} z^8 - 2z^4 + 2 = 0 \\ z^4 = y \end{array} \right\} \Rightarrow y^2 - 2y + 2 = 0 \Rightarrow \begin{cases} z^4 = 1 + i \\ z^4 = 1 - i \end{cases} \text{ etc.}$$

$$c) \left. \begin{array}{l} z^4 + 6(1 + i)z^2 + 5 + 6i = 0 \\ z^2 = y \end{array} \right\} \Rightarrow y^2 + 6(1 + i)y + 5 + 6i = 0$$

$$y_{1,2} = \frac{-6(1 + i) \pm \sqrt{-20 + 48i}}{2} = \frac{-6(1 + i) \pm \sqrt{(4 + 6i)2}}{2} \text{ etc.}$$

Solution to [Problem 110](#).

$$\left. \begin{array}{l} z = x + iy \Rightarrow |z| = \sqrt{x^2 + y^2} \\ \bar{z} = x - iy \Rightarrow |\bar{z}| = \sqrt{x^2 + y^2} \end{array} \right\} \Rightarrow |z| = |\bar{z}|$$

As:

$$\left. \begin{array}{l} \bar{z} = z^{n-1} \Rightarrow |\bar{z}| = |z|^{n-1} \\ |z| = |\bar{z}| \end{array} \right\} \Rightarrow |z| = |z|^{n-1} \Rightarrow |z| \cdot (1 - |z|^{n-2}) = 0 \Rightarrow \begin{cases} |z| = 0 \\ |z|^{n-2} - 1 = 0 \end{cases}$$

From:

$$|z| = 0 \Rightarrow \sqrt{x^2 + y^2} = 0 \Rightarrow x^2 + y^2 = 0 \Rightarrow x = 0 \text{ și } y = 0 \Rightarrow z = 0 + 0i$$

$$|z|^{n-2} - 1 = 0 \Rightarrow (|z| - 1) \underbrace{(|z|^{n-3} + |z|^{n-4} + \dots + 1)}_{\text{positive}} = 0 \Rightarrow |z| = 1 \Rightarrow x^2 + y^2 = 1$$

$$\left. \begin{array}{l} z = x + iy \\ \bar{z} = x - iy \end{array} \right\} \Rightarrow z\bar{z} = x^2 + y^2 = 1$$

The given equation becomes

$$\bar{z} \cdot z = z^n \Rightarrow z^n = 1 \Rightarrow z_k = \cos \frac{2k\pi}{n} + i \sin \frac{2k\pi}{n}, k = 0, 1, \dots, n-1$$

Solution to [Problem 111](#).

$$A(z_1), B(z_2), C(z_3), D(z_4)$$

$$\Rightarrow M \left( \frac{z_1 + z_2}{2} \right), N \left( \frac{z_2 + z_3}{2} \right), P \left( \frac{z_3 + z_4}{2} \right), Q \left( \frac{z_4 + z_1}{2} \right)$$

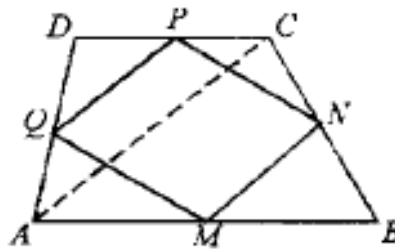

We find the sum of the abscissa of the opposite points:

$$\frac{z_1 + z_2}{2} + \frac{z_3 + z_4}{2} = \frac{z_1 + z_2 + z_3 + z_4}{2}$$

$$\frac{z_2 + z_3}{2} + \frac{z_4 + z_1}{2} = \frac{z_1 + z_2 + z_3 + z_4}{2}$$

$$\frac{z_1 + z_2}{2} + \frac{z_3 + z_4}{2} = \frac{z_2 + z_3}{2} + \frac{z_4 + z_1}{2}$$

$\Rightarrow MNPQ$  a parallelogram.

Solution to [Problem 112](#).

In the quadrilateral  $M_1M_3N_3N_1$  by connecting the midpoints we obtain the parallelogram  $O'P_1O''P_3$ , with its diagonals intersecting at  $O$ , the midpoint of  $|O'O''|$  and thus  $|P_1O| \equiv |OP_3|$ . (1)

In the quadrilateral  $M_4M_2N_2N_4$  by connecting the midpoints of the sides we obtain the parallelogram  $O'P_2O''P_4$  with its diagonals intersecting in  $O$ , the midpoint of  $|O'O''|$  and thus  $|P_2O| \equiv |OP_4|$ . (2)

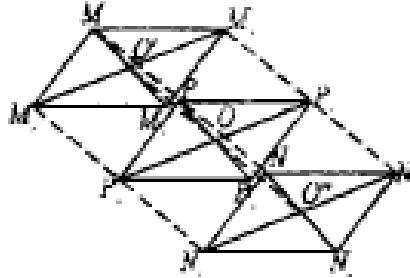

From (1) and (2)  $P_1P_2P_3P_4$  a parallelogram.

Solution to [Problem 113](#).

$$\begin{aligned} \|M'M\| &= |z - z'|, \text{ deci } \|M_1M_2\| = |z_2 - z_1| \\ \|M'_1M'_2\| &= |f(z_2) - f(z_1)| = |az_2 + b - az_1 - b| = \|az_2 - az_1\| = |a(z_2 - z_1)| = |a| \cdot |z_2 - z_1| = \\ &= |a| \cdot \|M_1M_2\| \end{aligned}$$

If:

$$|a| = 1 \Rightarrow \|M'_1M'_2\| = \|M_1M_2\|$$

If:

$$\left. \begin{aligned} \|M'_1M'_2\| &= \|M_1M_2\| \\ \|M'_1M'_2\| &= |a| \cdot \|M_1M_2\| \end{aligned} \right\} \Rightarrow \|M_1M_2\| = |a| \cdot \|M_1M_2\| \Rightarrow |a| = 1$$

Solution to [Problem 114](#).

$$z = x + iy, \bar{z} = x - iy$$

Let  $M_1$  and  $M_2$  be of affixes  $z_1$  and  $z_2$ . Their images through the given function  $M'_1$  and  $M'_2$  with affixes  $\bar{z}_1$  and  $\bar{z}_2$ , so

$$f(z_1) = \bar{z}_1, f(z_2) = \bar{z}_2$$

$$\|M_1M_2\| = |z_2 - z_1| = |x_2 + iy_2 - x_1 - iy_1| = \sqrt{(x_2 - x_1)^2 + (y_2 - y_1)^2} \quad (1)$$

$$\|M'_1M'_2\| = |\bar{z}_2 - \bar{z}_1| = \sqrt{(x_2 - x_1)^2 + (y_2 - y_1)^2} \quad (2)$$



From (1) and (2)  $\Rightarrow \|M_1M_2\| = \|M'_1M'_2\|$  or  $\|M'_1M'_2\| = |\bar{z}_2\bar{z}_1| = |\sqrt{z_2 - z_1}| = |z_2 - z_1| = \|M_1M_2\|$ .

So  $f: \mathbb{C} \rightarrow \mathbb{C}, f(z) = \bar{z}$  defines an isometry because it preserves the distance between the points.

Solution to [Problem 115](#).

We know that the argument  $(az_1) = \arg z_1 + \arg z_\alpha - 2k\pi$ , where  $k = 0$  or  $k = 1$ .  
Because  $\arg z_2 = \arg(az_1), \arg z_2 = \arg z_1 + \arg z_\alpha - 2k\pi$ .

a. We assume that

$$\begin{aligned} |OM_1| = |OM_2| &\Rightarrow \arg z_1 = \arg z_2 \Rightarrow \arg z_1 = \arg z_1 + \arg \alpha - 2k\pi \Rightarrow \\ &\Rightarrow \arg \alpha = 2k\pi, \arg \in [0, 2\pi] \Rightarrow \arg \alpha = 0 \Rightarrow \alpha \in |Ox \text{ (poz.)} \Rightarrow \alpha > 0. \end{aligned}$$

Vice versa,

$$\begin{aligned} \alpha > 0 \Rightarrow \arg \alpha = 0 \Rightarrow \arg z_2 = \arg z_1 - 2k\pi \Rightarrow \arg z_1 = \arg z_2 \text{ sau } \arg z_2 = \\ = \arg z_1 - 2\pi \Rightarrow |OM_1| = |OM_2|. \end{aligned}$$

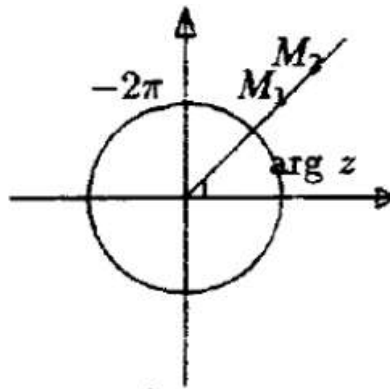

b. Let  $|OM_1$  and  $|OM_2$  be opposed  $\Rightarrow \arg z_2 = \arg z_1 + \pi$   
 $\Rightarrow \arg z_1 + \pi = \arg z_1 + \arg \alpha - 2k\pi \Rightarrow \arg \alpha = \pi$

$\in$  to the negative ray  $|Ox' \Rightarrow \alpha < 0$ . Vice versa,

$$\alpha < 0 \Rightarrow \arg \alpha = \pi \Rightarrow \arg z_2 = \arg z_1 + \pi - 2k\pi$$

$$k = 0 \text{ or } k = 1 \Rightarrow \left. \begin{array}{l} \arg z_2 = \arg z_1 + \pi \\ \text{or} \\ \arg z_2 = \arg z_1 - \pi \end{array} \right\} \Rightarrow |OM_1| \text{ and } |OM_2| \text{ are opposed.}$$

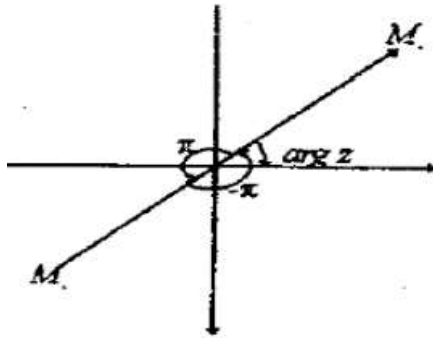

Solution to [Problem 116](#).

If  $n$  and  $n'$  are the geometric images of complex numbers  $z$  and  $z'$ , then the image of the difference  $z - z'$  is constructed on  $|OM_1|$  and  $|M'M|$  as sides.

We assume that  $M_3 \in |M_1M_2|$

We construct the geometric image of  $z_2 - z_1$ . It is the fourth vertex of the parallelogram  $OM_1M_2Q_1$ . The geometric image of  $z_3 - z_1$  is  $Q_2$ , the fourth vertex of the parallelogram  $OM_1M_3Q_2$ .

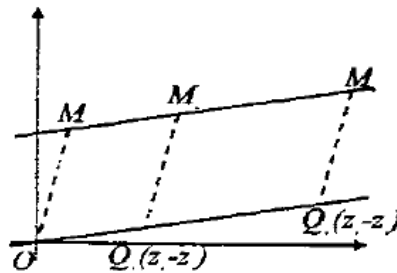

$$\left. \begin{array}{l} OQ_1 \parallel M_1M_2 \\ OQ_2 \parallel M_1M_3 \\ M_1M_2M_3 \text{ collinear} \end{array} \right\} \Rightarrow Q_1, Q_2, Q_3 \text{ collinear} \Rightarrow$$

$$|OQ_1| = |OQ_2| \Rightarrow z_3 - z_1 = \alpha(z_2 - z_1) \Rightarrow \frac{z_3 - z_1}{z_2 - z_1} = \alpha \Rightarrow \frac{z_3 - z_1}{z_2 - z_1} > 0$$

*Vice versa*, we assume that

$$\frac{z_3 - z_1}{z_2 - z_1} > 0 \Rightarrow \frac{z_3 - z_1}{z_2 - z_1} = k > 0 \Rightarrow z_3 - z_1 = k(z_2 - z_1), k > 0$$

$$\left. \begin{array}{l} OQ_1 = |OQ_2| \\ M_1M_2 \parallel OQ_1 \\ M_1M_3 \parallel OQ_2 \end{array} \right\} \Rightarrow |M_1M_2| = |M_1M_3| \Rightarrow M_3 \in |M_1M_2|$$

If  $M_3$  and  $M_2 \in$  the opposite ray to  $O$ , then  $z_3 - z_1 = \alpha(z_2 - z_1)$  with  $\alpha < 0$ .

We repeat the reasoning from the previous point for the same case.

Thus, when  $M_3 \in M_1M_2M_3 + M_2$  we obtain for the respective ratio positive, negative or having  $M_3 = M_1$ , so  $\frac{z_3 - z_1}{z_2 - z_1} \in \mathbb{R}$ .

Solution to [Problem 117](#).

The images of the roots of order 3 of the unit are the peaks of the equilateral triangle.

$$\varepsilon_0 = 1, \varepsilon_1 = \frac{-1 + i\sqrt{3}}{2}, \varepsilon_2 = \frac{-1 - i\sqrt{3}}{2}$$

But  $\varepsilon_1 = \varepsilon_2^2$ , so if we write  $\varepsilon_2 = \varepsilon$ , then  $\varepsilon_1 = \varepsilon^2$ .

Thus  $M_1(1), M_2(\varepsilon), M_3(\varepsilon^2)$ .

We use the equality:

$$(z-1)(\varepsilon^2 - \varepsilon) + (z-\varepsilon)(1 - \varepsilon^2) = (2 - \varepsilon^2)(1 - \varepsilon)$$

adequate  $(\forall)z \in \mathbb{C}$ .

$$|(z-1)(\varepsilon^2 - \varepsilon) + (z-\varepsilon)(1 - \varepsilon^2)| = |(z - \varepsilon^2)(1 - \varepsilon)|$$

But

$$|(z-1)(\varepsilon^2 - \varepsilon) + (z-\varepsilon)(1 - \varepsilon^2)| \leq |(z-1)(\varepsilon^2 - \varepsilon)| + |(z-\varepsilon)(1 - \varepsilon^2)|$$

$$|(z-1)(\varepsilon^2 - \varepsilon) + (z-\varepsilon)(1 - \varepsilon^2)| \geq |(z-1)(\varepsilon^2 - \varepsilon)| - |(z-\varepsilon)(1 - \varepsilon^2)|$$

Therefore,

$$|(z-1)(\varepsilon^2 - \varepsilon)| + |(z-\varepsilon)(1 - \varepsilon^2)| \geq |(z - \varepsilon^2)(1 - \varepsilon)|$$

$$|(z-1)(\varepsilon^2 - \varepsilon)| + |(z-\varepsilon)(1 - \varepsilon^2)| \geq |z - \varepsilon^2| \cdot |1 - \varepsilon|$$

$$\varepsilon = \frac{-1 - i\sqrt{3}}{2}, \varepsilon^2 = \frac{-1 + \sqrt{3}}{2} \Rightarrow \varepsilon^2 - \varepsilon = i\sqrt{3} = 0 + i\sqrt{3} \Rightarrow |\varepsilon^2 - \varepsilon| = \sqrt{3}$$

$$1 - \varepsilon^2 = -1 - \frac{-1 + i\sqrt{3}}{2} = \frac{3}{2} - i\frac{\sqrt{3}}{2} \quad |1 - \varepsilon^2| = \sqrt{\frac{9}{4} + \frac{3}{4}} = \sqrt{3}$$

$$1 - \varepsilon = 1 - \frac{-1 - i\sqrt{3}}{2} = \frac{3}{2} = \frac{i\sqrt{3}}{2}$$

$$|1 - \varepsilon| = \sqrt{\frac{9}{4} + \frac{3}{4}} = \sqrt{3}.$$

By substitution:

$$|z-1| \cdot \sqrt{3} + |z-\varepsilon| \cdot \sqrt{3} \geq |z - \varepsilon^2| \cdot \sqrt{3}$$

but

$$\|MM_1\| = |z-1|; \|MM_2\| = |z-\varepsilon|; \|MM_3\| = |z-\varepsilon^2|,$$

thus

$$\|MM_1\| + \|MM_2\| \geq \|MM_3\|$$

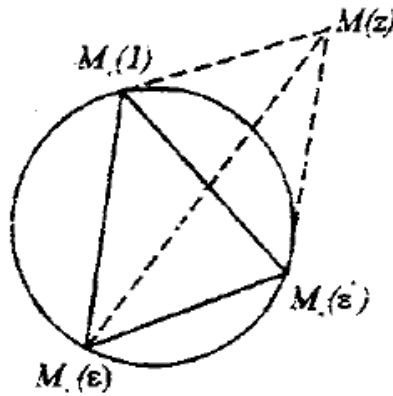

Therefore  $\|MM_1\|, \|MM_2\|, \|MM_3\|$  sides of a  $\Delta$ .

Then we use  $\|x\| - \|y\| \leq \|x - y\|$  and obtain the other inequality.

## Problems in Spatial Geometry

118. Show that if a line  $d$  is not contained in plane  $\alpha$ , then  $d \cap \alpha$  is  $\emptyset$  or it is formed of a single point.

[Solution to Problem 118](#)

119. Show that  $(\forall) \alpha, (\exists)$  at least one point which is not situated in  $\alpha$ .

[Solution to Problem 119](#)

120. The same; there are two lines with no point in common.

[Solution to Problem 120](#)

121. Show that if there is a line  $d$   $(\exists)$  at least two planes that contain line  $d$ .

[Solution to Problem 121](#)

122. Consider lines  $d, d', d''$ , such that, taken two by two, to intersect. Show that, in this case, the 3 lines have a common point and are located on the same plane.

[Solution to Problem 122](#)

123. Let  $A, B, C$  be three non-collinear points and  $D$  a point located on the plane  $(ABC)$ . Show that:

- a. The points  $D, A, B$  are not collinear, and neither are  $D, B, C; D, C, A$ .
- b. The intersection of planes  $(DAB), (DBC), (DCA)$  is formed of a single point.

[Solution to Problem 123](#)

124. Using the notes from the previous exercise, take the points  $E, F, G$  distinct from  $A, B, C, D$ , such that  $E \in AD, F \in BD, G \in CD$ . Let  $BC \cap FG = \{P\}, GE \cap CA = \{Q\}, EF \cap AB = \{R\}$ . Show that  $P, Q, R$  are collinear (*T. Desargues*).

[Solution to Problem 124](#)

125. Consider the lines  $d$  and  $d'$  which are not located on the same plane and the distinct points  $A, B, C \in d$  and  $D, E \in d'$ . How many planes can we draw such that each of them contains 3 non-collinear points of the given points? Generalization.

[Solution to Problem 125](#)

126. Show that there exist infinite planes that contain a given line  $d$ .

[Solution to Problem 126](#)

127. Consider points  $A, B, C, D$  which are not located on the same plane.

- How many of the lines  $AB, AC, AD, BC, BD, CD$  can be intersected by a line that doesn't pass through  $A, B, C, D$ ?
- Or by a plane that doesn't pass through  $A, B, C, D$ ?

[Solution to Problem 127](#)

128. The points  $\alpha$  and  $\beta$  are given,  $A, B \in \alpha$ . Construct a point  $M \in \alpha$  at an equal distance from  $A$  and  $B$ , that  $\in$  also to plan  $\beta$ .

[Solution to Problem 128](#)

129. Determine the intersection of three distinct planes  $\alpha, \beta, \gamma$ .

[Solution to Problem 129](#)

130. Given: plane  $\alpha$ , lines  $d_1, d_2$  and points  $A, B \notin \alpha \cup d_1 \cup d_2$ . Find a point  $M \in \alpha$  such that the lines  $MA, MB$  intersect  $d_1$  and  $d_2$ .

[Solution to Problem 130](#)

131. There are given the plane  $\alpha$ , the line  $d \notin \alpha$ , the points  $A, B \notin \alpha \cup d$ , and  $C \in \alpha$ . Let  $M \in d$  and  $A', B'$  the points of intersection of the lines  $MA, MB$  with plane  $\alpha$  (if they exist). Determine the point  $M$  such that the points  $C, A', B'$  to be collinear.

[Solution to Problem 131](#)

132. If points  $A$  and  $B$  of an open half-space  $\sigma$ , then  $[AB] \subset \sigma$ . The property is as well adherent for a closed half-space.

[Solution to Problem 132](#)

133. If point  $A$  is not situated on plane  $\alpha$  and  $B \in \alpha$  then  $|BA| \subset |\alpha A|$ .

[Solution to Problem 133](#)

134. Show that the intersection of a line  $d$  with a half-space is either line  $d$  or a ray or an empty set.

[Solution to Problem 134](#)

135. Show that if a plane  $\alpha$  and the margin of a half-space  $\sigma$  are secant planes, then the intersection  $\sigma \cap \alpha$  is a half-plane.

[Solution to Problem 135](#)

136. The intersection of a plane  $\alpha$  with a half-space is either the plane  $\alpha$  or a half-plane, or an empty set.

[Solution to Problem 136](#)

137. Let  $A, B, C, D$  four non coplanar points and  $\alpha$  a plane that doesn't pass through one of the given points, but it passes through a point of the line  $|AB|$ . How many of the segments  $|AB|, |AC|, |AD|, |BC|, |BD|, |CD|$  can be intersected by plane  $\alpha$ ?

[Solution to Problem 137](#)

138. Let  $d$  be a line and  $\alpha, \beta$  two planes such that  $d \cap \beta = \emptyset$  and  $\alpha \cap \beta = \emptyset$ .

Show that if  $A \in d$  and  $B \in \alpha$ , then  $d \subset |\beta A$  and  $\alpha \subset |\beta B$ .

[Solution to Problem 138](#)

139. Let  $|\alpha A$  and  $|\beta B$  be two half-spaces such that  $\alpha \neq \beta$  and  $|\alpha A \subset |\beta B$  or

$|\alpha A \cap |\beta B = \emptyset$ . Show that  $\alpha \cap \beta = \emptyset$ .

[Solution to Problem 139](#)

140. Show that the intersection of a dihedral angle with a plane  $\alpha$  can be: a right angle, the union of two lines, a line, an empty set or a closed half-plane and cannot be any other type of set.

[Solution to Problem 140](#)

141. Let  $d$  be the edge of a proper dihedron  $\angle \alpha' \beta'$ ,  $A \in \alpha' - d$ ,  $b \in \beta' - d$  and

$P \in \text{int. } \angle \alpha' \beta'$ . Show that:

- a.  $(Pd) \cap \text{int. } \angle \alpha' \beta' = |dP$ ;
- b. If  $M \in d$ ,  $\text{int. } \angle AMB = \text{int. } \alpha' \beta' \cap (AMB)$ .

[Solution to Problem 141](#)

142. Consider the notes from the previous problem. Show that:

- a. The points  $A$  and  $B$  are on different sides of the plane  $(Pd)$ ;
- b. The segment  $|AB|$  and the half-plane  $|dP$  have a common point.

[Solution to Problem 142](#)

143. If  $\angle abc$  is a trihedral angle,  $P \in \text{int. } \angle abc$  and  $A, B, C$  are points on edges  $a, b, c$ , different from  $O$ , then the ray  $|OP$  and  $\text{int. } ABC$  have a common point.

[Solution to Problem 143](#)

144. Show that any intersection of convex sets is a convex set.

[Solution to Problem 144](#)



145. Show that the following sets are convex planes, half-planes, any open or closed half-space and the interior of a dihedral angle.

[Solution to Problem 145](#)

146. Can a dihedral angle be a convex set?

[Solution to Problem 146](#)

147. Which of the following sets are convex:

- a. a trihedral angle;
- b. its interior;
- c. the union of its faces;
- d. the union of its interior with all its faces?

[Solution to Problem 147](#)

148. Let  $\sigma$  be an open half-space bordered by plane  $\alpha$  and  $M$  a closed convex set in plane  $\alpha$ . Show that the set  $M \cap \sigma$  is convex.

[Solution to Problem 148](#)

149. Show that the intersection of sphere  $S(O, r)$  with a plane which passes through  $O$ , is a circle.

[Solution to Problem 149](#)

150. Prove that the int.  $S(O, r)$  is a convex set.

[Solution to Problem 150](#)

151. Show that, by unifying the midpoints of the opposite edges of a tetrahedron, we obtain concurrent lines.

[Solution to Problem 151](#)

152. Show that the lines connecting the vertices of a tetrahedron with the centroids of the opposite sides are concurrent in the same point as the three lines from the previous example.

[Solution to Problem 152](#)

153. Let  $ABCD$  be a tetrahedron. We consider the trihedral angles which have as edges  $[AB], [AC], [AD], [BA], [BC], [BD], [CA], [CB], [CD], [DA], [DB], [DC]$ . Show that the intersection of the interiors of these 4 trihedral angles coincides with the interior of tetrahedron  $[ABCD]$ .

[Solution to Problem 153](#)

154. Show that  $(\forall) M \in \text{int.}[ABCD] (\exists) P \in |AB|$  and  $Q \in |CD|$  such that  $M \in \text{int.}PQ$ .

[Solution to Problem 154](#)

155. The interior of tetrahedron  $[ABCD]$  coincides with the union of segments  $|PQ|$  with  $P \in |AB|$  and  $Q \in |CD|$ , and tetrahedron  $[ABCD]$  is equal to the union of the closed segments  $[PQ]$ , when  $P \in [AB]$  and  $Q \in [CD]$ .

[Solution to Problem 155](#)

156. The tetrahedron is a convex set.

[Solution to Problem 156](#)

157. Let  $M_1$  and  $M_2$  convex sets. Show that by connecting segments  $[PQ]$ , for which  $P \in M_1$  and  $Q \in M_2$  we obtain a convex set.

[Solution to Problem 157](#)

158. Show that the interior of a tetrahedron coincides with the intersection of the open half-spaces determined by the planes of the faces and the opposite peak. Define the tetrahedron as an intersection of half-spaces.

[Solution to Problem 158](#)

## Solutions

Solution to [Problem 118](#).

We assume that  $d \cap \alpha = \{A, B\} \Rightarrow d \subset \alpha$ .

It contradicts the hypothesis  $\Rightarrow d \cap \alpha = \{A\}$  or  $d \cap \alpha = \emptyset$ .

Solution to [Problem 119](#).

We assume that all the points belong to the plane  $\alpha \Rightarrow (\nexists)$  for the points that are not situated in the same plane. False!

Solution to [Problem 120](#).

$\exists A, B, C, D$ , which are not in the same plane. We assume that  $AB \cap CD = \{0\} \Rightarrow AB$  and  $CD$  are contained in the same plane and thus  $A, B, C, D$  are in the same plane. False, it contradicts the hypothesis  $\Rightarrow AB \cap CD = \emptyset \Rightarrow (\exists) \Rightarrow$  lines with no point in common.

Solution to [Problem 121](#).

$(\exists) A \notin d$  (if all the points would  $\in d$ , the existence of the plane and space would be negated). Let  $\alpha = (dA)$ ,  $(\exists) B \notin \alpha$  (otherwise the space wouldn't exist). Let  $\beta = (Bd)$ ,  $\alpha \neq \beta$  and both contain line  $d$ .

Solution to [Problem 122](#).

We show that  $d \neq d' \neq d'' \neq d$ .

Let

$$d \cap d' = \{A\} = (d, d') \Rightarrow \begin{cases} d \subset \alpha \\ d' \subset \alpha \end{cases}$$

$$\begin{matrix} d \cap d' = \{B\} \\ B \neq A \end{matrix} \Rightarrow \begin{cases} B \in d \\ d \subset \alpha \end{cases} \Rightarrow B \in \alpha, B \in d'$$

$$\begin{aligned}
 d'' \cap d' = \{C\} \\
 C \neq B \\
 C \neq A
 \end{aligned}
 \Rightarrow
 \begin{aligned}
 C \in d' \\
 d' \subset \alpha
 \end{aligned}
 \Rightarrow C \in \alpha, C \in d''$$

$$\begin{aligned}
 & d = d' \\
 \Rightarrow & \text{ or} \\
 & d = d''
 \end{aligned}$$

$\Rightarrow d'' \subset \alpha$ , so the lines are located on the same plane  $\alpha$ .

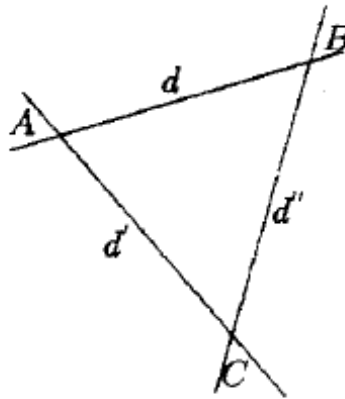

If  $\left. \begin{aligned} d \cap d' = \{A\} \Rightarrow A \in d' \\ d'' \cap d = \{A\} \Rightarrow A \in d'' \end{aligned} \right\} \Rightarrow d' \cap d'' = \{A\}$ , and the three lines have a point in common.

Solution to [Problem 123](#).

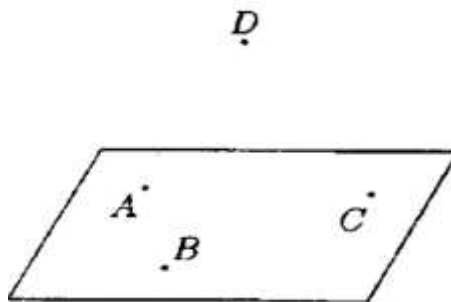

a.  $D \notin (ABC)$ .

We assume that  $D, A, B$  collinear  $\Rightarrow (\exists) d$  such that  $\left. \begin{aligned} D \in d, A \in d, B \in d \\ A \in (ABC), B \in (ABC) \end{aligned} \right\} \stackrel{T_2}{\Rightarrow} d \subset (ABC) \Rightarrow D \in (ABC)$  – false. Therefore, the points  $D, A, B$  are not collinear.

b. Let  $(DAB) \cap (BCD) \cap (DCA) = E$ .

As the planes are distinct, their intersections are:

$$\left. \begin{aligned} (DAB) \cap (DBC) &= DB \\ (DAB) \cap (DCA) &= DA \\ (DBC) \cap (DCA) &= DC \end{aligned} \right\} \Rightarrow \text{If } (DAB) = (DBC) \\ \Rightarrow A, B, C, D \text{ coplanar, contrary to the hypothesis.}$$

We suppose that  $(\exists)M \in E, M \neq D \Rightarrow \left. \begin{aligned} M \in DB \\ M \in DA \end{aligned} \right\} \Rightarrow \left. \begin{aligned} B \in MD \\ A \in MD \end{aligned} \right\} \Rightarrow A, B, D \text{ are collinear}$   
 (false, contrary to point a.). Therefore, set  $E$  has a single point  $E = \{D\}$ .

Solution to [Problem 124](#).

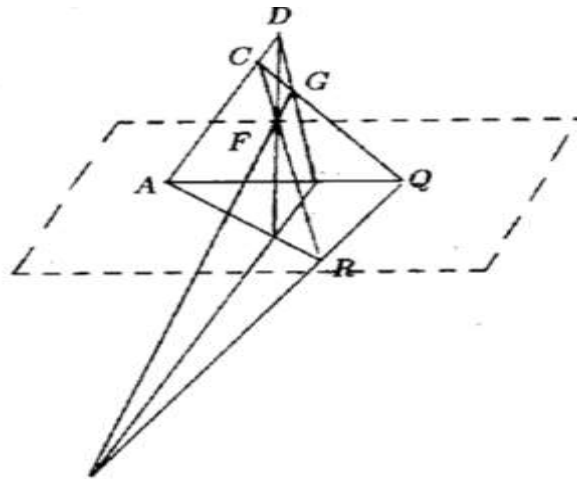

We showed at the previous exercise that if  $D \notin (ABC), (DAB) \neq (DBC)$ . We show that  $E, F, G$  are not collinear. We assume the opposite. Then,

$$\left. \begin{aligned} G \in EF \\ EF \subset (DAB) \end{aligned} \right\} \Rightarrow \left\{ \begin{aligned} G \in (DAB) \\ G \in (DBC) \end{aligned} \right. \Rightarrow \\ \Rightarrow (DAB) = (DBC)$$

Having three common points  $D, B$  and  $G \Rightarrow$  false. So  $E, F, G$  are not collinear and determine a plane  $(EFG)$ .

$$\left. \begin{aligned} P \in BC &\Rightarrow P \in (ABC) \\ P \in FG &\Rightarrow P \in (EFG) \\ R \in AB &\Rightarrow R \in (ABC) \\ R \in EF &\Rightarrow R \in (EFG) \\ Q \in CA &\Rightarrow P \in (ABC) \\ Q \in GE &\Rightarrow P \in (EFG) \end{aligned} \right\} P, Q, R \in (ABC) \cap (EFG) \Rightarrow$$

$\Rightarrow P, Q, R$  are collinear because  $\in$  to the line of intersection of the two planes.

Solution to [Problem 125](#).

The planes are  $(A, d')$ ;  $(B, d')$ ;  $(C, d')$ .

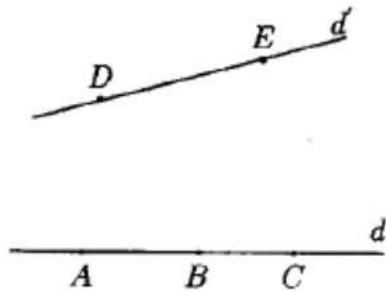

*Generalization:* The number of planes corresponds to the number of points on line  $d$  because  $d'$  contains only 2 points.

Solution to [Problem 126](#).

Let line  $d$  be given, and  $A$  any point such that  $A \notin d$ .

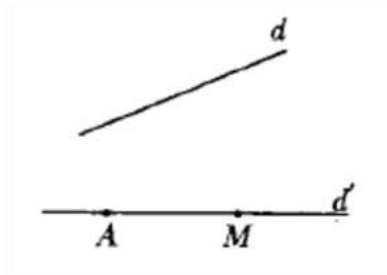

We obtain the plane  $\alpha = (A, d)$ , and let  $M \notin \alpha$ . The line  $d' = AM$ ,  $d' \notin \alpha$  is not thus contained in the same plane with  $d$ . The desired planes are those of type  $(Md)$ ,  $M \in d'$ , that is an infinity of planes.

Solution to [Problem 127](#).

a.  $(\forall)$  3 points determine a plane. Let plane  $(ABD)$ . We choose in this plane  $P \in |AD|$  and  $Q \in |AB|$  such that  $P \in |BQ|$ , then the line  $PQ$  separates the points  $A$  and  $D$ , but does not separate  $A$  and  $B$ , so it separates  $P$  and  $D \Rightarrow PQ \cap |BD| = R$ , where  $R \in |BD|$ .

Thus, the line  $PQ$  meets 3 of the given lines. Let's see if it can meet more.

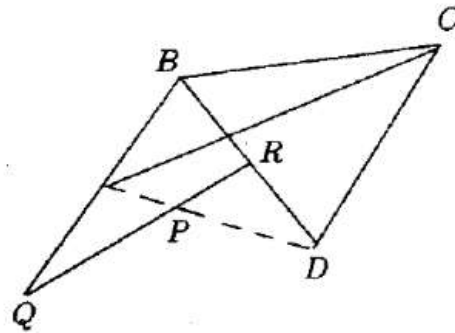

We assume that

$$PQ \cap BC = \{E\} \Rightarrow E \in PQ \subset (ABD) \Rightarrow \left. \begin{array}{l} E \in (ABD) \\ E \in BC \end{array} \right\} \Rightarrow$$

it has two points in common with the plane.

$$\Rightarrow \left\{ \begin{array}{l} B \in (ABD) \\ B \in BQ \end{array} \right. \Rightarrow BC \subset (ABD)$$

$\Rightarrow A, B, C, D$  coplanar – false.

Thus,

$$\left. \begin{array}{l} BC \cap (ABD) = \{E\} \\ BC \cap (ABD) = \{B\} \end{array} \right\} \Rightarrow E = B \Rightarrow B \in PQ.$$

false.

We show in the same way that  $PQ$  does not cut  $AC$  or  $DC$ , so a line meets at most three of the given lines.

b. We consider points  $E, F, G$  such that  $E \in |BC|, A \in |DF|, D \in |BG|$ . These points determine plane  $(EFG)$  which obviously cuts the lines  $BC, BD$  and  $BD$ .  $FG$  does not separate  $A$  and  $D$  or  $BD \Rightarrow$  it does not separate  $A$  or  $B \Rightarrow A \in |BR|$ .

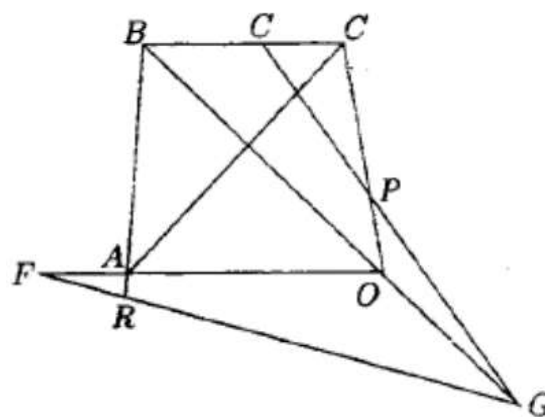

Let's show that  $(EFG)$  meets as well the lines  $AB, CD, AC$ . In the plane  $(ABD)$  we consider the triangle  $FDG$  and the line  $AB$ .

As this line cuts side  $|FD|$ , but it does not cut  $|DG|$ , it must cut side  $|FG|$ , so  $AB \cap |FG| = \{R\} \Rightarrow R \in |FG| \subset (EFG)$ , so  $AB \cap (EFG) = \{R\}$ . In the plane  $(BCD)$ , the line  $EG$  cuts  $|BC|$  and does not cut  $|BD|$ , so  $EG$  cuts the side  $|CD|$ ,  $EG \cap |CD| = \{P\} \Rightarrow P \in EG \subset (EFG) \Rightarrow CD \cap (EFG) = \{P\}$ .

$$\left. \begin{array}{l} R \in (EFG), R \text{ does not separate } A \text{ and } B \\ E \text{ separates } B \text{ and } C \end{array} \right\} \Rightarrow R \in \cap |AC| = Q \Rightarrow Q \in RE \Rightarrow Q \in (EFG) \cap AC = \{Q\}.$$

Solution to [Problem 128](#).

We assume problem is solved, if  $\left. \begin{array}{l} M \in \alpha \\ M \in \beta \end{array} \right\} \Rightarrow \alpha \cap \beta \neq \emptyset, \Rightarrow \alpha \cap \beta = d$ .

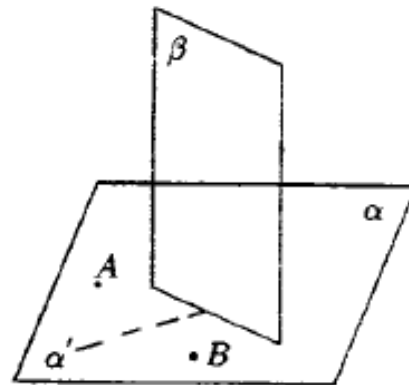

As  $||MA|| = ||MB|| \Rightarrow M \in$  the bisecting line of the segment  $[AB]$ .

So, to find  $M$ , we proceed as follows:

1. We look for the line of intersection of planes  $\alpha$  and  $\beta$ ,  $d$ . If  $\alpha \parallel \beta$ , the problem hasn't got any solution.
2. We construct the bisecting line  $d'$  of the segment  $[AB]$  in the plane  $\alpha$ .
3. We look for the point of intersection of lines  $d$  and  $d'$ . If  $d \parallel d'$ , the problem hasn't got any solution.



Solution to [Problem 129](#).

If  $\alpha \cap \beta = \emptyset \Rightarrow \alpha \cap \beta \cap \gamma = \emptyset$ . If  $\alpha \cap \beta = d$ , the desired intersection is  $d \cap \gamma$ , which can be a point (the 3 planes are concurrent), the empty set (the line of intersection of two planes is  $\parallel$  with the third) or line  $d$  (the 3 planes which pass through  $d$  are secant).

Solution to [Problem 130](#).

To determine  $M$ , we proceed as follows:

1. We construct plane  $(Ad_1)$  and we look for the line of intersection with  $\alpha_1, d_1$ .  
If  $d_1 (\nexists), \nexists$  neither does  $M$ .
2. We construct plane  $(Bd_2)$  and we look for the line of intersection with  $\alpha, d_2'$ .  
If  $d_2'$  does not exist, neither does  $M$ .
3. We look for the point of intersection of lines  $d_1'$  and  $d_2'$ . The problem has only one solution if the lines are concurrent, an infinity if they are coinciding lines and no solution if they are parallel.

Solution to [Problem 131](#).

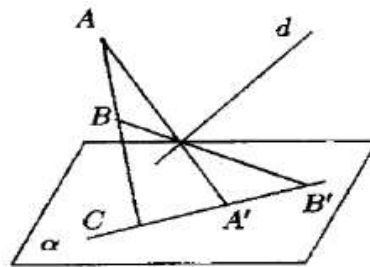

We assume the problem is solved.

- a. First we assume that  $A, B, C$  are collinear. As  $AA'$  and  $BB'$  are concurrent lines, they determine a plane  $\beta$ , that intersects  $\alpha$  after line  $A'B'$ .

As

$$\left. \begin{array}{l} C \in AB \Rightarrow C \in \beta \\ C \in \alpha \end{array} \right\} \Rightarrow C \in \alpha \cup \beta \Rightarrow C \in A'B'$$

and points  $C, A, B'$  are collinear  $(\forall)M \in d$ .

b. We assume that  $A, B, C$  are not collinear.

We notice that:  $(AA', BB') = \beta$  (plane determined by 2 concurrent lines).

$\beta \cup \alpha = d'$  and  $C \in d'$ .

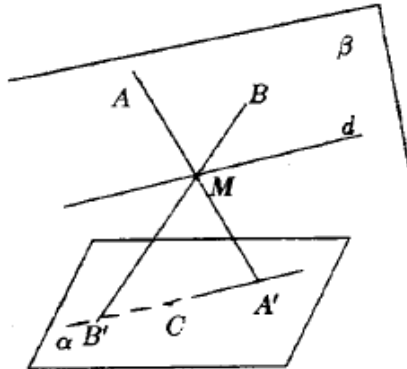

To determine  $M$  we proceed as follows:

- 1) We determine plane  $(ABC)$ ;
- 2) We look for the point of intersection of this plane with line  $d$ , so  $d \cap (ABC) = \{M\}$  is the desired point.

Then  $(ABC) \cap \alpha = d'$ .

$$\left. \begin{array}{l} AM \cap \alpha = \{A'\} \\ BM \cap \beta = \{B'\} \end{array} \right\} \Rightarrow A'B \in d' \left. \begin{array}{l} C \in \{A'\} \\ C \in \alpha \end{array} \right\} \Rightarrow C \in d'$$

$\Rightarrow A', B', C'$  are collinear.

Solution to [Problem 132](#).

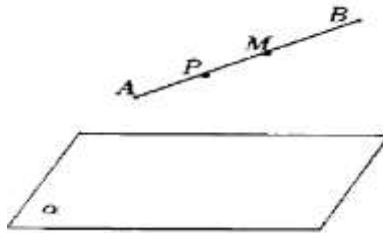

$A \in \sigma$  and  $B \in \sigma \Rightarrow [AB] \cap \alpha \neq \emptyset$ .

Let  $\sigma = ]\alpha A = ]\alpha B$ .

Let  $M \in ]AB]$  and we must show that  $M \in \sigma(\forall)M$  inside the segment.

We assume the contrary that  $M \notin \sigma \Rightarrow (\exists)P$  such that  $[AM] \cap d = \{P\} \Rightarrow P \in [AM] \Rightarrow P \in [AB] \Rightarrow [AB] \cap \alpha \neq \emptyset$  false.

$P \in \alpha$ , so  $M \in \sigma$ . The property is also maintained for the closed half-space.

Compared to the previous case there can appear the situation when one of the points  $A$  and  $B \in \alpha$  or when both belong to  $\alpha$ .

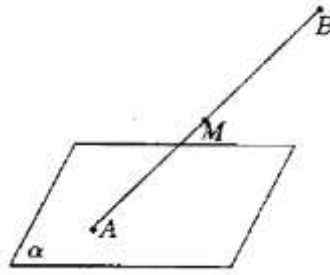

If  $A \in \alpha, B \in \sigma, |AB| \cap \alpha \neq \emptyset$  and we show as we did above that:

$$\left. \begin{array}{l} |AB| \subset \sigma \\ A \in \alpha \\ B \in \sigma \end{array} \right\} \Rightarrow [AB] \subset \sigma \cup \alpha$$

If:

$$A, B \in \alpha \Rightarrow AB \subset \alpha \Rightarrow [AB] \subset \alpha \Rightarrow [AB] \subset \alpha \cup \sigma.$$

Solution to [Problem 133](#).

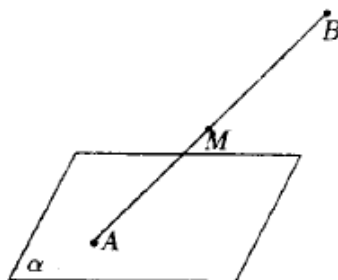

Let

$$\begin{aligned} M \in |BA| &\Rightarrow B \notin [MA] \Rightarrow [MA] \cap \alpha = \emptyset \\ &\Rightarrow M \in |\alpha A| \end{aligned}$$

So

$$|BA| \subset |\alpha A|$$

Solution to [Problem 134](#).

Let  $\alpha$  be a plane and  $\sigma_1, \sigma_2$  the two half-spaces that it determines. We consider half-space  $\sigma_1$ .

$$d \cap \alpha = \emptyset$$

1)  $d \cap \sigma_1 = \emptyset$

2)  $d \cap \sigma_1 \neq \emptyset$ , fix  $A \in d \cap \sigma_1 \Rightarrow \begin{cases} A \in \sigma_1 \\ A \in d \end{cases}$

$\left. \begin{array}{l} M \in d \Rightarrow [AM] \subset d \\ d \cap \alpha = \emptyset \end{array} \right\} \Rightarrow \left. \begin{array}{l} [AM] \cap \alpha = \emptyset \\ A \in \sigma_1 \end{array} \right\} \Rightarrow M \in \sigma_1, (\forall) M \in d \Rightarrow d \subset \sigma_1 \Rightarrow \\ \Rightarrow d \cap \sigma_1 = d$

3)  $d \cap \alpha \neq \emptyset \Rightarrow d \cap \alpha = \{P\} \Rightarrow$

$P$  determines on  $d$  two rays,  $|PA$  and  $|PB$  where

$\left. \begin{array}{l} P \in |AB| \\ P \in \alpha \end{array} \right\} \Rightarrow |AB| \cap \alpha \neq \emptyset \Rightarrow$

$A$  and  $B$  are in different half-spaces.

We assume

$\left. \begin{array}{l} A \in \sigma_1 \\ P \in \alpha \end{array} \right\} \xrightarrow{pr.2} |PA \subset \alpha \Rightarrow |PA \subset \sigma_1 \Rightarrow \sigma_1 \cap d = |PA.$

Solution to [Problem 135](#).

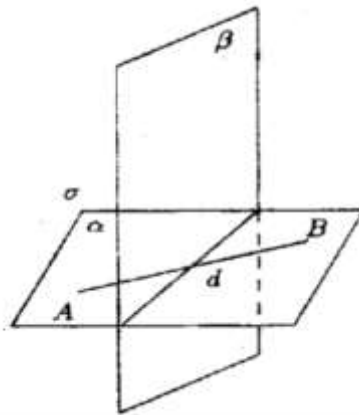

Let  $\sigma$  be an open half-space and  $p$  its margin and let  $d = \alpha \cap \beta$ .

We choose points  $A$  and  $B \in \alpha - d$ , on both sides of line  $d \Rightarrow$

$\left. \begin{array}{l} \Rightarrow [AB] \cap \beta \neq \emptyset \\ d \subset \beta \end{array} \right\} \Rightarrow [AB] \cap \beta \neq \emptyset$

$\Rightarrow A, B$  are on one side and on the other side of  $\beta$  and it means that only one of them is on  $\sigma$ .

We assume that  $A \in \sigma \Rightarrow B \in \sigma$ . We now prove  $\alpha \cap \sigma = |dA$ .

$\alpha \cap \sigma \subset |dA$

Let

$$\left. \begin{array}{l} M \in \alpha \cap \sigma \Rightarrow M \in \alpha, M \in \sigma \\ A \in \sigma, B \notin \sigma \end{array} \right\} \Rightarrow [MB] \cap B \neq \emptyset \quad \left. \begin{array}{l} M \in \alpha \\ B \in \alpha \end{array} \right\} \Rightarrow$$

$[MB] \in d \neq \emptyset \Rightarrow M$  and  $B$  are on one side and on the other side of line  $d \Rightarrow M$  is on the same side of line  $d$  with  $A \Rightarrow M \in |dA$

$$\left. \begin{array}{l} \Rightarrow M \in |dA \Rightarrow [MA] \cap d = \emptyset \\ \alpha \cap \beta = d \\ [MA] \subset \alpha \end{array} \right\} \Rightarrow [MA] \cap B = \emptyset \Rightarrow M \in |\beta A \Rightarrow \left. \begin{array}{l} M \in \sigma \\ M \in \alpha \end{array} \right\} \Rightarrow$$

$$\Rightarrow M \in \alpha \cap \sigma, \text{ so } |dA \subset \alpha \cap \sigma.$$

Solution to [Problem 136](#).

Let  $\sigma$  be the considered half-space and  $\beta$  its margin. There are more possible cases:

1)  $\alpha \cap \beta = \emptyset$

In this case it is possible that:

a)  $\alpha \cap \sigma = \emptyset$

b)  $\alpha \subset \sigma \neq \emptyset \Rightarrow (\exists) A \in \alpha \cap \sigma \Rightarrow \left. \begin{array}{l} A \in \alpha \\ A \in \sigma \end{array} \right\}$

Let

$$\left. \begin{array}{l} M \in \alpha \Rightarrow [MA] \subset \alpha \\ \alpha \cap \beta = \emptyset \end{array} \right\} \Rightarrow \left. \begin{array}{l} [MA] \cap \beta = \emptyset \\ A \in \sigma \end{array} \right\} \Rightarrow M \in \sigma, (\forall) M \in \alpha \Rightarrow \alpha \subset \sigma \Rightarrow \alpha \cap \sigma = \alpha$$

2)  $\alpha \cap \beta \neq \emptyset \Rightarrow \alpha \cap \beta = d \Rightarrow \alpha \cap \sigma$

is a half-plane according to a previous problem.

Solution to [Problem 137](#).

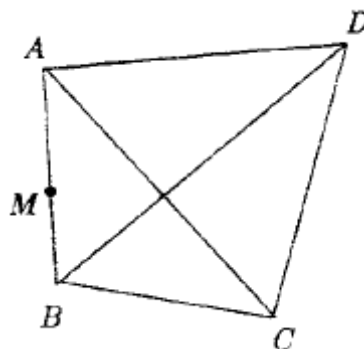

The intersection of two planes is a line and it cuts only two sides of a triangle.

There are more possible cases:

1.  $d$  cuts  $\underline{|AB|}$  and  $\underline{|BC|}$

$d'$  cuts  $|AB|$  and  $\underline{|AD|}$ ,  $\alpha$  cuts  $|AD|$  so it has a point in common with  $(ADC)$  and let  $(ADC) \cap \alpha = d''$ .

$d''$  cuts  $|AD|$  and does not cut  $|AC| \Rightarrow d''$  cuts  $|DC|$

$\alpha$  cuts  $|DC|$  and  $|BC| \Rightarrow$  it does not cut  $|BD|$ . In this case  $\alpha$  cuts 4 of the 6 segments (the underlined ones).

2.  $d$  cuts  $\underline{|AB|}$  and  $\underline{|AC|}$ , it does not cut  $|BD|$

$d'$  cuts  $|AB|$  and  $|AD|$ , it does not cut  $|BD|$

$d''$  cuts  $|AD|$  and  $|AC|$ , it does not cut  $|DC|$

$\Rightarrow \alpha$  does not intersect plane  $(BCD)$ . In this case  $\alpha$  intersects only 3 of the 6 segments.

3.  $d$  cuts  $\underline{|AB|}$  and  $|BC|$ , it does not cut  $|AC|$

$d'$  cuts  $|AB|$  and  $|BD|$ , it does not cut  $|DC|$

$\alpha$  intersects  $|BD|$  and  $|BC|$ , so it does not cut  $|DC|$

In  $\triangle BDC \Rightarrow \alpha$  does not intersect plane  $(ADC)$

In this case  $\alpha$  intersects only three segments.

4.  $d$  cuts  $\underline{|AB|}$  and  $\underline{|AC|}$ , it does not cut  $|BC|$

$d'$  cuts  $|AB|$  and  $\underline{|BD|}$ , it does not cut  $|AD|$

$d''$  cuts  $|AC|$  and  $\underline{|DC|}$

$\alpha$  does not cut  $|BC|$  in triangle  $BDC$ . So  $\alpha$  intersects 4 or 3 segments.

Solution to [Problem 138](#).

$$d \cap \beta = \emptyset$$

Let

$$\left. \begin{array}{l} M \in d \\ A \in d \end{array} \right\} \Rightarrow \left. \begin{array}{l} [AM] \subset d \\ d \cap \beta = \emptyset \end{array} \right\} \Rightarrow [AM] \cap \beta = \emptyset$$

$$\Rightarrow M \in |\beta A, (\forall) M \in d \Rightarrow d \subset |\beta A$$

Let

$$\left. \begin{array}{l} N \in \alpha \\ B \in \alpha \end{array} \right\} \Rightarrow \left. \begin{array}{l} [NB] \subset \alpha \\ \alpha \cap \beta = \emptyset \end{array} \right\} \Rightarrow [NB] \cap \beta = \emptyset$$

$$\alpha \subset |\beta B.$$

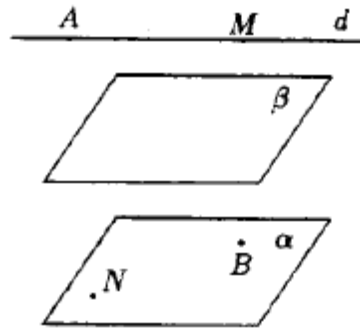

Solution to [Problem 139](#).

We first assume that  $\alpha \neq \beta$  and  $|\alpha A \subset |\beta B$ .

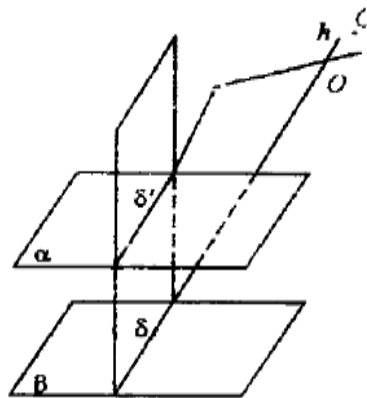

As

$$\left. \begin{array}{l} A \in |\alpha A \\ |\alpha A \subset |\beta B \end{array} \right\} \Rightarrow A \in |\beta B \Rightarrow |\beta B = |\beta A$$

The hypothesis can then be written as  $\alpha \neq \beta$  and  $|\alpha A \subset |\beta B$ . Let's show that  $\alpha \cap \beta = \emptyset$ . By reductio ad absurdum, we assume that  $\alpha \cap \beta \neq \emptyset \Rightarrow (\exists)d = \alpha \cap \beta$  and let  $O \in d$ , so  $O \in \alpha$  and  $O \in \beta$ . We draw through  $A$  and  $O$  a plane  $r$ , such that  $d \in r$ , so the three planes  $\alpha, \beta$  and  $r$  do not pass through this line. As  $r$  has the common point  $O$  with  $\alpha$  and  $\beta$ , it is going to intersect these planes.

$$\left. \begin{array}{l} r \cap \alpha = \delta' \\ r \cap \beta = \delta \end{array} \right\} \Rightarrow \delta \cap \delta' = O$$

which is a common point of the 3 planes. Lines  $\delta$  and  $\delta'$  determine 4 angles in plane  $r$ , having  $O$  as a common peak,  $A \in$  the interior of one of them, let  $A \in \text{int. } \widehat{hk}$ . We consider  $C \in \text{int. } \widehat{hk}$ .

Then  $C$  is on the same side with  $A$  in relation to  $\delta'$ , so  $C$  is on the same side with  $A$  in relation to  $\alpha \Rightarrow C \in |\alpha A$ .

But  $C$  is on the opposite side of  $A$  in relation to  $\delta$ , so  $C$  is on the opposite side of  $A$  in relation to  $\beta \Rightarrow C \notin |\beta A$ . So  $|\alpha A \not\subset |\beta A$  – false – it contradicts the hypothesis  $\Rightarrow$   
 So  $\alpha \cap \beta = \emptyset$ .

Solution to [Problem 140](#).

Let  $d$  be the edge of the given dihedral angle. Depending on the position of a line in relation to a plane, there can be identified the following situations:

$$1) d \cap \alpha = \{O\} \\ \Rightarrow \left\{ \begin{array}{l} O \in d \\ O \in \alpha \end{array} \right. \Rightarrow \left\{ \begin{array}{l} O \in \gamma \\ O \in \beta' \end{array} \right. \Rightarrow \left\{ \begin{array}{l} \gamma' \cap \alpha = d' \\ \beta' \cap \alpha = d'' \end{array} \right.$$

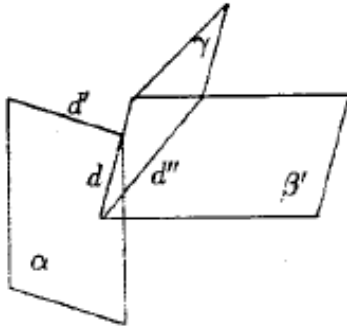

The ray with its origin in  $O$ , so  $\alpha \subset \widehat{\beta'\gamma'} = \widehat{d'd''}$  thus an angle.

$$2) d \cap \alpha = \emptyset \\ \left. \begin{array}{l} a) \alpha \cap \beta' \neq \emptyset \Rightarrow \alpha \cap \beta = d' \\ \alpha \cap \gamma' \neq \emptyset \Rightarrow \alpha \cap \gamma' = d'' \end{array} \right\} \Rightarrow d' \parallel d''$$

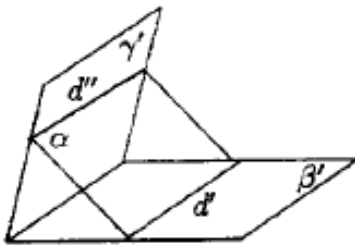

Indeed, if we assumed that  $d' \cap d'' \neq \emptyset \Rightarrow (\exists) O \in d' \cap d''$ .

$$\Rightarrow \left\{ \begin{array}{l} O \in d' \\ O \in d'' \end{array} \right. \Rightarrow \left\{ \begin{array}{l} O \in \beta' \\ O \in \gamma' \\ O \in \alpha \end{array} \right. \Rightarrow \left\{ \begin{array}{l} O \in d \\ O \in \alpha \end{array} \right. \Rightarrow O \in d \cap \alpha,$$

false – it contradicts the hypothesis.

$$b) \left\{ \begin{array}{l} \alpha \cap \beta' = d' \\ \alpha \cap \gamma' = \emptyset \end{array} \right.$$



Or

$$\begin{cases} \alpha \cap \beta' = \emptyset \\ \alpha \cap \gamma' = d'' \end{cases} \Rightarrow$$

in this case  $\alpha \cap \widehat{\beta'\gamma'} = d''$  - a line.

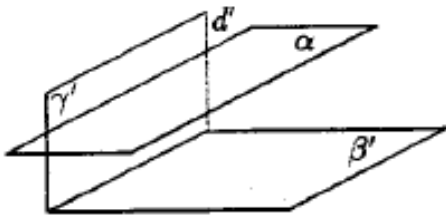

$$c) \begin{cases} \alpha \cap \beta' = \emptyset \\ \alpha \cap \gamma' = \emptyset \end{cases}$$

Then  $\alpha \cap \widehat{\beta'\gamma'} = \emptyset$ .

$$3) d \cap \alpha = d$$

a)

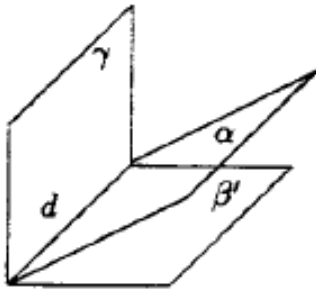

$d \cap \alpha = d$ , but  $\alpha \neq \beta$ ,  $\alpha \neq \gamma$

$\alpha \cap \widehat{\beta'\gamma'} = d$  thus the intersection is a line.

$$b) \alpha = \beta \quad \alpha = \gamma.$$

In this case the intersection is a closed half-plane.

Solution to [Problem 141](#).

$$1) \text{ int. } \widehat{\alpha'\beta'} = |\alpha B \cap |\beta A$$

$$P \in \text{int. } \widehat{\alpha'\beta'} \Rightarrow P \in \alpha B$$

$$P \in |\beta A$$

$$\alpha \cap (Pd) = d \stackrel{\text{Pr. 4}}{\Rightarrow} (Pd) \cap (\alpha B) \text{ is a half-plane} \quad P \in |\alpha B$$

$$\Rightarrow (Pd) \cap |\alpha B = dP \quad (*)$$

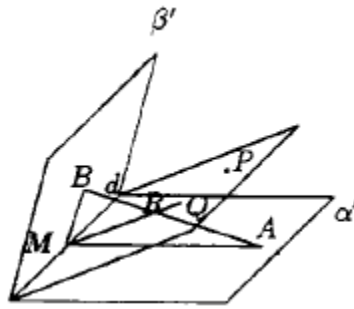

$$\left. \begin{aligned} (Pd) \cap \beta = d \Rightarrow (Pd) \cap |\beta A \text{ is a half-plane} \\ P \in |\beta A \end{aligned} \right\} \Rightarrow (Pd) \cap |\beta A = |dP \quad (**)$$

From (\*) and (\*\*),

$$\Rightarrow (Pd) \cap |\alpha B \cap |\beta A = |dP \Rightarrow (Pd) \cap \text{int. } \widehat{\alpha'\beta'} = |dP$$

$$2) (ABM) \cap \alpha = AM \text{ so they are secant planes } \xrightarrow{\text{pr. 4}} (AMB) \cap \beta A = |MB_1A$$

$$\begin{aligned} (AMB) \cap \text{int. } \widehat{\alpha'\beta'} &= (AMB) \cap |\alpha B \cap |\beta A = [(AMB) \cap |\alpha B] \cap [(AMB) \cap |\beta A] = \\ &= |MB_1A \cap |MA_1B = \text{int. } \widehat{AMB}. \end{aligned}$$

Solution to [Problem 142](#).

$$\left. \begin{aligned} M \in d \Rightarrow M \in dP \\ M \in (ABM) \end{aligned} \right\} \Rightarrow (AMB) \cap (dP) = d \text{ si } M \in d$$

$$\left. \begin{aligned} d \subset (dP) \\ d \cap d = M \end{aligned} \right\} \Rightarrow \left. \begin{aligned} |dP \cap d = |MQ \\ Q \in |dP \end{aligned} \right\} \Rightarrow \left. \begin{aligned} |MQ \subset |dP \subset \text{int. } \widehat{\alpha'\beta'} \\ |MQ \subset d \subset (AMB) \end{aligned} \right\} \Rightarrow$$

$$\Rightarrow |MQ \subset \text{int. } (\widehat{\alpha'\beta'}) \cap (ABM) \Rightarrow |MQ \subset \text{int. } \widehat{AMB} \Rightarrow \begin{aligned} |MQ \subset |AB| = \{R\} \\ |MQ \subset |dP \end{aligned}$$

$$\Rightarrow |dP \cap |AB| = \{R\} \quad |dP \subset (dP) \quad (dP) \cap |AB| = \{R\}$$

$\Rightarrow$  points A and B are on different sides of (dP).

Solution to [Problem 143](#).

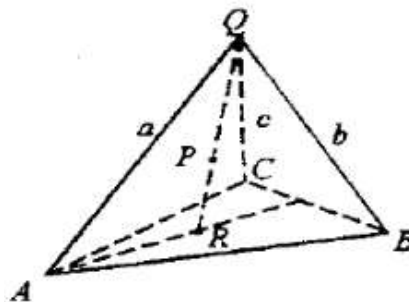

Let rays  $\alpha' = |OA_1B$ ,  $\beta = |OA_1C$ ,  $\gamma' = |OA_1P$ .

As  $P$  is interior to the dihedron formed by any half-plane passing through  $O$  of the trihedral, so

$$\left. \begin{array}{l} P \in \text{int } \widehat{\alpha'\beta'} \\ B \in \alpha' \\ C \in \gamma \end{array} \right\} \Rightarrow |BC| \cap \gamma' = \{Q\}$$

So

$$\left. \begin{array}{l} P \in |OA_1P \\ Q \in |OA_1P = \gamma' \end{array} \right\} \Rightarrow$$

$P$  and  $Q$  in the same half-plane det.  $OA \Rightarrow P$  and  $Q$  on the same side of  $OA$  (1)

$$P \in \text{int } \widehat{abc} \Rightarrow P \in |OAC, A \Rightarrow$$

$\Rightarrow P$  and  $A$  are on the same side of  $(OBC) \cap \gamma' \Rightarrow P$  and  $A$  are on the same side of  $OQ$  (2).

From (1) and (2)  $\Rightarrow$

$$P \in \text{int } \widehat{AOQ} \stackrel{\text{T. transv.}}{\Rightarrow} |AQ| \cap |OP| = \{R\} \Rightarrow R \in |AQ|, |AQ| \subset \text{int } .ABC$$

$$\Rightarrow R \in \text{int } .ABC \Rightarrow |OP| \cap \text{int } .ABC = \{R\}.$$

Solution to [Problem 144](#).

Let  $M$  and  $M'$  be two convex sets and  $M \cap M'$  their intersection. Let

$$\Rightarrow \left. \begin{array}{l} PQ \in M \cap M', P \neq Q \Rightarrow P \in M \cap Q \in M \\ P \in M' \cap Q \in M' \end{array} \right\} \stackrel{M, M' \text{ convex}}{\Rightarrow} \left\{ \begin{array}{l} |PQ| \subset M \\ |PQ| \subset M' \end{array} \right. \Rightarrow$$

$$\Rightarrow |PQ| \subset M \cap M'$$

so the intersection is convex.

Solution to [Problem 145](#).

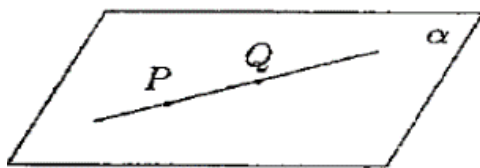

a. Let  $P, Q \in \alpha$ ;  $P \neq Q \Rightarrow |PQ| = PQ$  (the line is a convex set)

$PQ \subset \alpha$ , so  $|PQ| \subset \alpha$ , so the plane is a convex set.

- b. Half-planes: Let  $S = |dA$  and  $P, Q \in S \Rightarrow |PQ| \cap d = \emptyset$ . Let  $M \in |PQ| \Rightarrow |PM| \subset |PQ| \Rightarrow |PM| \cap d = \emptyset \Rightarrow P$  and  $M$  are in the same half-plane  $\Rightarrow M \in S$ . So  $|PQ| \subset S$  and  $S$  is a convex set.

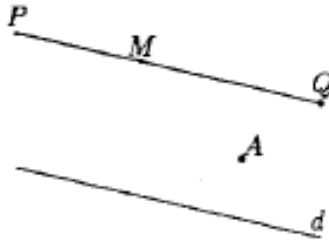

Let  $S' = [dA$ . There are three situations:

- 1)  $P, Q \in |dA$  – previously discussed;
- 2)  $P, Q \in d \Rightarrow |PQ| \subset d \subset S'$ ;
- 3)  $P \in d, Q \notin d \Rightarrow |PQ| \subset |dQ| \Rightarrow |PQ| \subset |dA \subset [dA$  so  $[dA$  is a convex set.

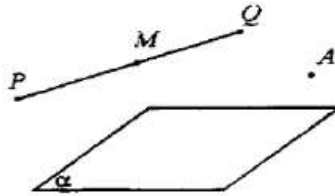

- c. Half-spaces: Let  $\sigma = |\alpha A$  and let  $P, Q \in \sigma \Rightarrow |PQ| \cap \alpha = \emptyset$ .

Let  $M \in |PQ| \Rightarrow |PM| \subset |PQ| \Rightarrow |PM| \cap \alpha = \emptyset$ .

Let  $\sigma' = [\alpha A$ . There are three situations:

- 1)  $P, Q \in |\alpha A$  previously discussed;
- 2)  $P, Q \in \alpha \Rightarrow |PQ| \subset \alpha \subset \sigma'$ ;
- 3)  $P \in \alpha, Q \notin \alpha$ .

$$P, Q \in \sigma' \Rightarrow [PQ] \subset \sigma' \Rightarrow [PQ] \subset \sigma'$$

and so  $\sigma'$  is a convex set.

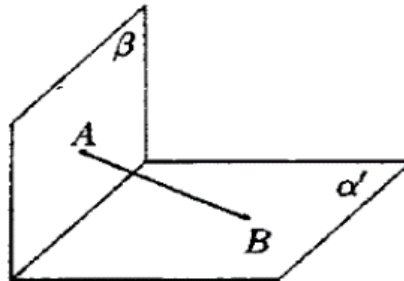

- d. the interior of a dihedral angle:

$int.\alpha'\beta' = |\alpha A \cap |\beta B$  and as each half-space is a convex set and their intersection is the convex set.

Solution to [Problem 146](#).

No. The dihedral angle is not a convex set, because if we consider it as in the previous figure  $A \in \beta'$  and  $B \in \alpha'$ .

$$\left. \begin{aligned} (\forall) P \in \text{int.} \widehat{\alpha'\beta'}, |dP \cap |AB| \neq \emptyset \\ \Rightarrow (\exists) M \in |AB| \text{ a. i. } M \in \text{int.} \widehat{\alpha'\beta'} \\ M \notin \alpha', M \notin \beta' \end{aligned} \right\} \Rightarrow |AB| \notin \widehat{\alpha'\beta'}.$$

Only in the case of the null or straight angle, when the dihedral angle becomes a plane or closed half-plane, is a convex set.

Solution to [Problem 147](#).

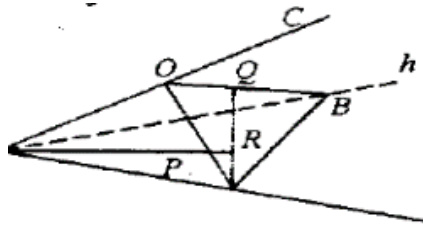

a. No. The trihedral angle is not the convex set, because, if we take  $A \in a$  and  $Q \in$  the int.  $\widehat{bc}$  determined by  $P \in$  the int.  $\widehat{abc}$ ,  $(\exists) R$  such that  $|OP \cap$  the int.  $ABC = \{R\}$ ,  $R \in |AQ|$ ,  $R \notin \widehat{abc}$ .

So  $A, Q \in \widehat{abc}$ , but  $|AQ| \notin abc$ .

b.  $B = (OCA)$ ,  $\gamma = (OAB)$  is a convex set as an intersection of convex sets.

c. It is the same set from a. and it is not convex.

d. The respective set is  $[\alpha A \cap \beta B \cap \gamma C]$ , intersection of convex sets and, thus, it is convex.

Solution to [Problem 148](#).

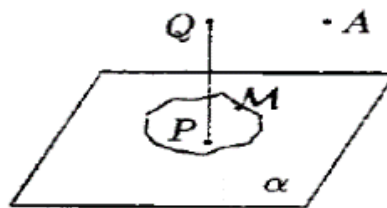

Let  $\sigma = | \alpha A$  and  $M \subset \alpha$ . Let  $P, Q \in M \cap \sigma$ .

We have the following situations:

- a)  $P, Q \in \sigma \Rightarrow |PQ| \subset \sigma \subset \mathcal{M}$ ;  
 b)  $P, Q \in \mathcal{M} \Rightarrow |PQ| \subset \mathcal{M} \subset \sigma \cap \mathcal{M}$ ;  
 c)  $P \in \mathcal{M}, Q \in \sigma \Rightarrow |PQ| \subset \sigma \subset \sigma \cap \mathcal{M}$ .

Solution to [Problem 149](#).

$$S(O, r) = \{M \in S \mid \|OM\| = r\}.$$

$$S(O, r) \cap \alpha = \{M \in S \mid M \in S(O, r) \cap \alpha \mid \|OM\| = r\} = \{M \in \alpha \mid \|OM\| = r\} = C(O, r)$$

Solution to [Problem 150](#).

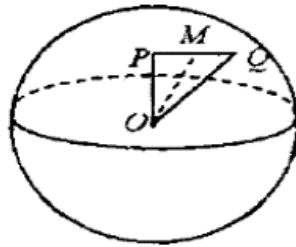

Let

$$P, Q \in \text{int.}S(O, r) \Rightarrow \|OP\| < r, \|OQ\| < r.$$

In plane  $(OPQ)$ , let  $M \in (PQ)$ .

$$\left. \begin{array}{l} \Rightarrow \|OM\| < \|OP\| < r \\ \text{or} \\ \|OM\| < \|OQ\| < r \end{array} \right\} \Rightarrow \|OM\| < r$$

$$\Rightarrow M \in S(O, r) (\forall) M \in |PQ| \Rightarrow |PQ| \subset S(O, r)$$

Solution to [Problem 151](#).

- Let:
- $P$  midpoint of  $|AB|$
  - $R$  midpoint of  $|BC|$
  - $Q$  midpoint of  $|DC|$
  - $S$  midpoint of  $|AD|$
  - $T$  midpoint of  $|BD|$
  - $U$  midpoint of  $|AC|$

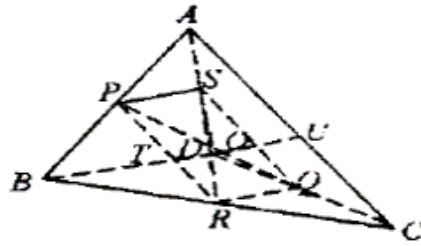

In triangle ABC:

$$|RP| \text{ l.m. } \|PR\| = \frac{\|AC\|}{2}; PR \parallel AC.$$

In triangle DAC:

$$|SQ| \text{ l.m. } \|SQ\| = \frac{\|AC\|}{2}; SQ \parallel AC.$$

$$\Rightarrow \|PR\| = \|SQ\|, PR \parallel SQ \Rightarrow PRSQ$$

$\Rightarrow$  parallelogram  $\Rightarrow |PQ|$  and  $|SR|$  intersect at their midpoint  $O$ .

$$\left. \begin{array}{l} \|ST\| = \frac{\|AB\|}{2}, \quad \|OR\| = \frac{\|AB\|}{2} \\ ST \parallel AB \quad UR \parallel AB \end{array} \right\} \Rightarrow \left. \begin{array}{l} \|ST\| = \|UR\| \\ ST \parallel UR \end{array} \right\} \Rightarrow$$

$\Rightarrow STRU$  parallelogram.

$\Rightarrow |TU|$  passes through midpoint  $O$  of  $|SR|$ .

Thus the three lines  $PR, SR, TU$  are concurrent in  $O$ .

Solution to [Problem 152](#).

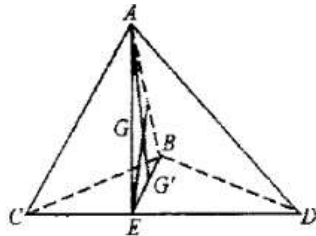

Let tetrahedron  $ABCD$  and  $E$  be the midpoint of  $|CD|$ . The centroid  $G$  of the face  $ACD$  is on  $|AE|$  at a third from the base. The centroid  $G'$  of the face  $BCD$  is on  $|BE|$  at a third from the base  $|CD|$ .

We separately consider  $\Delta AEB$ . Let  $F$  be the midpoint of  $AB$ , so  $EF$  is median in this triangle and, in the previous problem, it was one of the 3 concurrent segments in a point located in the middle of each.

Let  $O$  be the midpoint of  $|EF|$ . We write  $AO \cap EB = \{G\}$  and  $BG \cap EA = \{G\}$ .

$$|AF| \equiv |FB| \Rightarrow |FH| \text{ m. in } \Delta ABG' \Rightarrow |BH| \equiv |HG'| \quad (1)$$

$$\left. \begin{array}{l} OG' \parallel FH \\ |EO| \equiv |OF| \end{array} \right\} \Rightarrow |OG'| \text{ l.m. in } \Delta EFH \Rightarrow |EG'| \equiv G'H \quad (2)$$

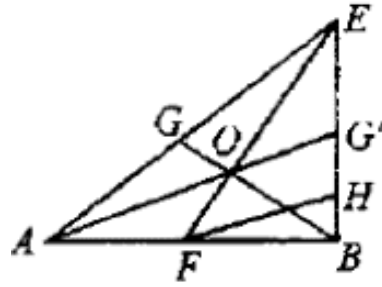

From (1) and (2)

$$\Rightarrow |EG'| \equiv |G'H| \equiv |HB| \Rightarrow \frac{|EG'|}{|EB|} = \frac{1}{3} \Rightarrow$$

$\Rightarrow G'$  is exactly the centroid of face  $BCD$ , because it is situated on median  $|EB|$  at a third from  $E$ . We show in the same way that  $G$  is exactly the centroid of face  $ACD$ . We've thus shown that  $BG$  and  $AG'$  pass through point  $O$  from the previous problem.

We choose faces  $ACD$  and  $ACB$  and mark by  $G''$  the centroid of face  $ACB$ , we show in the same way that  $BG$  and  $DG''$  pass through the middle of the segment  $|MN|$  ( $|AM| \equiv |MC|, |BN| \equiv |ND|$ ) thus also through point  $O$ , etc.

Solution to [Problem 153](#).

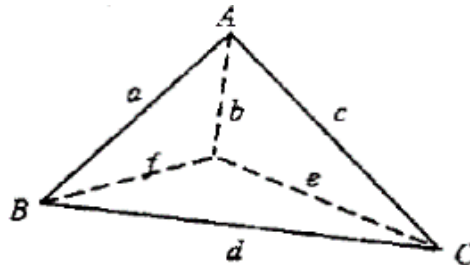

We mark planes  $(ABC) = \alpha, (ADC) = \beta, (BDC) = \gamma, (ABO) = \delta$ .

Let  $M$  be the intersection of the interiors of the 4 trihedral angles.

We show that:

$M = \text{int.}[ABCD]$ , by double inclusion.

1.  $P \in M \Rightarrow P \in \text{int.} \widehat{abc} \cap \text{int.} \widehat{afd} \cap \text{int.} \widehat{dec} \cap \text{int.} \widehat{bfc} \Rightarrow P \in |\alpha D \cap |\gamma C \cap |\beta B$  and  $P \in |\delta A \cap |\gamma C \cap |\beta B \Rightarrow P \in |\alpha D$  and  $P \in |\beta B$  and  $P \in |\gamma C$  and  $P \in |\delta C \Rightarrow P \in |\alpha D \cap |\gamma C \cap |\beta B \cap \delta A \Rightarrow P \in \text{int.}[ABCD]$ . So  $M \in [ABCD]$ .
2. Following the inverse reasoning we show that  $[ABCD] \subset M$  from where the equality.



Solution to [Problem 154](#).

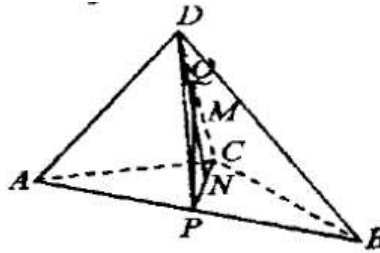

$$M \in \text{int.}[ABCD] \Rightarrow (\exists)N \in \text{int. } ABC$$

such that

$$M \in |DN|, N \in \text{int.}ABC \Rightarrow (\exists)P \in |AB|$$

such that  $N \in |CP|, (ADB) \cap (DPC) = DP$ .

From  $N \in |CP|$  and  $\in |DN| \xrightarrow{\text{lemma}} \text{int.}DPC \Rightarrow M \in \text{int.}DPC \Rightarrow (\exists)Q \in |DC|$ .

So we showed that  $(\exists)P \in |AB|$  and  $Q \in |DC|$  such that  $M \in |PQ|$ .

Solution to [Problem 155](#).

Let  $\mathcal{M}$  be the union of the open segments  $|PQ|$ . We must prove that:  $\text{int. } [ABCD] = \mathcal{M}$  through double inclusion.

1. Let  $M \in \text{int.}[ABCD] \Rightarrow (\forall)P \in |AB|$  and  $Q \in |CD|$  such that  $M \in |PQ| \Rightarrow M \in \mathcal{M}$  so  $\text{int. } [ABCD] \subset \mathcal{M}$ .

2. Let  $M \in \mathcal{M} \Rightarrow (\exists)P \in |AB|$  and  $Q \in |CD|$  such that  $M \in |PQ|$ . Points  $D, C$  and  $P$  determine plane  $(PDC)$  and  $(PDC) \cap (ACB) = PC, (PDC) \cap (ADB) = PD$ .

As  $(\forall)Q \in |CD|$  such that  $M \in |PQ| \Rightarrow M \in [PCD] \Rightarrow (\forall)R \in |PC|$  such that  $M \in |DR|$ .

If  $P \in |AB|$  and  $R \in |PC| \Rightarrow R \in \text{int. } ACB$  such that  $M \in |DR| \Rightarrow M \in \text{int.}[ABCD] \Rightarrow \mathcal{M} \subset \text{int.}[ABCD]$ .

Working with closed segments we obtain that  $(\forall)R \in [ACB]$  such that  $M \in [DR]$ , thus obtaining tetrahedron  $[ABCD]$ .

Solution to [Problem 156](#).

Let  $M \in [ABCD] \Rightarrow (\exists)P \in [ABC]$  such that  $M \in [DP]$ .

Let  $N \in [ABCD] \Rightarrow (\exists)Q \in [ABC]$  such that  $N \in [DQ]$ .

The concurrent lines  $DM$  and  $DN$  determine angle  $DMN$ .

The surface of triangle  $DPQ$  is a convex set.

$$\Rightarrow \left. \begin{array}{l} M \in [DPQ] \\ N \in [DPQ] \end{array} \right\} \Rightarrow |MN| \subset [DPQ].$$

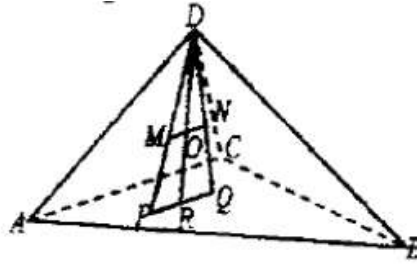

Let

$$O \in |MN| \Rightarrow O \in [DPQ] \Rightarrow (\exists)R \in [PQ]$$

such that  $O \in [DR]$ . But  $[PQ] \subset [ABC]$  because  $P \in [ABC] \cap Q \in [ABC]$  and the surface of the triangle is convex. So  $(\exists)R \in [ABC]$  such that

$$O \in [DR] \Rightarrow O \in [ABCD], (\forall)O \in |MN| \Rightarrow |MN| \subset [ABCD]$$

and the tetrahedron is a convex set.

*Note:* The tetrahedron can be regarded as the intersection of four closed half-spaces which are convex sets.

### Solution to [Problem 157](#).

Let  $\mathcal{M}$  be the union of the segments  $[PQ]$  with  $P \in \mathcal{M}_1$  and  $Q \in \mathcal{M}_2$ .

Let  $x, x' \in \mathcal{M} \Rightarrow (\forall)P \in \mathcal{M}_1$  and  $Q \in \mathcal{M}_2$  such that  $x \in [PQ]$ ;

$(\exists)P' \in \mathcal{M}_1$  and  $Q' \in \mathcal{M}_2$  such that  $x' \in [P'Q']$ .

From  $P, P' \in \mathcal{M}_1 \Rightarrow [PP'] \in \mathcal{M}_1$  which is a convex set.

From  $Q, Q' \in \mathcal{M}_2 \Rightarrow [QQ'] \in \mathcal{M}_2$  which is a convex set.

The union of all the segments  $[MN]$  with  $M \in [PP']$  and  $N \in [QQ']$  is tetrahedron  $[PP'QQ'] \subset \mathcal{M}$ .

So from  $x, x' \in \mathcal{M} \Rightarrow |xx'| \subset \mathcal{M}$ , so set  $\mathcal{M}$  is convex.

### Solution to [Problem 158](#).

The interior of the tetrahedron coincides with the union of segments  $|PQ|, P \in |AB|$  and  $Q \in |CD|$ , that is  $\text{int.}[ABCD] = \{|PQ| \mid P \in |AB|, Q \in |CD|\}$ .

Let's show that:

$$\text{int.}[ABCD] = |(ABC), D \cap |(ABD), C \cap |(ADC), B \cap \cap |(DBC), A.$$

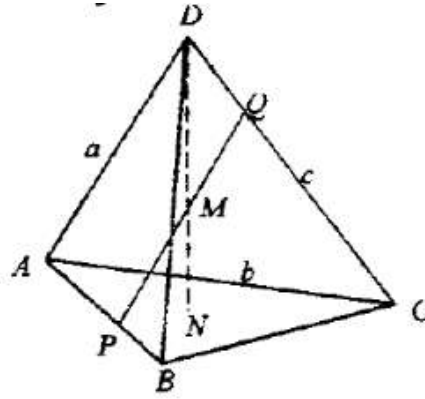

1. Let

$$M \in \text{int.}[ABCD] \Rightarrow P \in |AB| \mid Q \in |DC| \mid M \in |PQ|.$$

$$P \in |AB| \Rightarrow B \notin |AP| \Rightarrow |AP| \cap (BDC) = \emptyset \Rightarrow \left. \begin{array}{l} P \in |(BDC), A \\ P \in (BDC) \end{array} \right\} \Rightarrow$$

$$\Rightarrow |PQ| \subset |(BDC), A; M \in |PQ| \Rightarrow M \in |(BDC), A \quad (1)$$

$$P \in |AB| \Rightarrow A \notin |PB| \Rightarrow |PB| \cap (ADC) = \emptyset \Rightarrow P \in |(ADC), B; Q \in (ADC) \Rightarrow$$

$$\Rightarrow |PQ| \subset |(ADC), B \Rightarrow M \in |(ADC), B \quad (2)$$

$$Q \in |DC| \Rightarrow D \notin |QC| \Rightarrow |QC| \cap (ABD) = \emptyset \Rightarrow \left. \begin{array}{l} Q \in |(ABD), C \\ P \in (ABD) \end{array} \right\} \Rightarrow$$

$$\Rightarrow |PQ| \subset |(ABD), C \Rightarrow M \in |(ABD), C \quad (3)$$

$$Q \in |DC| \Rightarrow C \notin |DQ| \Rightarrow |DQ| \cap (ABC) = \emptyset \Rightarrow \left. \begin{array}{l} Q \in |(ABC), D \\ P \in (ABC) \end{array} \right\} \Rightarrow$$

$$\Rightarrow |PQ| \subset |(ABC), D \Rightarrow M \in |(ABC), D \quad (4)$$

$$(1),(2),(3),(4) \Rightarrow M \in |(BDC), A \cap |(ADC), B \cap |(ABD), C \cap |(ABC), D$$

$$\text{int.}[ABCD] \subset |(BDC), A \cap |(ADC), B \cap |(ABD), C \cap |(ABC), D.$$

2. Let

$$M \in |(BDC), A \cap |(ADC), B \cap |(ABD), C \cap |(ABC), D \Rightarrow M \in |(BDC), A \cap |(ADC),$$

$$B \cap |(ABD), C \Rightarrow M \in \text{int.} \widehat{abc} \Rightarrow |DM| \cap \text{int.}ABC = \{N\}.$$

If we assume  $N \in |DM| \Rightarrow |DM| \cap (ABC) \neq \emptyset \Rightarrow M$  and  $D$  are in different half-spaces in relation to  $(ABC) \Rightarrow M \notin (ABC), D$ , false (it contradicts the hypothesis).

So

$$M \in |DN|, (\exists) N \in \text{int.}ABC \text{ a.i. } M \in |DN| \Rightarrow M \in \text{int.} [ABCD]$$

and the second inclusion is proved.

As regarding the tetrahedron:  $[ABCD] = \{|PQ| \setminus P \in [AB] \text{ and } Q \in [CD]\}$ .

$P = A, Q \in [CD], [PQ]$  describes face  $[ADC]$

If  $P = B, Q \in [CD], [PQ]$  describes face  $[BDC]$

$Q = C, P \in [AB], [PQ]$  describes face  $[ABC]$ .

Because the triangular surfaces are convex sets and along with their two points  $P, Q$ , segment  $[PQ]$  is included in the respective surface.

So, if we add these two situations to the equality from the previous case, we obtain:

$$[ABCD] = [(BCD), A \cap [(ACD), B \cap [(ABD), C \cap [(ABC), D].$$

## Lines and Planes

159. Let  $d, d'$  be two parallel lines. If the line  $d$  is parallel to a plane  $\alpha$ , show that  $d' \parallel \alpha$  or  $d' \subset \alpha$ .

[Solution to Problem 159](#)

160. Consider a line  $d$ , parallel to the planes  $\alpha$  and  $\beta$ , which intersects after the line  $a$ . Show that  $d \parallel a$ .

[Solution to Problem 160](#)

161. Through a given line  $d$ , draw a parallel plane with another given line  $d'$ . Discuss the number of solutions.

[Solution to Problem 161](#)

162. Determine the union of the lines intersecting a given line  $d$  and parallel to another given line  $d'$  ( $d \nparallel d'$ ).

[Solution to Problem 162](#)

163. Construct a line that meets two given lines and that is parallel to a third given line. Discuss.

[Solution to Problem 163](#)

164. If a plane  $\alpha$  intersects the secant planes after parallel lines, then  $\alpha$  is parallel to line  $\beta \cap \gamma$ .

[Solution to Problem 164](#)

165. A variable plane cuts two parallel lines in points  $M$  and  $N$ . Find the geometrical locus of the middle of segment  $[MN]$ .

[Solution to Problem 165](#)

166. Two lines are given. Through a given point, draw a parallel plane with both lines. Discuss.

[Solution to Problem 166](#)

167. Construct a line passing through a given point, which is parallel to a given plane and intersects a given line. Discuss.

[Solution to Problem 167](#)

168. Show that if triangles  $ABC$  and  $A'B'C'$ , located in different planes, have  $AB \parallel A'B'$ ,  $AC \parallel A'C'$  and  $BC \parallel B'C'$ , then lines  $AA'$ ,  $BB'$ ,  $CC'$  are concurrent or parallel.

[Solution to Problem 168](#)

169. Show that, if two planes are parallel, then a plane intersecting one of them after a line cuts the other one too.

[Solution to Problem 169](#)

170. Through the parallel lines  $d$  and  $d'$  we draw the planes  $\alpha$  and  $\alpha'$  distinct from  $(d, d')$ . Show that  $\alpha \parallel \alpha'$  or  $(\alpha \cap \alpha') \parallel d$ .

[Solution to Problem 170](#)

171. Given a plane  $\alpha$ , a point  $A \in \alpha$  and a line  $d \subset \alpha$ .

- Construct a line  $d'$  such that  $d' \subset \alpha$ ,  $A \in d'$  and  $d' \parallel d$ .
- Construct a line through  $A$  included in  $\alpha$ , which forms with  $d$  an angle of a given measure  $a$ . How many solutions are there?

[Solution to Problem 171](#)

172. Show that relation  $\alpha \parallel \beta$  defined on the set of planes is an equivalence relation. Define the equivalence classes.

[Solution to Problem 172](#)

173. Consider on the set of all lines and planes the relation " $x \parallel y$ " or  $x = y$ , where  $x$  and  $y$  are lines or planes. Have we defined an equivalence relation?

[Solution to Problem 173](#)

174. Show that two parallel segments between parallel planes are concurrent.

[Solution to Problem 174](#)

175. Show that through two lines that are not contained in the same plane, we can draw parallel planes in a unique way. Study also the situation when the two lines are coplanar.

[Solution to Problem 175](#)

176. Let  $\alpha$  and  $\beta$  be two parallel planes,  $A, B \in \alpha$ , and  $CD$  is a parallel line with  $\alpha$  and  $\beta$ . Lines  $CA, CB, DB, DA$  cut plane  $\beta$  respectively in  $M, N, P, Q$ . Show that these points are the vertices of a parallelogram.

[Solution to Problem 176](#)

177. Find the locus of the midpoints of the segments that have their extremities in two parallel planes.

[Solution to Problem 177](#)

## Solutions

Solution to [Problem 159](#).

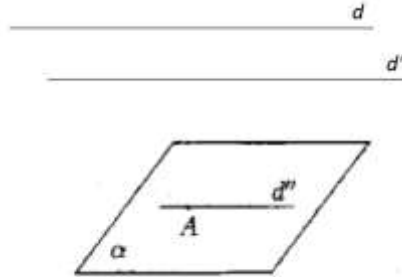

$$\text{Let } \left. \begin{array}{l} A \in \alpha \\ d \parallel \alpha \\ d'' \parallel d \end{array} \right\} \Rightarrow d'' \parallel \alpha \left. \vphantom{\begin{array}{l} A \in \alpha \\ d \parallel \alpha \\ d'' \parallel d \end{array}} \right\} \Rightarrow d'' \parallel \alpha \text{ or } d' \subset \alpha.$$

$$\left. \begin{array}{l} d' \parallel d \\ d'' \parallel d \end{array} \right\} \Rightarrow d' \parallel d''$$

Solution to [Problem 160](#).

Let  $A \in a \Rightarrow A \in \alpha \cap A \in \beta$ . We draw through A,  $d' \parallel d$ .

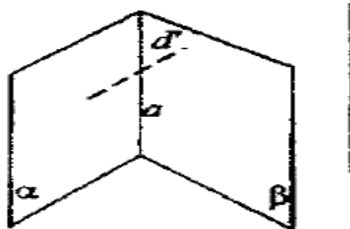

$$\left. \begin{array}{l} A \in \alpha, d \parallel \alpha \\ d' \parallel d \end{array} \right\} \Rightarrow d' \subset \alpha \left. \vphantom{\begin{array}{l} A \in \alpha, d \parallel \alpha \\ d' \parallel d \end{array}} \right\} \Rightarrow d' \subset \alpha \subset \beta \left. \vphantom{\begin{array}{l} A \in \alpha, d \parallel \alpha \\ d' \parallel d \end{array}} \right\} \Rightarrow d' = a \left. \vphantom{\begin{array}{l} A \in \alpha, d \parallel \alpha \\ d' \parallel d \end{array}} \right\} \Rightarrow a \parallel d$$

$$\left. \begin{array}{l} A \in \beta, d \parallel \beta \\ d' \parallel d \end{array} \right\} \Rightarrow d' \subset \beta \left. \vphantom{\begin{array}{l} A \in \beta, d \parallel \beta \\ d' \parallel d \end{array}} \right\} \Rightarrow \alpha \cap \beta = a \left. \vphantom{\begin{array}{l} A \in \beta, d \parallel \beta \\ d' \parallel d \end{array}} \right\} \Rightarrow d' \parallel d \left. \vphantom{\begin{array}{l} A \in \beta, d \parallel \beta \\ d' \parallel d \end{array}} \right\} \Rightarrow a \parallel d$$

Solution to [Problem 161](#).

a. If  $d \nparallel d'$  there is only one solution and it can be obtained as it follows:

Let  $A \in d$ . In the plane  $(A, d')$  we draw  $d'' \parallel d'$ . The concurrent lines  $d$  and  $d''$  determine plane  $a$ . As  $d'' \parallel d \Rightarrow d \parallel \alpha$ , in the case of the non-coplanar lines.



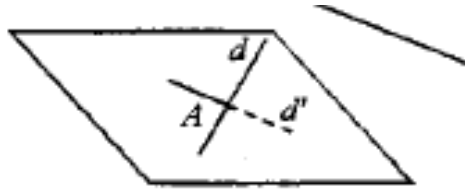

b. If  $d \parallel d' \parallel d''$ ,  $(\exists)$  infinite solutions. Any plane passing through  $d$  is parallel to  $d''$ , with the exception of plane  $(d, d')$ .

c.  $d \nparallel d'$ , but they are coplanar  $(\nexists)$  solutions.

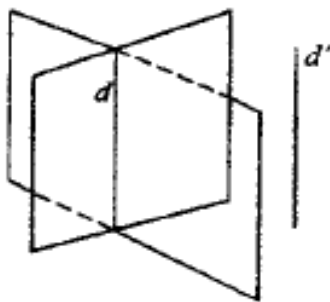

Solution to [Problem 162](#).

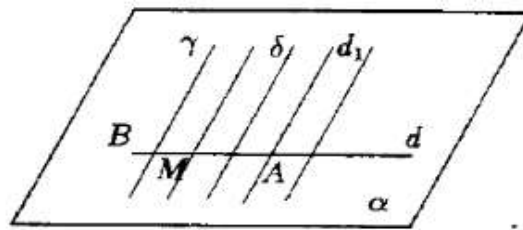

Let  $A \in d$ , we draw through  $A, d_1 \parallel d'$ . We write  $\alpha = (d, d_1)$ . As  $d_1 \parallel d' \Rightarrow d' \parallel \alpha$ .

Let  $M \in d$ , arbitrary  $\Rightarrow M \in \alpha$ .

We draw  $\left. \begin{array}{l} \delta \parallel d', M \in \delta \\ d' \parallel \alpha \end{array} \right\} \Rightarrow \delta \subset \alpha$ , so all the parallel lines to  $d'$  intersecting  $d$  are contained in plane  $\alpha$ .

Let  $\gamma \subset \alpha, \gamma \parallel d' \Rightarrow \gamma \cap d = B$ , so  $(\forall)$  parallel to  $d'$  from  $\alpha$  intersects  $d$ . Thus, the plane  $\alpha$  represents the required union.

Solution to [Problem 163](#).

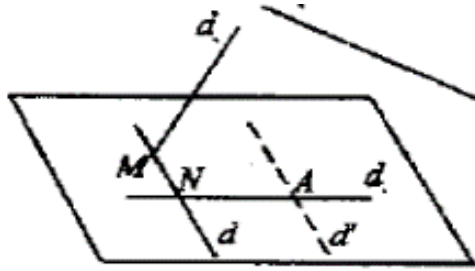

We draw  $d$  through  $M$  such that  $\left. \begin{matrix} d \parallel d' \\ d' \parallel d_3 \end{matrix} \right\} \Rightarrow d \parallel d_3$ . According to previous problem:  $d \cap d_1 = \{N\}$ . Therefore,

$$d \cap d_2 = \{M\}$$

$$d \cap d_1 = \{N\}$$

$$d \parallel d_3$$

- If  $d_3 \parallel d_1$ , the plane  $\alpha$  is unique, and if  $d_2 \cap \alpha \neq \emptyset$ , the solution is unique.
- If  $d_1 \parallel d_3$ ,  $(\nexists) d \parallel d_1$ , because it would mean that we can draw through a point two parallel lines  $d, d_1$  to the same line  $d_3$ . So there is no solution.
- If  $d_1 \nparallel d_3$  and  $d_2 \cap \alpha \neq \emptyset$ , all the parallel lines to  $d_2$  cutting  $d_1$  are on the plane  $\alpha$  and none of them can intersect  $d_2$ , so the problem has no solution.
- If  $d_2 \subset \alpha$ ,  $d_1 \cap d_2 \neq \emptyset$ , let  $d_1 \cap d_2 = \{O\}$ , and the required line is parallel to  $d_3$  drawn through  $O \Rightarrow$  one solution.

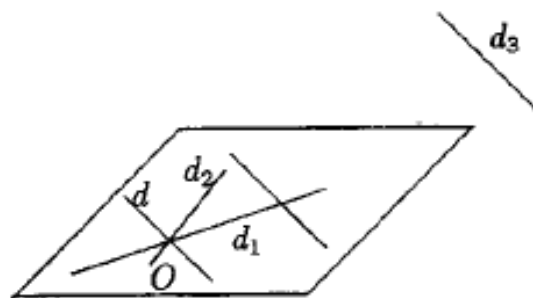

- If  $d_2 \subset \alpha$ ,  $d_1 \parallel d_2$ . The problem has infinite solutions,  $(\forall) \parallel$  to  $d_3$  which cuts  $d_1$ , also cuts  $d_2$ .

Solution to [Problem 164](#).

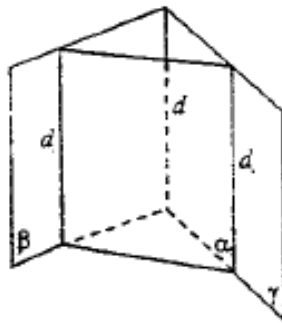

$$\beta \cap \gamma = d$$

$$\alpha \cap \beta = d_1$$

$$\alpha \cap \gamma = d_2$$

$$d_1 \parallel d_2$$

$$\left. \begin{array}{l} d_1 \parallel d_2 \Rightarrow d_1 \parallel \gamma \\ d_1 \subset \beta \end{array} \right\} \Rightarrow \beta \cap \gamma = d$$

$$\left. \begin{array}{l} d = d_1 \\ d_1 \subset \alpha \end{array} \right\} \Rightarrow d \parallel \alpha$$

Solution to [Problem 165](#).

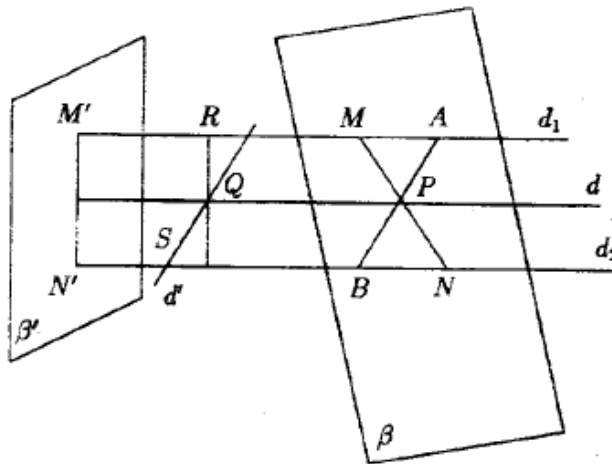

$$d_1 \parallel d_2 \Rightarrow (\exists) \alpha = (d_1, d_2)$$

The problem is reduced to the geometrical locus of the midpoints of the segments that have extremities on two parallel lines.  $P$  is such a point  $|MP| = |PN|$ . We draw  $AB \perp d_1 \Rightarrow \widehat{MPA} = \widehat{BPN} \Rightarrow \Delta MAP = \Delta NBP \Rightarrow |PA| \equiv |PB| \Rightarrow ||AP|| \Rightarrow$  the geometrical locus is the parallel to  $d_1$  and  $d_2$  drawn on the mid-distance between them. It can also be proved vice-versa.

Solution to [Problem 166](#).

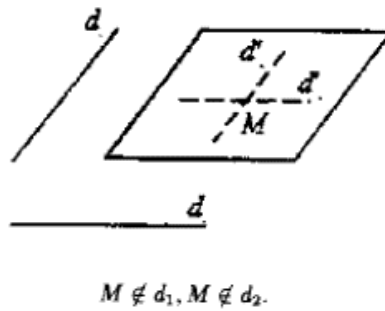

Let  $d_1 \nparallel d_2$ . In plane  $(d, M)$  we draw  $d'_1 \parallel d_1, M \in d'_1$ . In plane  $(d_2M)$  we draw  $d'_2 \parallel d_2, M \in d'_2$ . We note  $\alpha = d'_1d'_2$  the plane determined by two concurrent lines.

$$d_1 \parallel d'_1 \Rightarrow d_1 \parallel \alpha$$

$$d_2 \parallel d'_2 \Rightarrow d_2 \parallel \alpha$$

$M \in \alpha$  the only solution.

Let  $d_1 \parallel d_2, N \notin d_1, M \notin d_2$ .

$$d_1 = d'_1 = d'_2$$

In this case  $d'_1 = d'_2 = d$  and infinite planes pass through  $d$ ;

$$\left. \begin{array}{l} d_2 \parallel d \\ d_1 \parallel d \end{array} \right\} \Rightarrow d_1, d_2 \text{ are parallel lines with } (\forall) \text{ of the planes passing through } d.$$

The problem has infinite solutions. But  $M \in d_1$  or  $M \in d_2$ , the problem has no solution because the plane can't pass through a point of a line and be parallel to that line.

Solution to [Problem 167](#).

Let  $A$  be the given point,  $\alpha$  the given plane and  $d$  the given line.

a. We assume that  $d \nparallel \alpha, d \cap \alpha = \{M\}$ . Let plane  $(dA)$  which has a common point

$$M \text{ with } \alpha \Rightarrow (dA) \cap \alpha = d'$$

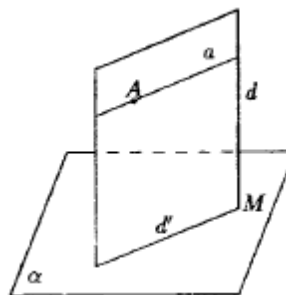

We draw in plane  $(dA)$  through point  $A$  a parallel line to  $d'$ .

$$\left. \begin{array}{l} a \parallel d' \\ d' \cap d = \{M\} \end{array} \right\} \Rightarrow a \cap d \neq \emptyset$$

$$\left. \begin{array}{l} a \parallel d \\ d' \in \alpha \end{array} \right\} \Rightarrow a \parallel \alpha, A \in a$$

$\Rightarrow a$  is the required line.

b.  $d \parallel \alpha, (dA) \cap \alpha \neq \emptyset$ .

$$\text{Let } \left. \begin{array}{l} (dA) \cap \alpha = \alpha' \\ d \parallel \alpha \end{array} \right\} \Rightarrow d' \parallel d$$

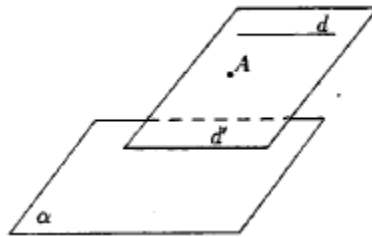

All the lines passing through  $A$  and intersecting  $d$  are contained in plane  $(dA)$ . But all these lines also cut  $d' \parallel d$ , so they can't be parallel to  $\alpha$ . There is no solution.

c.  $d \parallel \alpha, (dA) \cap \alpha = \emptyset$ .

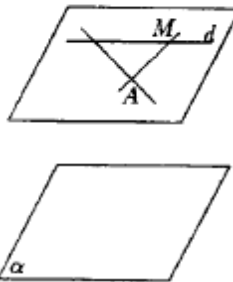

Let  $M \in d$  and line  $AM \subset (dA)$ ;  $(dA) \cap \alpha = \emptyset \Rightarrow AM \cap \alpha = \emptyset \Rightarrow AM \parallel \alpha, (\forall)M \in d$ .

The problem has infinite solutions.

Solution to [Problem 168](#).

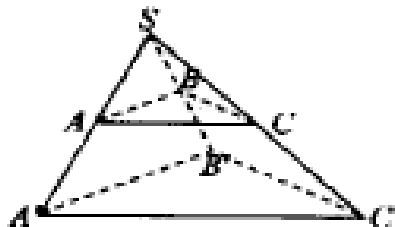

$(ABC)$  and  $(A'B'C')$  are distinct planes, thus the six points  $A, B, C, A', B', C'$  can't be coplanar.

$AB \parallel A'B' \Rightarrow A, B, A', B'$  are coplanar.

The points are coplanar four by four, that is  $(ABB'A)$ ,  $(ACC'A')$ ,  $(BCC'B')$ , and determine four distinct planes. If we assumed that the planes coincide two by two, it would result other 6 coplanar points and this is false.

In plane  $ABB'A'$ , lines  $AA'$ ,  $BB'$  can be parallel or concurrent.

First we assume that:

$$AA' \cap BB' = \{S\} \Rightarrow S \in AA' \cap S \in BB'$$

$$S \in AA' \Rightarrow \left\{ \begin{array}{l} S \in (ABB'A') \\ S \in (ACC'A') \end{array} \right\}$$

$$S \in BB' \Rightarrow \left\{ \begin{array}{l} S \in (BCC'B') \\ S \in (ABB'A') \end{array} \right\}$$

is a common point to the 3 distinct planes, but the intersection of 3 distinct planes can be only a point, a line or  $\emptyset$ . It can't be a line because lines

$$\left. \begin{array}{l} (ABB'A') \cap (ACC'A') = AA' \\ (ABB'A') \cap (BCC'B') = BB' \\ (ACC'A') \cap (BCC'B') = CC' \end{array} \right\}$$

$\Rightarrow$  are distinct if we assumed that two of them coincide, the 6 points would be coplanar, thus there is no common line to all the three planes. There is one possibility left, that is they have a common point  $S$  and from

$$\left. \begin{array}{l} S \in (ACC'A) \\ S \in (CC'BB') \end{array} \right\} \Rightarrow S \in CC' \Rightarrow$$

$$\alpha \parallel \beta \Rightarrow \alpha \cap \beta = \emptyset$$

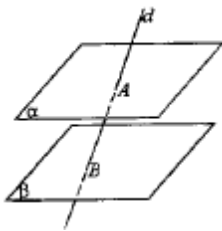

We assume  $d \cap \beta = \emptyset \Rightarrow d \parallel \beta \Rightarrow d \in \text{plane } \parallel \beta \text{ drawn through } A \Rightarrow d \subset \alpha$ , false.

So  $d \cap \beta = \{B\}$ .

Solution to [Problem 169](#).

Hypothesis:  $\alpha \parallel \beta, \gamma \cap \alpha = d_1$ .

Conclusion:  $\gamma \cap \beta = d_2$ .

We assume that  $\gamma \cap \beta = \emptyset \Rightarrow \gamma \parallel \beta$ .

Let

$$A \in d_1 \Rightarrow \left\{ \begin{array}{l} A \in \alpha, \alpha \parallel \beta \\ A \in \gamma, \gamma \parallel \beta \end{array} \right. \Rightarrow \alpha = \gamma$$

because from a point we can draw only one parallel plane with the given plane.  
 But this result is false, it contradicts the hypothesis  $\gamma \cap \alpha = d_1$  so  $\gamma \cap \beta = d_2$ .

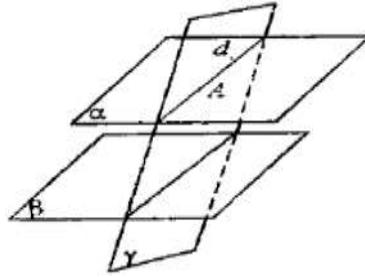

Solution to [Problem 170](#).

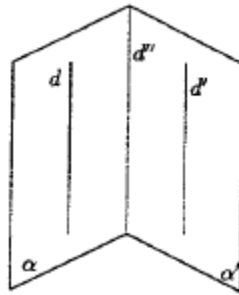

Hypothesis:  $d \parallel d'$ ;  $d \subset \alpha$ ;  $d' \subset \alpha'$ ;  $\alpha, \alpha' \neq (dd')$ .

Conclusion:  $\alpha \parallel \alpha'$  or  $d'' \parallel d$ .

As  $\alpha, \alpha' \neq (dd') \Rightarrow \alpha \neq \alpha'$ .

If  $\alpha \cap \alpha' = \emptyset \Rightarrow \alpha \parallel \alpha'$ .

If  $\alpha \cap \alpha' = \emptyset \Rightarrow \alpha \cap \alpha' = d''$ .

If  $\left. \begin{matrix} d \parallel d'' \\ d' \subset \alpha' \Rightarrow d \parallel \alpha' \\ d \subset \alpha \end{matrix} \right\} \Rightarrow d'' \parallel d$ .

Solution to [Problem 171](#).

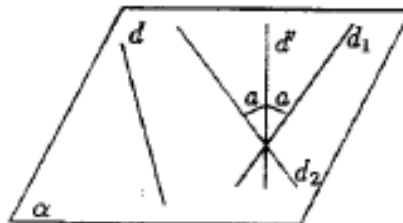

a. If  $A \in d$ , then  $d' = d$ . If  $A \notin d$ , we draw through  $A, d' \parallel d$ .

b. We draw  $d_1 \subset \alpha, A \in d_1$ , such that  $m(\widehat{d_1 d'}) = a$  and  $d \subset \alpha, A \in d$ , such that  $m(\widehat{d_2 d'}) = a$ , a line in each half-plane determined by  $d'$ . So  $(\exists)$  2 solutions excepting the situation  $a = 0$  or  $a = 90$  when  $(\exists)$  only one solution.

Solution to [Problem 172](#).

$$\alpha \parallel \beta \text{ or } \alpha = \beta \Leftrightarrow \alpha \sim \beta$$

1.  $\alpha = \alpha \Rightarrow \alpha \sim \alpha$ , the relation is reflexive;
2.  $\alpha \sim \beta \Rightarrow \beta \sim \alpha$ , the relation is symmetric.  
 $\alpha \parallel \beta \text{ or } \alpha = \beta \Rightarrow \beta \parallel \alpha \text{ or } \beta = \alpha \Rightarrow \beta \sim \alpha$ ;
3.  $\alpha \sim \beta \cap \beta \sim \gamma \Rightarrow \alpha \sim \gamma$ .

$$\text{If } \alpha = \beta \cap \beta \sim \gamma \Rightarrow \alpha \sim \gamma.$$

$$\text{If } \left. \begin{array}{l} \alpha \neq \beta \text{ and } \alpha \sim \beta \Rightarrow \alpha \parallel \beta \\ \beta \sim \gamma \Rightarrow \beta = \gamma \text{ or } \beta \parallel \gamma \end{array} \right\} \Rightarrow \alpha \parallel \gamma \Rightarrow \alpha \sim \gamma.$$

The equivalence class determined by plane  $\alpha$  is constructed of planes  $\alpha'$  with  $\alpha' \sim \alpha$ , that is of  $\alpha$  and all the parallel planes with  $\alpha$ .

Solution to [Problem 173](#).

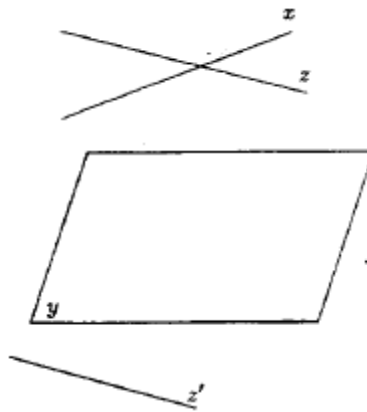

No, it is an equivalence relation, because the transitive property is not true. For example,  $x$  is a line,  $y$  a plane,  $z$  a line. From  $x \parallel y$  and  $y \parallel z \Rightarrow x \parallel z$ , lines  $x$  and  $z$  could be coplanar and concurrent or non-coplanar.



Solution to [Problem 174](#).

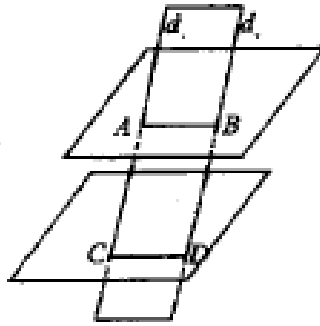

$$d_1 \parallel d_2 \Rightarrow (\exists)\gamma = (d_1 d_2)$$

$$\left. \begin{array}{l} \alpha \cap \gamma = AB \\ \beta \cap \gamma = CD \\ \alpha \parallel \beta \end{array} \right\} \Rightarrow \begin{array}{l} AB \parallel CD \\ AC \parallel BD \end{array} \Rightarrow$$

$\Rightarrow ABCD$  parallelogram.  
 So  $\|AC\| = \|BD\|$ .

Solution to [Problem 175](#).

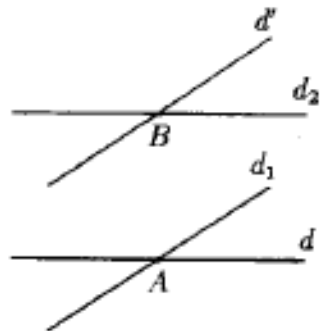

We consider  $A \in d$  and draw through it  $d_1 \parallel d'$ . We consider  $B \in d'$  and draw  $d_2 \parallel d$ . Plane  $(d_1 d_2) \parallel (d d')$ , because two concurrent lines from the first plane are parallel with two concurrent lines from the second plane.

When  $d$  and  $d'$  are coplanar, the four lines  $d, d_1, d_2$  and  $d'$  are coplanar and the two planes coincide with the plane of the lines  $d$  and  $d'$ .

Solution to [Problem 176](#).

Let planes:

$$\left. \begin{array}{l} (CDA) \\ CD \parallel \beta \end{array} \right\} \Rightarrow CD \parallel QM \quad (1)$$

$$\left. \begin{array}{l} (CDB) \\ CD \parallel \beta \end{array} \right\} \Rightarrow CD \parallel PN \quad (2)$$

$$\left. \begin{array}{l} (CAB) \\ \alpha \parallel \beta \end{array} \right\} \Rightarrow AB \parallel MN \quad (3)$$

$$\left. \begin{array}{l} (DAB) \\ \alpha \parallel \beta \end{array} \right\} \Rightarrow AB \parallel QP \quad (4)$$

From (1), (2), (3), (4)  $\Rightarrow MNPQ$  parallelogram.

Solution to [Problem 177](#).

Let  $[AB]$  and  $[CD]$  be two segments, with  $A, C \in \alpha$  and  $B, D \in \beta$  such that  $|AM| = |MB|$  and  $|CN| = |ND|$ .

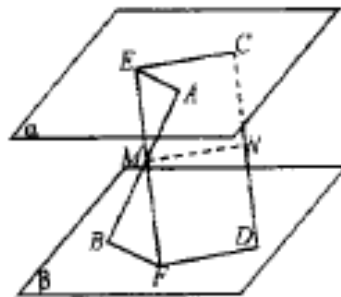

In plane  $(MCD)$  we draw through  $M, EF \parallel CD \Rightarrow EC \parallel DF \Rightarrow EFDC$  parallelogram  
 $\Rightarrow |EF| \equiv |CD|$ .

Concurrent lines  $AB$  and  $EF$  determine a plane which cuts planes  $\alpha$  after 2 parallel lines  $\Rightarrow EA \parallel BF$ .

In this plane,  $|AM| \equiv |BM|$ .

$$\left. \begin{array}{l} \widehat{EMA} \equiv \widehat{BMF} \text{ (angles opposed at peak)} \\ \widehat{EAM} \equiv \widehat{FBM} \text{ (alternate interior angles)} \end{array} \right\}$$

$$\Rightarrow \triangle AME \equiv \triangle BMF \Rightarrow |EM| \equiv |MF|$$

In parallelogram  $ECDF$ ,

$$|CN| \equiv |ND|, |EM| \equiv |MF| \Rightarrow$$

$$\left\{ \begin{array}{l} MN \parallel EC \\ MN \parallel FD \end{array} \right. \Rightarrow \begin{array}{l} MN \parallel \alpha \\ MN \parallel \beta \end{array} \quad (1)$$

So the segment connecting the midpoints of two of the segments with the extremity in  $\alpha$  and  $\beta$  is parallel to these planes. We also consider  $[GH]$  with  $G \in \alpha, H \in \beta$  and  $|GQ| \equiv |QH|$  and we show in the same way that  $OM \parallel \alpha$  and  $OM \parallel \beta$ . (2)

From (1) and (2)  $\Rightarrow M, N, Q$  are elements of a parallel plane to  $\alpha$  and  $\beta$ , marked by  $\gamma$ .

Vice-versa, let's show that any point from this plane is the midpoint of a segment, with its extremities in  $\alpha$  and  $\beta$ .

Let segment  $[AB]$  with  $A \in \alpha$  and  $B \in \beta$  and  $|AM| = |BM|$ . Through  $M$ , we draw the parallel plane with  $\alpha$  and  $\beta$  and in this plane we consider an arbitrary point  $O \in \gamma$ .

Through  $O$  we draw a line such that  $d \cap \alpha = \{I\}$  and  $d \cap \beta = \{I'\}$ .

In plane  $(OAB)$  we draw  $A'B' \parallel AB$ . Plane  $(AA'B'B)$  cuts the three parallel planes after parallel lines  $\Rightarrow$

$$\left. \begin{array}{l} A'A \parallel OM \parallel B'B \\ B \in \beta \end{array} \right\} \Rightarrow$$

In plane  $(A'B'I) \Rightarrow |A'O| \equiv |OB'| \Rightarrow IA' \parallel B'I$  and thus  $\widehat{A'O} \equiv \widehat{OB'}$  and  $\widehat{IA'O} \equiv \widehat{IB'O} \Rightarrow$

$$\Rightarrow \triangle IOA' \equiv \triangle IOB' \Rightarrow |OI| \equiv |IO| \Rightarrow$$

$O$  is the midpoint of a segment with extremities in planes  $\alpha$  and  $\beta$ .

Thus the geometrical locus is plane  $\gamma$ , parallel to  $\alpha$  and  $\beta$  and passing through the mid-distance between  $\alpha$  and  $\beta$ .

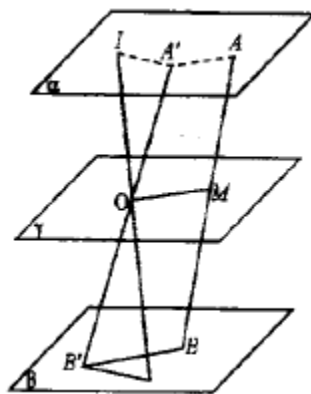

## Projections

178. Show that if lines  $d$  and  $d'$  are parallel, then  $\text{pr}_\alpha d \parallel \text{pr}_\alpha d'$  or  $\text{pr}_\alpha d = \text{pr}_\alpha d'$ .

What can we say about the projective planes of  $d$  and  $d'$ ?

[Solution to Problem 178](#)

179. Show that the projection of a parallelogram on a plane is a parallelogram or a segment.

[Solution to Problem 179](#)

180. Knowing that side  $[OA$  of the right angle  $AOB$  is parallel to a plane  $\alpha$ , show that the projection of  $\widehat{AOB}$  onto the plane  $\alpha$  is a right angle.

[Solution to Problem 180](#)

181. Let  $A'B'C'$  be the projection of  $\Delta ABC$  onto a plane  $\alpha$ . Show that the centroid of  $\Delta ABC$  is projected onto the centroid of  $\Delta A'B'C'$ . Is an analogous result true for the orthocenter?

[Solution to Problem 181](#)

182. Given the non-coplanar points  $A, B, C, D$ , determine a plane on which the points  $A, B, C, D$  are projected onto the peaks of parallelogram.

[Solution to Problem 182](#)

183. Consider all triangles in space that are projected onto a plane  $\alpha$  after the same triangle. Find the locus of the centroid.

[Solution to Problem 183](#)

184. Let  $A$  be a point that is not on line  $d$ . Determine a plane  $\alpha$  such that  $\text{pr}_\alpha d$  passes through  $\text{pr}_\alpha A$ .

[Solution to Problem 184](#)

185. Determine a plane onto which three given lines to be projected after concurrent lines.

[Solution to Problem 185](#)

186. Let  $\alpha, \beta$  be planes that cut each other after a line  $a$  and let  $d$  be a perpendicular line to  $a$ . Show that the projections of line  $d$  onto  $\alpha, \beta$  are concurrent.

[Solution to Problem 186](#)

187. Consider lines  $OA, OB, OC \perp$  two by two. We know that  $\|OA\| = a, \|OB\| = b, \|OC\| = c$ . Find the measure of the angle of planes  $(ABC)$  and  $(OAB)$ .

[Solution to Problem 187](#)

188. A line cuts two perpendicular planes  $\alpha$  and  $\beta$  at  $A$  and  $B$ . Let  $A'$  and  $B'$  be the projections of points  $A$  and  $B$  onto line  $\alpha \cap \beta$ .

- Show that  $\|AB\|^2 = \|AA'\|^2 + \|A'B'\|^2 + \|B'B\|^2$ ;
- If  $a, b, c$  are the measures of the angles of line  $AB$  with planes  $\alpha, \beta$  and with  $\alpha \cap \beta$ , then  $\cos c \frac{\|A'B'\|}{\|AB\|}$  and  $\sin^2 a + \sin^2 b = \sin^2 c$ .

[Solution to Problem 188](#)

189. Let  $ABC$  be a triangle located in a plane  $\alpha, A'B'C'$  the projection of  $\Delta A'B'C'$  onto plane  $\alpha$ . We mark with  $S, S', S''$  the areas of  $\Delta ABC, \Delta A'B'C', \Delta A''B''C''$ , show that  $S'$  is proportional mean between  $S$  and  $S''$ .

[Solution to Problem 189](#)

190. A trihedral  $[ABCD]$  has  $|AC| \equiv |AD| \equiv |BC| \equiv |BD|$ .  $M, N$  are the midpoints of edges  $[AB], [CD]$ , show that:

- $MN \perp AB, MN \perp CD, AB \perp CD$

- b. If  $A', B', C', D'$  are the feet of the perpendicular lines drawn to the peaks  $A, B, C, D$  on the opposite faces of the tetrahedron, points  $B, A', N$  are collinear and so are  $A, B', N$ ;  $D, C', M$ ;  $C, D', M$ .
- c.  $AA', BB', MN$  and  $CC', DD', MN$  are groups of three concurrent lines.

[Solution to Problem 190](#)

191. If rays  $[OA$  and  $[OB$  with their origin in plane  $\alpha$ ,  $OA \perp \alpha$ , then the two rays form an acute or an obtuse angle, depending if they are or are not on the same side of plane  $\alpha$ .

[Solution to Problem 191](#)

192. Show that the 6 mediator planes of the edges of a tetrahedron have a common point. Through this point pass the perpendicular lines to the faces of the tetrahedron, drawn through the centers of the circles of these faces.

[Solution to Problem 192](#)

193. Let  $d$  and  $d'$  be two non-coplanar lines. Show that  $(\exists)$  unique points  $A \in d$ ,  $A' \in d'$  such that  $AA' \perp d$  and  $AA' \perp d'$ . The line  $AA'$  is called the common perpendicular of lines  $d$  and  $d'$ .

[Solution to Problem 193](#)

194. Consider the notations from the previous problem. Let  $M \in d$ ,  $M' \in d'$ . Show that  $\|AA'\| \leq \|MM'\|$ . The equality is possible only if  $M = A$ ,  $M' = A'$ .

[Solution to Problem 194](#)

195. Let  $AA'$  be the common  $\perp$  of non-coplanar lines  $d, d''$  and  $M \in d$ ,  $M' \in d'$  such that  $|AM| \equiv |A'M'|$ . Find the locus of the midpoint of segment  $[MM']$ .

[Solution to Problem 195](#)

196. Consider a tetrahedron  $VABC$  with the following properties.  $ABC$  is an equilateral triangle of side  $a$ ,  $(ABC) \perp (VBC)$ , the planes  $(VAC)$  and  $(VAB)$

form with plane  $(ABC)$  angles of  $60^\circ$ . Find the distance from point  $V$  to plane  $(ABC)$ .

[Solution to Problem 196](#)

197. All the edges of a trihedral are of length  $a$ . Show that a peak is projected onto the opposite face in its centroid. Find the measure of the dihedral angles determined by two faces.

[Solution to Problem 197](#)

198. Let  $DE$  be a perpendicular line to the plane of the square  $ABCD$ . Knowing that  $\|BE\| = l$  and that the measure of the angle formed by  $[BE$  and  $(ABC)$  is  $\beta$ , determine the length of segment  $AE$  and the angle of  $[AE$  with plane  $(ABC)$ .

[Solution to Problem 198](#)

199. Line  $CD \perp$  plane of the equilateral  $\Delta ABC$  of side  $a$ , and  $[AD$  and  $[BD$  form with plane  $(ABC)$  angles of measure  $\beta$ . Find the angle of planes  $(ABC)$  and  $ABD$ .

[Solution to Problem 199](#)

200. Given plane  $\alpha$  and  $\Delta ABC, \Delta A'B'C'$  that are not on this plane. Determine a  $\Delta DEF$ , located on  $\alpha$  such that on one side lines  $AD, BE, CF$  and on the other side lines  $A'D, B'E, C'F$  are concurrent.

[Solution to Problem 200](#)

## Solutions

Solution to [Problem 178](#).

Let  $d \parallel d'$ ,  $\beta$  the projective plane of  $d$ .

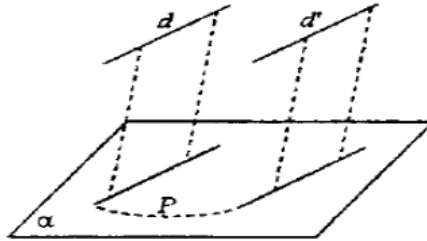

We assume that  $d' \not\subset \beta$ , which means that is plane  $d, d' \perp \alpha, \Rightarrow$  the projective plane of  $d'$  is  $\beta'$ . We want to show that  $\text{pr}_\alpha d \parallel \text{pr}_\alpha d'$ . We assume that  $\text{pr}_\alpha d \cap \text{pr}_\alpha d' = \{P\} \Rightarrow (\exists) M \in d$  such that  $\text{pr}_\alpha M = P$  and  $(\exists) M' \in d'$  such that  $\text{pr}_\alpha M' = P$ .

$\Rightarrow \left. \begin{matrix} PM \perp \alpha \\ PM' \perp \alpha \end{matrix} \right\} \Rightarrow$  in the point  $P$  on plane  $\alpha$  we can draw two distinct perpendicular lines. *False*.

If  $\beta$  is the projective plane of  $d$  and  $\beta'$  of  $d'$ , then  $\beta \parallel \beta'$ , because if they had a common point their projections should be elements of  $\text{pr}_\alpha d$  and  $\text{pr}_\alpha d'$ , and thus they wouldn't be anymore parallel lines.

If  $d' \subset \beta$  or  $d \subset \beta'$ , that is  $(d, d') \perp \alpha \Rightarrow d$  and  $d'$  have the same projective plane  $\Rightarrow \text{pr}_\alpha d = \text{pr}_\alpha d'$ .

Solution to [Problem 179](#).

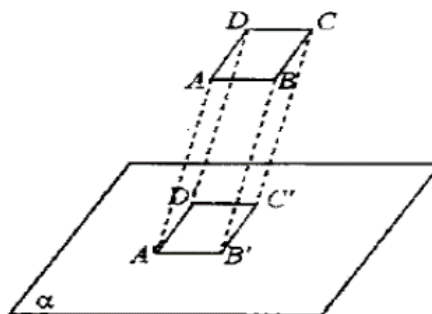



We assume that  $ABCD \perp \alpha$ . Let  $A', B', C', D'$  be the projections of points  $A, B, C, D$ .

$$\left. \begin{array}{l} AB \parallel DC \xrightarrow{pr_1} A'B' \parallel D'C' \\ AD \parallel BC \Rightarrow A'D' \parallel B'D' \end{array} \right\} \Rightarrow A', B', C', D' \text{ parallelogram.}$$

If  $(ABCD) \perp \alpha \Rightarrow$  the projection  $A', B', C', D' \in$  the line  $(ABCD) \cap \alpha \Rightarrow$  the projection of the parallelogram is a segment.

Solution to [Problem 180](#).

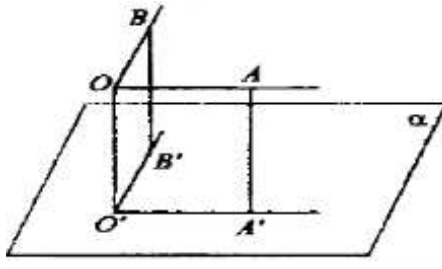

If  $OA \perp \alpha \Rightarrow \text{proj}_\alpha OA \parallel OA \Rightarrow O'A' \parallel OA$  because  $(\forall)$  a plane which passes through  $OA$  cuts the plane  $\alpha$  after a parallel to  $OA$ .

$$\left. \begin{array}{l} OO' \perp O'A' \\ O'A' \parallel OA \end{array} \right\} \Rightarrow \left. \begin{array}{l} OA \perp OO' \\ OA \perp OB \end{array} \right\} \Rightarrow$$

$$\Rightarrow \left. \begin{array}{l} OA \perp (OO'B) \\ O'A' \parallel OA \end{array} \right\} \Rightarrow O'A' \perp (OO'B) \Rightarrow$$

$$\Rightarrow O'A' \perp O'B' \Rightarrow \widehat{A'O'B'} \text{ is a right angle.}$$

Solution to [Problem 181](#).

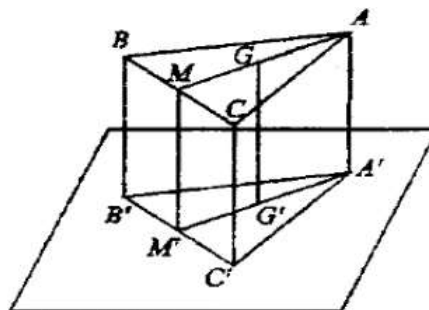

In the trapezoid  $BCC'B'$  ( $BB' \parallel CC'$ ),

$$\left. \begin{array}{l} |BM| \equiv |MC| \\ MM' \parallel BB' \end{array} \right\} \Rightarrow |B'M'| \equiv |MC'|$$

$\Rightarrow A'M'$  is a median.

$$\left. \begin{array}{l} MM' \parallel AA' \Rightarrow MM'A'A \text{ trapezoid} \\ \frac{\|AG\|}{\|GM\|} = 2, GG' \parallel AA' \end{array} \right\} \frac{\|A'G\|}{\|G'M'\|} = \frac{\|AG\|}{\|GM\|} = 2$$

$\Rightarrow G'$  is on median  $A'M'$  at  $2/3$  from the peak and  $1/3$  from the base.

Generally *no*, because the right angle  $AMC$  should be projected after a right angle. The same thing is true for another height. This is achieved if the sides of the  $\Delta$  are parallel to the plane.

Solution to [Problem 182](#).

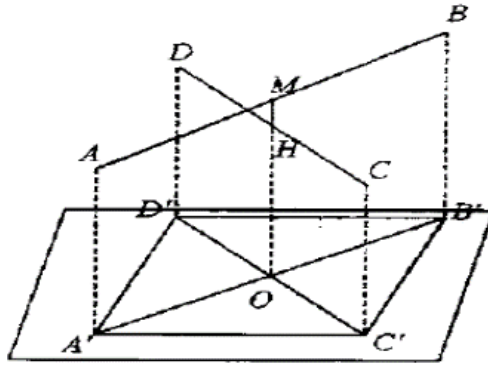

Let  $A, B, C, D$  be the 4 non-coplanar points and  $M, N$  midpoints of segments  $|AB|$  and  $|CD|$ .

$M$  and  $N$  determine a line and let a plane  $\alpha \perp MN$ ,  $M$  and  $N$  are projected in the same point  $O$  onto  $\alpha$ .

$$\left. \begin{array}{l} AA' \parallel MO \parallel BB' \\ |AM| \equiv |MB| \end{array} \right\} \Rightarrow |A'O| \equiv |OB'|$$

$$\left. \begin{array}{l} CC' \parallel DD' \parallel NO \\ |DN| \equiv |NC| \end{array} \right\} \Rightarrow |D'O| \equiv |OC'|$$

$$\left. \begin{array}{l} \Rightarrow |A'O| \equiv |OB'| \\ \Rightarrow |D'O| \equiv |OC'| \end{array} \right\} \Rightarrow$$

$\Rightarrow A'B'C'D'$  a parallelogram.

Solution to [Problem 183](#).

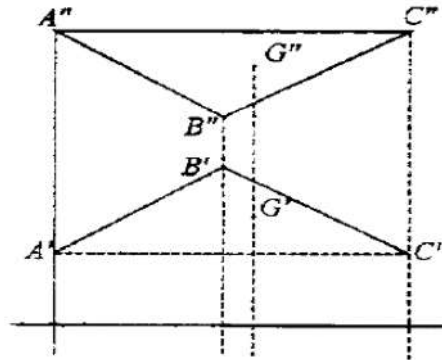

Let  $A'B'C'$ ,  $A''B''C''$  two triangles of this type, with the following property:

$$\text{pr}_\alpha A'B'C' = ABC, \text{pr}_\alpha A''B''C'' = ABC.$$

$$\Rightarrow \left. \begin{array}{l} \text{pr}_\alpha G' = G \Rightarrow G'G \perp \alpha \\ \text{pr}_\alpha G'' = G \Rightarrow G''G \perp \alpha \end{array} \right\} \Rightarrow$$

$$\Rightarrow G'G = GG'' \Rightarrow G'', G', G \text{ are collinear.}$$

Due to the fact that by projection the ratio is maintained, we show that  $G''$  is the centroid of  $A, B, C$ .

$$\frac{\|BG\|}{\|GM\|} = \frac{\|B_1G\|}{\|G_1M_1\|} = 2.$$

Solution to [Problem 184](#).

Let  $M \in d$  and  $A \notin d$ . The two points determine a line and let  $\alpha$  be a perpendicular plane to this line,  $AM \perp \alpha \Rightarrow A$  and  $M$  are projected onto  $\alpha$  in the same point  $A'$  through which also passes  $\text{proj}_\alpha d = \text{proj}_\alpha A \in \text{proj}_\alpha d$ .

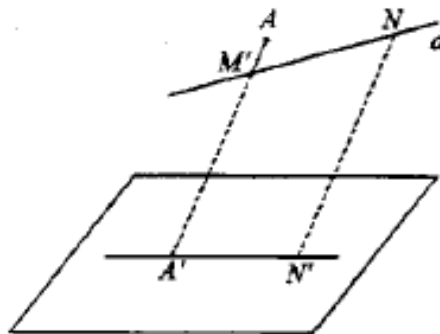

Solution to [Problem 185](#).

We determine a line which meets the three lines in the following way.

Let

$$M \in d_2 \Rightarrow \beta = (M, d_1), \gamma = (M, d_3) \text{ și } \beta \cap \gamma = \\ = d \Rightarrow d \subset \beta_1, d \cap d_1 = \{N\}, d \subset \gamma_1, d \cap d_3 = \{P\}.$$

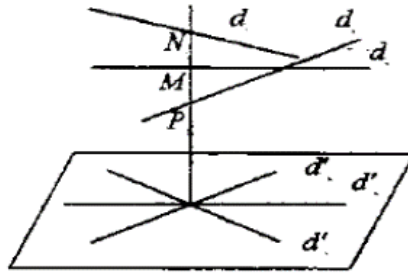

Let now a plane

$$\alpha \perp d \Rightarrow \text{pr}_\alpha M = \text{pr}_\alpha N = \text{pr}_\alpha P = \\ = O \Rightarrow \text{pr}_\alpha d_1 \cap \text{pr}_\alpha d_2 \cap \text{pr}_\alpha d_3 \neq \emptyset \Rightarrow d'_1 \cap d'_2 \cap d'_3 = \\ = \{O\}.$$

Solution to [Problem 186](#).

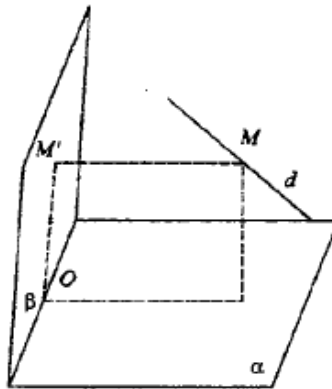

Let  $\alpha \cap \beta = a$  and  $M \in d$ . We project this point onto  $\alpha$  and  $\beta$ :

$$MM' \perp \alpha \Rightarrow \left. \begin{array}{l} MM' \perp a \\ d \perp a \end{array} \right\} \Rightarrow a \perp (MM', d)$$

$$MM'' \perp \beta \Rightarrow \left. \begin{array}{l} MM'' \perp a \\ d \perp a \end{array} \right\} \Rightarrow a \perp (MM'', d)$$

$\Rightarrow a \perp$  onto the projective plane of  $d$  onto  $\beta$ .

$$\left. \begin{array}{l} (MM', d) \perp d \\ (NM'', d) \perp a \end{array} \right\} \Rightarrow (MM', d) \parallel (MM'', d) \Rightarrow$$

$$\Rightarrow (MM', d) = (MM'', d) = (MM'M'')$$

Let

$$a \cap (MM'M'') = \{O\} \Rightarrow \left. \begin{array}{l} \text{pr}_O d = OM' \\ \text{pr}_O d = OM'' \end{array} \right\} \Rightarrow$$

$\Rightarrow OM' \cap OM'' = \{O\}$ , so the two projections are concurrent.

Solution to [Problem 187](#).

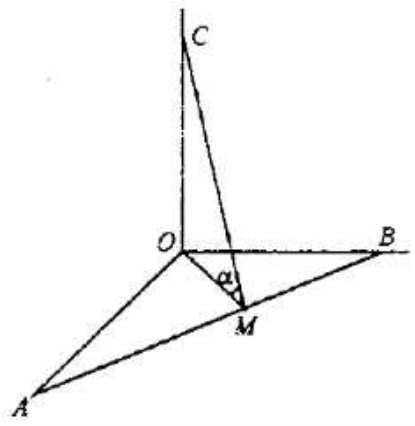

$$\left. \begin{array}{l} OC \perp OA \\ OC \perp OB \end{array} \right\} \Rightarrow \left. \begin{array}{l} OC \perp (OAB) \\ OM \perp AB \end{array} \right\} \Rightarrow CM \perp AB \Rightarrow$$

the angle of planes  $(ABC)$  and  $(OAB)$  is  $\widehat{OMC} = \alpha$ .

$$\|AB\| = \sqrt{a^2 + b^2}; \quad \|OM\| = \frac{ab}{\sqrt{a^2 + b^2}}$$

$$\text{tg } \alpha = \frac{\|OC\|}{\|OM\|} = \frac{c}{\frac{ab}{\sqrt{a^2 + b^2}}} = \frac{c\sqrt{a^2 + b^2}}{ab}.$$

Solution to [Problem 188](#).

Let  $\alpha \cap \beta = a$  and  $AA' \perp a$ ,  $BB' \perp a$ .

$$\left. \begin{array}{l} \alpha \perp \beta \\ A \in \alpha \\ AA' \perp a \end{array} \right\} \Rightarrow AA' \perp \beta \Rightarrow AA' \perp A'B \Rightarrow$$

$$\Rightarrow \|AB\|^2 = \|AA'\|^2 + \|A'B\|^2.$$

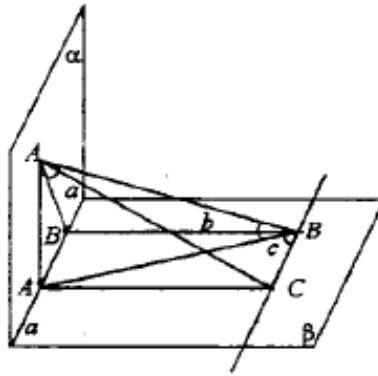

As

$$\left. \begin{array}{l} BB' \perp \alpha \\ \beta \perp \alpha \end{array} \right\} \Rightarrow BB' \perp \alpha \Rightarrow \text{pr}_{\alpha} AB = AB' \Rightarrow$$

$$\Rightarrow \sphericalangle \text{ of line } AB \text{ with } \alpha, \widehat{BAB'} = a$$

$$AA' \perp \beta \Rightarrow \text{pr}_{\beta} AB = A'B \Rightarrow$$

$$\Rightarrow \sphericalangle \text{ of line } AB \text{ with } \beta, \widehat{ABA'} = b$$

In the plane  $\beta$  we draw through  $B$  a parallel line to  $a$  and through  $A'$  a parallel line to  $BB'$ . Their intersection is  $C$ , and  $\|A'B'\| = \|BC\|$ ,  $\|BB'\| = \|A'C\|$ . The angle of line  $AB$  with  $\alpha$  is  $\widehat{ABC} = c$ .

$$\text{As } AA' \perp \beta \Rightarrow AA' \perp A'C \Rightarrow \|AC\|^2 = \|AA'\|^2 + \|A'C\|^2 = \|AA'\|^2 + \|B'B\|^2 \quad (1)$$

$B'BCA$  rectangle

$$\left. \begin{array}{l} \Rightarrow A'C \perp CB \\ AA' \perp \beta \end{array} \right\} \Rightarrow AC \perp CB.$$

$$\Rightarrow \Delta ACB \text{ is right in } C.$$

We divide the relation (1) with  $\|AB\|^2$ :

$$\frac{\|AC\|^2}{\|AB\|^2} = \frac{\|AA'\|^2}{\|AB\|^2} + \frac{\|B'B\|^2}{\|AB\|^2} \Rightarrow \sin^2 c = \sin^2 b + \sin^2 a.$$

Solution to [Problem 189](#).

$$\begin{aligned} S' &= S \cos a \\ S'' &= S' \cos a \end{aligned}, \quad a \in (\widehat{\alpha, \beta})$$

$$\left. \begin{array}{l} \cos a = \frac{S'}{S} \\ \cos a = \frac{S''}{S'} \end{array} \right\} \Rightarrow \frac{S'}{S} = \frac{S''}{S'} \Rightarrow S'^2 = SS'' \Rightarrow S' = \sqrt{SS''}.$$

Solution to [Problem 190](#).

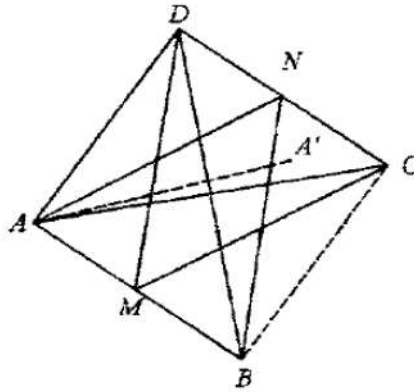

a.  $\left. \begin{array}{l} |AC| \equiv |BC| \Rightarrow \Delta ACB \text{ isosceles} \\ CM \text{ median} \end{array} \right\} \Rightarrow CM \perp AB \text{ (1)}$

$\left. \begin{array}{l} |AD| \equiv |BD| \Rightarrow \Delta ABD \text{ isosceles} \\ DM \text{ median} \end{array} \right\} \Rightarrow DM \perp AB \text{ (2)}$

From (1) and (2)  $\Rightarrow AB \perp (DMC) = \left. \begin{array}{l} AB \perp MN \\ AB \perp DC \end{array} \right\}$

$\left. \begin{array}{l} |BC| \equiv |BD| \\ BN \text{ median} \\ |AD| \equiv |AC| \\ AN \text{ median} \end{array} \right\} \Rightarrow \left. \begin{array}{l} BN \perp DC \\ AN \perp DC \end{array} \right\} \Rightarrow DC \perp (ABN) \Rightarrow DC \perp MN$

b.

$\left. \begin{array}{l} DC \perp MN \\ DC \perp AB \end{array} \right\} \Rightarrow \left. \begin{array}{l} DC \perp (ABN) \\ DC \subset (BDC) \end{array} \right\} \Rightarrow \left. \begin{array}{l} (BDC) \perp (ABN) \\ AA' \perp (BDC) \end{array} \right\} \Rightarrow \left. \begin{array}{l} AA' \subset (ABN) \\ A' \in (BDC) \end{array} \right\} \Rightarrow$

$\Rightarrow A' \in BN \Rightarrow B, A', N$  are collinear.

In the same way:

From  $(ADC) \perp (ABN) \Rightarrow A, B', N$  collinear

$(ABC) \perp (DMC) \Rightarrow M, D', C$  collinear

$(ABD) \perp (DMC) \Rightarrow D, C', M$  collinear

C. At point a. we've shown that  $MN \perp AB$

$\left. \begin{array}{l} AA' \perp (BDC) \\ BN \subset (BDC) \\ BB' \perp (ADC) \\ AN \subset (ADC) \end{array} \right\} \Rightarrow \left. \begin{array}{l} AA' \perp BN \\ A' \in BN \\ BB' \perp AN \\ B' \in AN \end{array} \right\} \Rightarrow$

$AA', BB'$  and  $MN$  are heights in  $\Delta ABN$ , so they are concurrent lines.

In the same way,  $DD', CC', MN$  will be heights in  $\Delta DMC$ .

Solution to [Problem 191](#).

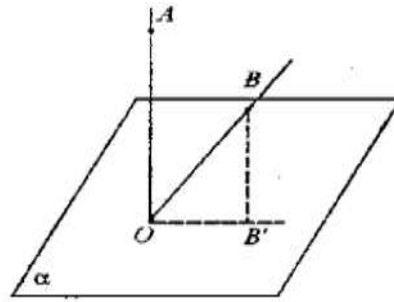

We assume that  $[OA, [OB$  are on the same side of plane  $\alpha$ .

We draw

$$\left. \begin{array}{l} BB' \perp \alpha \\ AO \perp \alpha \end{array} \right\} \Rightarrow BB' \parallel AO \Rightarrow$$

$(\exists)$  plane  $(AD, BB') = \beta \Rightarrow [OA, [OB$  are in the same half-plane.

$$AO \perp \alpha \Rightarrow AO \perp OB', \quad m(\widehat{BOB'}) < 90^\circ \Rightarrow [OB \subset \text{int } \widehat{AOB'}$$

In plane  $\beta$  we have  $m(\widehat{AOB}) = 90^\circ = m(\widehat{BOB'}) < 90^\circ \Rightarrow \widehat{AOB}$  acute.

We assume that  $[OA$  and  $[OB$  are in different half-planes in relation to  $\alpha \Rightarrow A$  and  $B$  are in different half-planes in relation to  $OB'$  in plane  $\beta \Rightarrow [OB' \subset \text{int } \widehat{BOA} \Rightarrow m(\widehat{AOB}) = 90^\circ + m(\widehat{BOB'}) > 90^\circ \Rightarrow AOB$  obtuse.

Solution to [Problem 192](#).

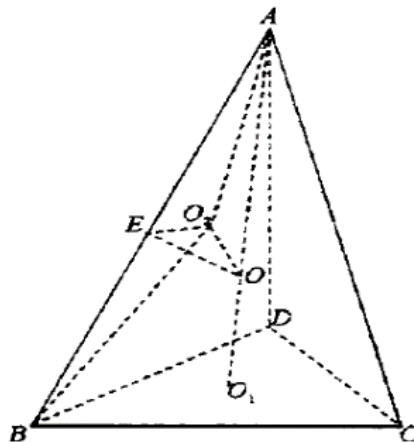

We know the locus of the points in space equally distant from the peaks of  $\Delta BCD$  is the perpendicular line  $d$  to the pl.  $\Delta$  in the center of the circumscribed circle of this  $\Delta$ , marked with  $O$ . We draw the mediator plane of side  $[AC]$ , which intersects this  $\perp d$  at point  $O$ . Then, point  $O$  is equally distant from all the peaks of the tetrahedron  $\|OA\| = \|OB\| = \|OC\| = \|OD\|$ . We connect  $O$  with midpoint  $E$  of side  $[AB]$ . From  $|OA| \equiv |OB| \Rightarrow \Delta OAB$  isosceles  $\Rightarrow OC \perp AB$  (1).



We project  $O$  onto plane  $(ABD)$  in point  $O_2$ .

$$\begin{aligned} \text{As } \left. \begin{array}{l} |OA| \equiv |OB| \equiv |OD| \\ |O)O_2 \text{ common side} \end{array} \right\} &\Rightarrow \Delta OAO_2 = \Delta OBO_2 = \Delta ODO_2 \\ \Rightarrow |O_2A| \equiv |BO_2| \equiv |DO_2| &\Rightarrow \end{aligned}$$

$\Rightarrow O_2$  is the center of the circumscribed circle of  $\Delta ABD$ . We show in the same way that  $O$  is also projected on the other faces onto the centers of the circumscribed circles, thus through  $O$  pass all the perpendicular lines to the faces of the tetrahedron. These lines are drawn through the centers of the circumscribed circles. *So b. is proved.*

$$\text{From } |O_2A| \equiv |OB_2| \Rightarrow \Delta O_2AB \text{ isosceles } O_2E \perp AB \quad (2)$$

$$\text{From (1) and (2) } \Rightarrow \left. \begin{array}{l} AB \perp (EO_2O) \\ |AE| \equiv |EB| \end{array} \right\} \Rightarrow$$

$\Rightarrow (EO_2O)$  is a mediator plane of side  $|AB|$  and passes through  $O$  and the intersection of the 3 mediator planes of sides  $|BC|, |CD|, |BD|$  belongs to line  $d$ , thus  $O$  is the common point for the 6 mediator planes of the edges of a tetrahedron.

Solution to [Problem 193](#).

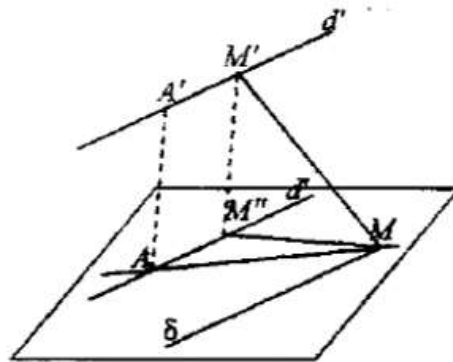

Let  $M \in d$  and  $\delta \parallel d'$ ,  $M \in \delta$ . Let  $\alpha = (d, \delta) \Rightarrow d' \parallel \alpha$ .

Let

$$\left. \begin{array}{l} d'' = \text{pr}_{\alpha} d' \\ d' \parallel \alpha \end{array} \right\} \Rightarrow d'' \parallel d' \Rightarrow d'' \parallel d' \Rightarrow d' \cap d =$$

$= \{A\}$  otherwise  $d$  and  $d'$  would be parallel, thus coplanar. Let  $\beta$  be the projective plane of line

$$\begin{aligned} d'' &\Rightarrow \beta \perp \alpha \\ \beta \cap \alpha &= d'' \end{aligned}$$

In plane  $\beta$  we construct a perpendicular to  $d''$  in point  $A$  and

$$\left. \begin{array}{l} AA' \perp d'' \\ d' \parallel d'' \end{array} \right\} \Rightarrow AA' \perp d'.$$

Solution to [Problem 194](#).

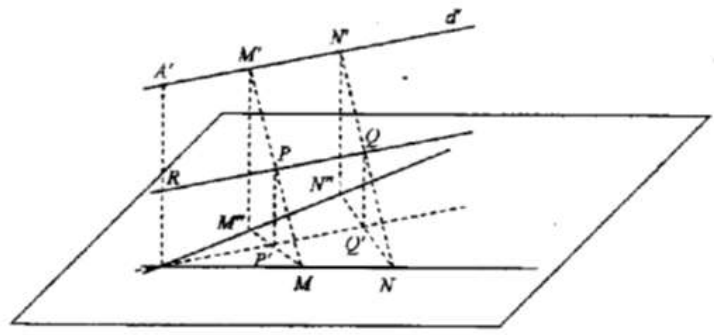

We draw

$$M'M'' \perp d' \Rightarrow M'M'' \perp d \Rightarrow M'M'' \perp M''M \Rightarrow \|M'M\| \geq \|M'M''\| = \|A'A\|.$$

We can obtain the equality only when  $M = A$  and  $M' = A'$ .

Solution to [Problem 195](#).

Let  $M \in d$ ,  $M' \in d'$  such that  $|AM| \equiv |A'M'|$ . Let  $d'' = \text{pr}_\alpha d'$  and  $M'M'' \perp d'' \Rightarrow M'M'' \perp \alpha \Rightarrow M'M'' \perp M''M$ .

$$\left. \begin{array}{l} M'' \parallel A'A \\ A'M' \parallel AM'' \end{array} \right\} \Rightarrow \left. \begin{array}{l} |A'M'| \equiv |AM''| \\ |A'M'| \equiv |AM| \end{array} \right\} \Rightarrow |AM| \equiv |AM'| \Rightarrow \Rightarrow \Delta AMM' \text{ isosceles.}$$

Let  $P$  be the midpoint of  $|MM'|$  and  $P' = \text{pr}_\alpha P \Rightarrow PP' \parallel M'M'' \Rightarrow P'$  is the midpoint of  $MM''$ ,  $\Delta AMM''$  isosceles  $\Rightarrow [AP'$  the bisector of  $\widehat{M'AM}$ .  $(PP')$  is midline in  $\Delta M'M''M \Rightarrow \|PP'\| = \frac{1}{2} \|M'M''\| = \frac{1}{2} \|A'A\| = \text{constant}$ .

Thus, the point is at a constant distance from line  $AP'$ , thus on a parallel line to this line, located in the  $\perp$  plane  $\alpha$ , which passes through  $AP'$ .

When  $M = A$  and  $M' = A' \Rightarrow \|AM\| = \|A'A\| = 0 \Rightarrow P = R$ , where  $R$  is the midpoint of segment  $|AA'|$ . So the locus passes through  $R$  and because

$$\left. \begin{array}{l} AA' \perp AP' \\ RP \parallel AP' \end{array} \right\} \Rightarrow RP \perp AA' \Rightarrow$$

$\Rightarrow RP$  is contained in the mediator plane of segment  $|AA'|$ .

So  $RP$  is the intersection of the mediator plane of segment  $|AA'|$  with the  $\perp$  plane to  $\alpha$ , passing through one of the bisectors of the angles determined by  $d$  and  $d'$ , we obtain one more line contained by the mediator plane of  $[AA']$ , the parallel line with the other bisector of the angles determined by  $d$  and  $d''$ .

So the locus will be formed by two perpendicular lines.

Vice-versa, let  $Q \in RP$  a  $(\forall)$  point on this line and  $Q' = \text{pr}_\alpha Q \Rightarrow Q' \in |AP'$  bisector.  
 We draw  $NN'' \perp AQ'$  and because  $AQ'$  is both bisector and height  $\Rightarrow \Delta ANN''$   
 isosceles  $\Rightarrow |AQ'|$  median  $\Rightarrow |NQ'| \equiv |Q'N''|$ .

We draw

$$N'N'' \perp d'' \Rightarrow \left. \begin{array}{l} |A'N'| \equiv |AN''| \\ |AN''| \equiv |AN| \end{array} \right\} \Rightarrow |AN| \equiv |A'N'|$$

$$QQ'' \parallel N'N'' \Rightarrow Q, Q', N', N'' \text{ coplanar} \Rightarrow N''Q' \in (QQ'N'N'') \Rightarrow N \in (QQ'N'N'')$$

As

$$\left. \begin{array}{l} \|Q'Q\| = \frac{1}{2}\|AA'\| = \frac{1}{2}\|N'N''\| \\ QQ' \parallel N'N'' \end{array} \right\} \Rightarrow$$

$$\Rightarrow |Q'Q| \text{ midline in } \Delta NN'N'' \Rightarrow Q, N', N \text{ collinear and } |QN'| \equiv |QN|.$$

Solution to [Problem 196](#).

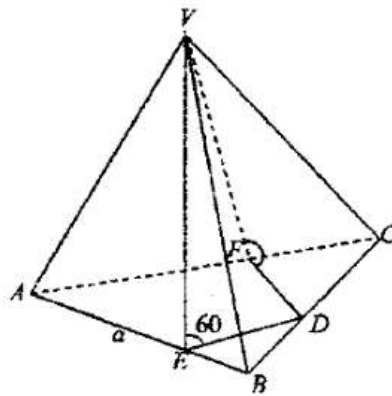

$$D = \text{pr}_{BC}V \text{ și } E = \text{pr}_{AB}V \quad FD = \text{pr}_{AC}V$$

$$(VBC) \perp (ABC) \Rightarrow VD \perp (ABC) \Rightarrow d(V, \alpha) = \|VD\|,$$

where  $\alpha = (ABC)$ .

$$\left. \begin{array}{l} VD \perp (ABC) \\ VE \perp AB \end{array} \right\} \Rightarrow DE \perp AB \Rightarrow m(\widehat{VED}) = 60^\circ$$

$$\left. \begin{array}{l} VD \perp (ABC) \\ VF \perp AC \end{array} \right\} \Rightarrow \left. \begin{array}{l} DF \perp AC \Rightarrow m(\widehat{VFD}) = 60^\circ \\ VD \text{ common side} \end{array} \right\} \Rightarrow$$

$$\Rightarrow \left. \begin{array}{l} \Delta VDE = \Delta VDF \Rightarrow |ED| \equiv |FD| \\ m(\widehat{B}) = m(\widehat{C}) = 60^\circ \end{array} \right\} \Rightarrow \Delta EDB \equiv \Delta FDC \Rightarrow |BD| \equiv |DC| \Rightarrow \|BD\| = \frac{a}{2}$$

$$\|ED\| = \frac{a}{2} \cdot \sin 60^\circ = \frac{a\sqrt{3}}{2 \cdot 2} = \frac{a\sqrt{3}}{4}$$

$$\|VD\| = \|ED\| \cdot \text{tg } 60^\circ = \frac{a\sqrt{3}}{4} \cdot \sqrt{3} = \frac{3a}{4}$$

Solution to [Problem 197](#).

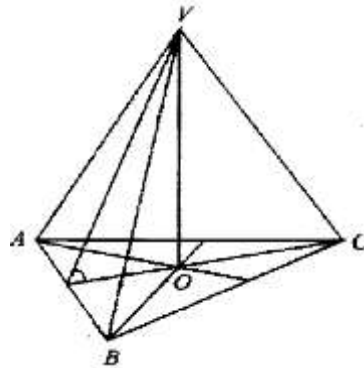

Let

$$O = \text{pr}_{(BAC)}V; \left. \begin{array}{l} \|VA\| = \|VB\| = \|VC\| = a \\ \|VO\| \text{ common} \end{array} \right\} \Rightarrow$$

$$\Rightarrow \triangle VAO \cong \triangle VBO \cong \triangle VCO \Rightarrow |OA| \cong |BO| \cong |CO| \Rightarrow$$

$\Rightarrow O$  is the center of the circumscribed circle and as  $\triangle ABC$  is equilateral  $\Rightarrow O$  is the centroid  $\Rightarrow$

$$\Rightarrow \|OM\| = \frac{1}{3}\|MC\| = \frac{1}{3} \cdot \frac{a\sqrt{3}}{2} = \frac{a\sqrt{3}}{6}$$

$$\|VM\| = \|MC\| = \sqrt{a^2 - \frac{a^2}{4}} = \frac{a\sqrt{3}}{2}$$

$$\triangle VOM \Rightarrow \cos(\widehat{VMO}) = \frac{\|OM\|}{\|VM\|} = \frac{\frac{a\sqrt{3}}{6}}{\frac{a\sqrt{3}}{2}} = \frac{1}{3} \Rightarrow \widehat{VMO} = \arccos \frac{1}{3}$$

Solution to [Problem 198](#).

$$\|DE\| = l$$

$$m(\widehat{DBE}) = \beta$$

$$\triangle EDB: \|DE\| = l \sin \beta$$

$$\|DB\| = l \cos \beta.$$

$$\|AB\| = a \Rightarrow \|DB\| = a\sqrt{2},$$

$$\|AB\| = \frac{\|DB\|}{\sqrt{2}} = \frac{l \cos \beta}{\sqrt{2}}.$$

In  $\triangle AEB$ , right in  $A$ :

$$\|AE\| = \sqrt{l^2 - \frac{l^2 \cos^2 \beta}{2}} = l\sqrt{\frac{2 - \cos^2 \beta}{2}} = l\sqrt{\frac{1 + \sin^2 \beta}{2}}$$

$$\triangle ADE (m(\widehat{D}) = 90^\circ) \quad \text{tg } \rho = \frac{\|DE\|}{\|AD\|} = \frac{\rho \sin \beta}{\frac{\rho \cos \beta}{\sqrt{2}}} = \sqrt{2} \text{tg } \beta.$$

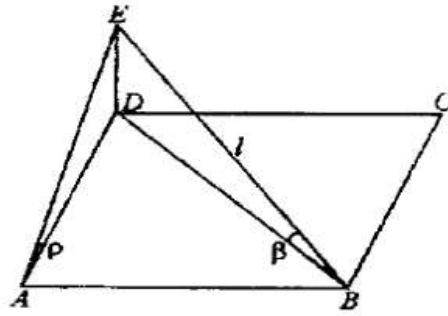

Solution to [Problem 199](#).

$\left. \begin{matrix} CE \perp BA \\ DE \perp AB \end{matrix} \right\} \Rightarrow \text{pl. } (ABC) \text{ and } ABD \text{ are } m(\overline{DEC}).$

$ABC \text{ equilateral} \Rightarrow \|CE\| = \frac{a\sqrt{3}}{2}.$

$\triangle CBD: \|DB\| = \frac{a}{\cos \beta} = \|AD\|$

$$DE^2 = \sqrt{\frac{a^2}{\cos^2 \beta} - \frac{a^2}{2}} = a\sqrt{\frac{\sin \beta}{\cos \beta}}$$

$$\cos \alpha = \frac{\|CO\|}{\|CE\|} = \frac{\frac{a\sqrt{3}}{2}}{a\sqrt{\frac{\sin \beta}{\cos \beta}}} = \frac{\sqrt{3} \cos \beta}{2 \cdot \sqrt{\sin \beta}}$$

$$\text{tg } \alpha \cdot \frac{\|CD\|}{\|CE\|} = \frac{\frac{a \cdot \sin \beta}{\cos \beta}}{\frac{a\sqrt{3}}{2}} = \frac{2}{\sqrt{3}} \cdot \text{tg } \beta.$$

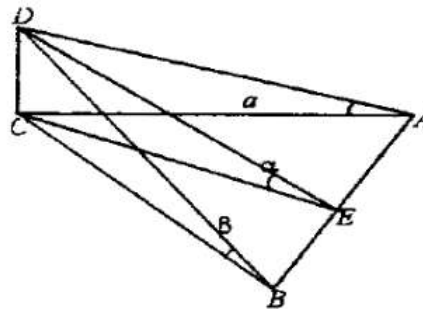

Solution to [Problem 200](#).

We consider the problem solved and we take on plane  $\alpha$ ,  $\triangle DEF$ , then points  $O$  and  $O'$  which are not located on  $\alpha$ .

We also construct lines  $|DO|, |FO|, |EO|$  respectively  $|DO'|, |FO'|, |EO'|$ . On these rays we take  $\triangle ABC$  and  $\triangle A'B'C'$ . Obviously, the way we have constructed the lines  $AD, BE, CF$  shows that they intersect at  $O$ . We extend lines  $BA, BC, CA$  until they intersect plane

$\alpha$  at points  $B, C$  respectively  $A$ . Then, we extend lines  $C'A', C'B', A'B'$  until they intersect plane  $\alpha$  at points  $A_2, C_2$  respectively  $B_2$ .

Obviously, points  $A_1, B_1, C_1$  are collinear (because  $\in \alpha \cap (ABC)$ ) and  $A_2, B_2, C_2$  are as well collinear (because  $\in \alpha \cap (A'B'C')$ ).

On the other side, points  $D, F, A_1, A_2$  are collinear because:

$$\left. \begin{array}{l} A_1 \in AC(ACOD) \\ A, D, F \in \alpha \end{array} \right\} \Rightarrow O, F, A_1 \in \alpha \cap (ACO),$$

thus collinear (1)

$$A_2 \in O'A' \subset (A'C'ODF)$$

$$D, F, A_2 \in \alpha$$

$$\Rightarrow D, F, A_2 \in \alpha \cap (C'A'O) \Rightarrow$$

$$\Rightarrow D, F, A_2 \text{ collinear (2)}$$

From (1) and (2)  $\Rightarrow D, F, A_1, A_2$  collinear. Similarly  $C, E, F, C_2$  collinear and  $B_1, E, D, D_2$  collinear.

Consequently,  $DEF$  is at the intersection of lines  $A_1A_2, C_1C_2, B_1B_2$  on plane  $\alpha$ , thus uniquely determined.

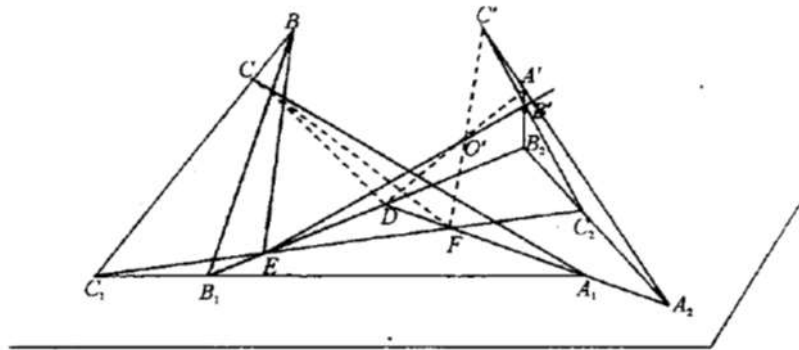

## Review Problems

201. Find the position of the third peak of the equilateral triangle, the affixes of two peaks being  $z_1 = 1, z_2 = 2 + i$ .

[Solution to Problem 201](#)

202. Let  $z_1, z_2, z_3$  be three complex numbers, not equal to 0, + two by two, and of equal moduli. Prove that if  $z_1 + z_2z_3, z_2 + z_3z_1, z_2 + z_1z_3 \in R \Rightarrow z_1z_2z_3 = 1$ .

[Solution to Problem 202](#)

203. We mark by  $G$  the set of  $n$  roots of the unit,  $G = \{\varepsilon_0, \varepsilon_1, \dots, \varepsilon_{n-1}\}$ . Prove that:

- $\varepsilon_i \cdot \varepsilon_j \in G, (\forall) i, j \in \{0, 1, \dots, n-1\}$ ;
- $\varepsilon_i^{-1} \in G, (\forall) i \in \{0, 1, \dots, n-1\}$ .

[Solution to Problem 203](#)

204. Let the equation  $az^2 + bz^2 + c = 0, a, b, c \in C$  and  $\arg a + \arg c = 2\arg b$ , and  $|a| + |c| = |b|$ . Show that the given equation has at list one root of unity.

[Solution to Problem 204](#)

205. Let  $z_1, z_2, z_3$  be three complex numbers, not equal to 0, such that  $|z_1| = |z_2| = |z_3|$ .

- Prove that  $(\exists)$  complex numbers  $\alpha$  and  $\beta$  such that  $z_2 = \alpha z_1, z_3 = \beta z_2$  and  $|\alpha| = |\beta| = 1$ ;
- Solve the equation  $\alpha^2 + \beta^2 - \alpha \cdot \beta - \alpha - \beta + 1 = 0$  in relation to one of the unknowns.
- Possibly using the results from *a.* and *b.*, prove that if  $z_1^2 + z_2^2 + z_3^2 = z_1z_2 + z_2z_3 + z_1z_3$ , then we have  $z_1 = z_2 = z_3$  or the numbers  $z_1, z_2, z_3$  are affixes of the peaks of an equilateral  $\Delta$ .

[Solution to Problem 205](#)

206. Draw a plane through two given lines, such that their line of intersection to be contained in a given plane.

[Solution to Problem 206](#)

207. Let  $a, b, c$  be three lines with a common point and  $P$  a point not located on any of them. Show that planes  $(Pa), (Pb), (Pc)$  contain a common line.

[Solution to Problem 207](#)

208. Let  $A, B, C, D$  be points and  $\alpha$  a plane separating points  $A$  and  $B$ ,  $A$  and  $C$ ,  $C$  and  $D$ . Show that  $\alpha \cap |BD| \neq \emptyset$  and  $\alpha \cap |AD| = \emptyset$ .

[Solution to Problem 208](#)

209. On edges  $a, b, c$  of a trihedral angle with its peak  $O$ , take points  $A, B, C$ ; let then  $D \in |BC|$  and  $E \in |AD|$ . Show that  $|OE| \subset \text{int. } \angle abc$ .

[Solution to Problem 209](#)

210. Show that the following sets are convex: the interior of a trihedral angle, a tetrahedron without an edge (without a face).

[Solution to Problem 210](#)

211. Let  $A, B, C, D$  be four non-coplanar points and  $E, F, G, H$  the midpoints of segments  $[AB], [BC], [CD], [DA]$ . Show that  $EF \parallel (ACD)$  and points  $E, F, G, H$  are coplanar.

[Solution to Problem 211](#)

212. On lines  $d, d'$  consider distinct points  $A, B, C; A', B', C'$  respectively. Show that we can draw through lines  $AA', BB', CC'$  three parallel planes if and only if  $\frac{\|AB\|}{\|A'B'\|} = \frac{\|BC\|}{\|B'C'\|}$ .

[Solution to Problem 212](#)



213. Let  $M, M'$  be each mobile points on the non-coplanar lines  $d, d'$ . Find the locus of points  $P$  that divide segment  $[MM']$  in a given ratio.

[Solution to Problem 213](#)

214. Construct a line that meets three given lines, respectively in  $M, N, P$  and for which  $\frac{\|MN\|}{\|NP\|}$  to be given ratio.

[Solution to Problem 214](#)

215. Find the locus of the peak  $P$  of the triangle  $M, N, P$  if its sides remain parallel to three fixed lines, the peak  $M$  describes a given line  $d$ , and the peak  $N \in$  a given plane  $\alpha$ .

[Solution to Problem 215](#)

216. On the edges  $[OA], [OB], [OC]$  of a trihedral angle we consider points  $M, N, P$  such that  $\|OM\| = \lambda\|OA\|, \|ON\| = \lambda\|OB\|, \|OP\| = \lambda\|OC\|$ , where  $\lambda$  is a positive variable number. Show the locus of the centroid of triangle  $MNP$ .

[Solution to Problem 216](#)

217.  $ABCD$  and  $A_1B_1C_1D_1$  are two parallelograms in space. We take the points  $A_2, B_2, C_2, D_2$  which divide segments  $[AA_1], [BB_1], [CC_1], [DD_1]$  in the same ratio. Show that  $A_2B_2C_2D_2$  is a parallelogram.

[Solution to Problem 217](#)

218. The lines  $d, d'$  are given, which cut a given plane  $\alpha$  in  $A$  and  $A'$ . Construct the points  $M, M'$  on  $d, d'$  such that  $MM' \parallel \alpha$  and segment  $[MM']$  to have a given length  $l$ . Discuss.

[Solution to Problem 218](#)

219. Construct a line which passes through a given point  $A$  and that is perpendicular to two given lines  $d$  and  $d'$ .

[Solution to Problem 219](#)

220. Show that there exist three lines with a common point, perpendicular two by two.

[Solution to Problem 220](#)

221. Let  $a, b, c, d$  four lines with a common point,  $d$  is perpendicular to  $a, b, c$ . Show that lines  $a, b, c$  are coplanar.

[Solution to Problem 221](#)

222. Show that there do not exist four lines with a common point that are perpendicular two by two.

[Solution to Problem 222](#)

223. Let  $d \perp \alpha$  and  $d' \parallel d$ . Show that  $d' \perp \alpha$ .

[Solution to Problem 223](#)

224. Show that two distinct perpendicular lines on a plane are parallel.

[Solution to Problem 224](#)

225. Let  $d \perp \alpha$  and  $d' \parallel \alpha$ . Show that  $d' \perp d$ .

[Solution to Problem 225](#)

226. Show that two perpendicular planes on the same line are parallel with each other.

[Solution to Problem 226](#)

227. Show that the locus of the points equally distant from two distinct points  $A$  and  $B$  is a perpendicular plane to  $AB$ , passing through midpoint  $O$  of the segment  $[AB]$  (called mediator plane of  $[AB]$ ).

[Solution to Problem 227](#)

228. Find the locus of the points in space equally distant from the peaks of a triangle  $ABC$ .

[Solution to Problem 228](#)

229. The plane  $\alpha$  and the points  $A \in \alpha, B \notin \alpha$  are given. A variable line  $d$  passes through  $A$  and it is contained in plane  $\alpha$ . Find the locus of the  $\perp$  feet from  $B$  to  $d$ .

[Solution to Problem 229](#)

230. A line  $\alpha$ , and a point  $A \notin \alpha$  are given. Find the locus of the feet of the perpendicular lines from  $A$  to planes passing through  $\alpha$ .

[Solution to Problem 230](#)

231. Consider a plane  $\alpha$  that passes through the midpoint of segment  $[AB]$ . Show that points  $A$  and  $B$  are equally distant from plane  $\alpha$ .

[Solution to Problem 231](#)

232. Through a given point, draw a line that intersects a given line and is  $\perp$  to another given line.

[Solution to Problem 232](#)

233. Let  $\alpha$  and  $\beta$  be two distinct planes and the line  $d$  their intersection. Let  $M$  be a point that is not located on  $\alpha \cup \beta$ . We draw the lines  $MM_1$  and  $MM_2 \perp$  on  $\alpha$  and  $\beta$ . Show that the line  $d$  is  $\perp$  to  $(MM_1MM_2)$ .

[Solution to Problem 233](#)

234. A plane  $\alpha$  and a point  $A, A \notin \alpha$  are given. Find the locus of points  $M \in \alpha$  such that segment  $|AM|$  has a given length.

[Solution to Problem 234](#)

235. Let  $O, A, B, C$  be four points such that  $OA \perp OB \perp OC \perp DA$  and we write

$$a = \|OA\|, b = \|OB\|, c = \|OC\|.$$

- a. Find the length of the sides of  $\Delta ABC$  in relation to  $a, b, c$ ;
- b. Find  $\sigma[ABC]$  and demonstrate the relation  $\sigma[ABC]^2 = \sigma[DAB]^2 + \sigma[OBC]^2 + \sigma[OCA]^2$ ;
- c. Show that the orthogonal projection of point  $O$  on plane  $(ABC)$  is the orthocenter  $H$  of  $\Delta ABC$ ;
- d. Find the distance  $\|OH\|$ .

[Solution to Problem 235](#)

236. Consider non-coplanar points  $A, B, C, D$  and lines  $AA', BB', CC', DD'$  perpendicular to  $(BCD), (ACD), (ABD)$ . Show that if lines  $AA'$  and  $BB'$  are concurrent, then lines  $CC', DD'$  are coplanar.

[Solution to Problem 236](#)

237. Let  $A, B, C, D$  four non-coplanar points. Show that  $AB \perp CD$  and  $AC \perp BD \Rightarrow AD \perp BC$ .

[Solution to Problem 237](#)

238. On the edges of a triangle with its peak  $O$ , take the points  $A, B, C$  such that  $|OA| \equiv |OB| \equiv |OC|$ . Show that the  $\perp$  foot in  $O$  to the plane  $(ABC)$  coincides with the point of intersection of the bisectors  $\Delta ABC$ .

[Solution to Problem 238](#)

239. Let a peak  $A$  of the isosceles triangle  $ABC$  ( $|AB| \equiv |AC|$ ) be the orthogonal projection onto  $A'$  on a plane  $\alpha$  which passes through  $BC$ . Show that  $\widehat{BA'C} > \widehat{BAC}$ .

[Solution to Problem 239](#)

240. With the notes of *Theorem 1*, let  $[AB'$  be the opposite ray to  $[AB''$ . Show that for any point  $M \in \alpha - [AB''$  we have  $\widehat{B''AB} > \widehat{MAB}$ .

[Solution to Problem 240](#)

241. Let  $\alpha$  be a plane,  $A \in \alpha$  and  $B$  and  $C$  two points on the same side of  $\alpha$  such that  $AC \perp \alpha$ . Show that  $\widehat{CAB}$  is the complement of the angle formed by  $[AB$  with  $\alpha$ .

[Solution to Problem 241](#)

242. Let  $\alpha'\beta'$  be a trihedral angle with edge  $m$  and  $A \in m$ . Show that of all the rays with origin at  $A$  and contained in half-plane  $\beta'$ , the one that forms with plane  $\alpha$  the biggest possible angle is that  $\perp p \in m$  (its support is called the line with the largest slope of  $\beta$  in relation to  $\alpha$ ).

[Solution to Problem 242](#)

243. Let  $\alpha$  be a plane,  $\sigma$  a closed half-plane, bordered by  $\alpha$ ,  $\alpha'$  a half-plane contained in  $\alpha$  and  $a$  a real number between  $0^\circ$  and  $180^\circ$ . Show that there is only one half-space  $\beta'$  that has common border with  $\alpha'$  such that  $\beta' \subset \sigma$  and  $m(\alpha'\beta') = a$ .

[Solution to Problem 243](#)

244. Let  $(\widehat{\alpha'\beta'})$  be a proper dihedral angle. Construct a half-plane  $\gamma'$  such that  $m(\widehat{\alpha'\beta'}) = m(\widehat{\gamma'\beta'})$ . Show that the problem has two solutions, one of which is located in the int.  $\widehat{\alpha'\beta'}$  (called bisector half-plane of  $\widehat{\alpha'\beta'}$ ).

[Solution to Problem 244](#)

245. Show that the locus of the points equally distant from two secant planes  $\alpha, \beta$  is formed by two  $\perp$  planes, namely by the union of the bisector planes of the dihedral angles  $\alpha$  and  $\beta$ .

[Solution to Problem 245](#)

246. If  $\alpha$  and  $\beta$  are two planes,  $Q \in \beta$  and  $d \perp$  through  $Q$  on  $\alpha$ . Show that  $d \subset \beta$ .

[Solution to Problem 246](#)

247. Consider a line  $d \subset \alpha$ . Show that the union of the  $\perp$  lines to  $\alpha$ , which intersect line  $d$ , is a plane  $\perp \alpha$ .

[Solution to Problem 247](#)

248. Find the locus of the points equally distant from two concurrent lines.

[Solution to Problem 248](#)

249. Show that a plane  $\alpha \perp$  to two secant planes is  $\perp$  to their intersection.

[Solution to Problem 249](#)

250. Let  $A$  be a point that is not on plane  $\alpha$ . Find the intersection of all the planes that contain point  $A$  and are  $\perp$  to plane  $\alpha$ .

[Solution to Problem 250](#)

251. From a given point draw a  $\perp$  plane to two given planes.

[Solution to Problem 251](#)

252. Intersect a dihedral angle with a plane as the angle of sections is right.

[Solution to Problem 252](#)

253. Show that a line  $d$  and a plane  $\alpha$ , which are perpendicular to another plane, are parallel or line  $d$  is contained in  $\alpha$ .

[Solution to Problem 253](#)

254. If three planes are  $\perp$  to a plane, they intersect two by two after lines  $a, b, c$ . Show that  $a \parallel b \parallel c$ .

[Solution to Problem 254](#)

255. From a point  $A$  we draw perpendicular lines  $AB$  and  $AC$  to the planes of the faces of a dihedral angle  $\widehat{\alpha'\beta'}$ . Show that  $m(\widehat{BAC}) = m(\widehat{\alpha'\beta'})$  or  $m(\widehat{BAC}) = 180^\circ - m(\widehat{\alpha'\beta'})$ .

[Solution to Problem 255](#)

## Solutions

Solution to [Problem 201](#).

$$M_1 - z_1 = 1$$

$$M_2 - z_1 = 2 + i$$

$$M_1 - z_1 = x + yi$$

$$\Delta M_1 M_2 M_3 \text{ equilateral} \Rightarrow \|M_1 M_2\| = \|M_1 M_3\| = \|M_2 M_3\| \Rightarrow |z_2 - z_1| = |z_3 - z_2| = |z_1 - z_3|$$

$$\Rightarrow \sqrt{2} = \sqrt{(x-2)^2 + (y-1)^2} \Rightarrow \begin{cases} (x-2)^2 + (y-1)^2 = 2 \\ (1-x)^2 + y^2 = 2 \end{cases} \Rightarrow \begin{cases} x+y=2 \\ x^2+y^2-2x=1 \end{cases}$$

$$\Rightarrow y = 2 - x$$

$$x^2 + 4 + x^2 - 4x - 2x = 1 \Rightarrow x_{1,2} = \frac{3 \pm \sqrt{3}}{2} \Rightarrow \begin{cases} y_1 = \frac{1 - \sqrt{3}}{2} \\ y_2 = \frac{1 + \sqrt{3}}{2} \end{cases}$$

$$\text{Thus: } M_3 \left( \frac{3+\sqrt{3}}{2}, \frac{1-\sqrt{3}}{2} \right) \text{ or } M_3 \left( \frac{3-\sqrt{3}}{2}, \frac{1+\sqrt{3}}{2} \right).$$

There are two solutions!

Solution to [Problem 202](#).

$$z_1 = r(\cos t_1 + i \sin t_1)$$

$$z_2 = r(\cos t_2 + i \sin t_2)$$

$$z_3 = r(\cos t_3 + i \sin t_3)$$

$$z_1 \neq z_2 \neq z_3 \Rightarrow t_1 \neq t_2 \neq t_3$$

$$\begin{cases} z_1 + z_2 z_3 \in \mathbb{R} \Rightarrow \sin t_1 + r \sin(t_2 + t_3) = 0 \\ z_2 + z_3 z_1 \in \mathbb{R} \Rightarrow \sin t_2 + r \sin(t_1 + t_3) = 0 \\ z_3 + z_1 z_2 \in \mathbb{R} \Rightarrow \sin t_3 + r \sin(t_1 + t_2) = 0 \end{cases} \Rightarrow$$

$$\begin{cases} \sin t_1(1 - r \cos t) + r \sin t \cdot \cos t_1 = 0 \\ \sin t_2(1 - r \cos t) + r \sin t \cdot \cos t_2 = 0 \\ \sin t_3(1 - r \cos t) + r \sin t \cdot \cos t_3 = 0 \end{cases}$$

$$t_1 \neq t_2 \neq t_3$$

These equalities are simultaneously true only if  $1 - r \cdot \cos t = 0$  and  $r \cdot \sin t = 0$ , as  $r \neq 0 \Rightarrow \sin t = 0 \Rightarrow t = 0 \Rightarrow \cos t = 1 \Rightarrow 1 - r = 0 \Rightarrow r = 1$ , so  $z_1 z_2 z_3 = 1 \cdot (\cos 0 + i \sin 0) = 1$ .

Solution to [Problem 203](#).

a.  $\varepsilon_k = \frac{2k\pi}{n} + i \sin \frac{2k\pi}{n}, k \in \{0, 1, \dots, n-1\}$ .

So  $\left. \begin{matrix} \varepsilon_i = \cos \frac{2i\pi}{n} + i \sin \frac{2i\pi}{n} \\ \varepsilon_j = \cos \frac{2j\pi}{n} + i \sin \frac{2j\pi}{n} \end{matrix} \right\} \Rightarrow \varepsilon_i \varepsilon_j = \cos \frac{2\pi(i+j)}{n} + i \sin \frac{2\pi(i+j)}{n}, i, j \in \{0, 1, \dots, n-1\}$ .

1)  $i + j < n - 1 \Rightarrow i + j = k \in \{0, 1, \dots, n-1\} \Rightarrow \varepsilon_i \varepsilon_j = \varepsilon_k \in G$ ;

2)  $i + j = n \Rightarrow \varepsilon_i \varepsilon_j = \cos 2\pi + i \sin 2\pi = 1 = \varepsilon_0 \in G$ ;

3)  $i + j > n \Rightarrow i + j = n \cdot m + r, 0 \leq r < n, \varepsilon_i \varepsilon_j = \cos \frac{2\pi(n \cdot m + r)}{n} + i \sin \frac{2\pi(n \cdot m + r)}{n} = \cos \left( 2\pi m + \frac{2\pi r}{n} \right) + i \sin \left( 2\pi m + \frac{2\pi r}{n} \right) = \cos \frac{2\pi r}{n} + i \sin \frac{2\pi r}{n} = \varepsilon_r \in G$ .

b.  $\varepsilon_i = \cos \frac{2\pi i}{n} + i \sin \frac{2\pi i}{n}$

$$\varepsilon_i^{-1} = \frac{1}{\varepsilon_i} = \frac{\cos 0 + i \sin 0}{\cos \frac{2\pi i}{n} + i \sin \frac{2\pi i}{n}} = \cos \left( -\frac{2\pi i}{n} \right) + i \sin \left( -\frac{2\pi i}{n} \right) = \cos \left( 2\pi - \frac{2\pi i}{n} \right) + i \sin \left( 2\pi - \frac{2\pi i}{n} \right) = \cos \frac{2\pi(n-i)}{n} + i \sin \frac{2\pi(n-i)}{n},$$

$i \in \{0, 1, \dots, n-1\}$ .

If  $i = 0 \Rightarrow n - i = n \Rightarrow \varepsilon_0^{-1} = \varepsilon_0 \in g$ .

If  $i \neq 0 \Rightarrow n - i \leq n - 1 \Rightarrow h = n - i \in \{0, 1, \dots, n-1\} \Rightarrow \varepsilon_i^{-1} = \cos \frac{2\pi h}{n} + i \sin \frac{2\pi h}{n} \in G$ .

Solution to [Problem 204](#).

$$\begin{cases} a = r_1(\cos t_1 + i \sin t_1) \\ b = r_2(\cos t_2 + i \sin t_2) \\ c = r_3(\cos t_3 + i \sin t_3) \end{cases}$$

$\arg a + \arg c = 2 \arg b \Rightarrow t_1 + t_3 = 2t_2$

and  $|a| + |c| = |b| \Rightarrow r_1 + r_3 = r_2$

$$\begin{aligned} az^2 + bz + c = 0 &\Rightarrow z_{1,2} = \frac{-b \pm \sqrt{b^2 - 4ac}}{2a} \\ &= \frac{-r_2(\cos t_2 + i \sin t_2) \pm \sqrt{r_2^2(\cos 2t_2 + i \sin 2t_2) - 4r_1r_3(\cos(t_1 + t_3) + i \sin(t_1 + t_3))}}{2r_1(\cos t_1 + i \sin t_1)} \\ &= \frac{-r_2(\cos t_2 + i \sin t_2) \pm \sqrt{(\cos 2t_2 + i \sin 2t_2)(r_2^2 - 4r_1r_3)}}{2r_1(\cos t_1 + i \sin t_1)} \end{aligned}$$

But  $r_1 + r_3 = r_2 \Rightarrow r_2^2 = r_1^2 + r_1^2 + r_3^2 + 2r_1r_3 \Rightarrow r_2^2 - 4r_1r_3 = r_1^2 + r_1^2 + r_3^2 + 2r_1r_3 - 4r_1r_3 = (r_1 - r_3)^2$ .



Therefore:

$$z_{1,2} = \frac{-r_2(\cos t_2 + i \sin t_2) \pm (\cos t_2 + i \sin t_2)(r_1 - r_3)}{2r_1(\cos t_1 + i \sin t_1)}$$

We observe that:

$$z_2 = \frac{(\cos t_2 + i \sin t_2)(-2r_1)}{2r_1(\cos t_1 + i \sin t_1)} = -[\cos(t_2 - t_1) + i \sin(t_2 - t_1)] = \cos[\pi + (t_2 - t_1)] + i \sin[\pi + t_2 - t_1] \text{ and } t_2 = 1.$$

Solution to [Problem 205](#).

Let

$$\begin{cases} z_1 = r(\cos t_1 + i \sin t_1) \\ z_2 = r(\cos t_2 + i \sin t_2), \\ z_3 = r(\cos t_3 + i \sin t_3) \end{cases} \quad r \neq 0$$

Let

$$\alpha = r_4(\cos t_4 + i \sin t_4)$$

$$\beta = r_5(\cos t_5 + i \sin t_5)$$

$$z_2 = \alpha z_1 \Rightarrow r(\cos t_2 + i \sin t_2) = r \cdot r_4[\cos(t_1 + t_4) + i \sin(t_1 + t_4)] \Rightarrow$$

$$\Rightarrow \begin{cases} r = r \cdot r_4 \\ t_4 + t_1 = t_2 + 2k\pi \end{cases} \Rightarrow \begin{cases} r_4 = 1 \\ t_4 = t_2 - t_1 + 2k\pi \end{cases} \Rightarrow \begin{cases} |\alpha| = 1 \\ t_4 = t_2 - t_1 + 2k\pi \end{cases}$$

So  $\alpha$  is determined.

$$z_3 = \beta z_1 \Rightarrow r(\cos t_3 + i \sin t_3) = r \cdot r_5[\cos(t_1 + t_5) + i \sin(t_1 + t_5)] \Rightarrow$$

$$\Rightarrow \begin{cases} r = r \cdot r_5 \\ t_5 + t_1 = t_3 + 2k\pi \end{cases} \Rightarrow \begin{cases} r_5 = 1 \\ t_5 = t_3 - t_1 + 2k\pi \end{cases} \Rightarrow \begin{cases} |\beta| = 1 \\ t_5 = t_3 - t_1 + 2k\pi \end{cases}$$

So  $\beta$  is determined.

If we work with reduced arguments, then  $t_4 = t_2 - t_1$  or  $t_4 = t_2 - t_1 + 2\pi$ , in the same way  $t_5$ .

b)  $\alpha^2 + \alpha(-\beta - 1) + \beta^2 - \beta + 1 = 0$

$$\alpha_{1,2} = \frac{\beta + 1 \pm \sqrt{\beta^2 + 2\beta + 1 - 4\beta^2 + 4\beta - 4}}{2} = \frac{\beta + 1 \pm \sqrt{-3\beta^2 + 6\beta - 3}}{2} = \frac{\beta + 1 + i(\beta - 1)\sqrt{3}}{2}$$

$$\alpha_1 = \frac{\beta + i(\beta - 1)\sqrt{3}}{2}, \quad \alpha_2 = \frac{\beta - i(\beta - 1)\sqrt{3}}{2}$$

c)  $z_1^2 + z_2^2 + z_3^2 = z_1 z_2 + z_2 z_3 + z_1 z_3$

According to *a.* (∃) the complex numbers of modulus 1,  $\alpha$  and  $\beta$  such that  $z_2 = \alpha z_1$  and  $z_3 = \beta z_1$ .

In the given relation, by substitution we obtain:

$$z_1^2 + \alpha^2 z_1^2 + \beta^2 z_1^2 = \alpha z_1^2 + \alpha\beta z_1^2 + \beta z_1^2 = \left. \begin{array}{l} \\ z_1 \neq 0 \end{array} \right\} \Rightarrow 1 + \alpha^2 + \beta^2 - \alpha - \beta - \alpha \cdot \beta = 0$$

$\alpha = 1$  and  $\beta = 1$  verify this equality, so in this case  $z_2 = z_3 = z_1$ .

According to point *b.*

$$\alpha_1 = \frac{\beta + i(\beta - 1)\sqrt{3}}{2},$$

where  $\beta = x + iy$ , when

$$|\beta| = 1 \Rightarrow \sqrt{x^2 + y^2} = 1 \Rightarrow$$

$$x^2 + y^2 = 1 \quad (1)$$

$$\alpha = \frac{x + iy + 1 + i(x + iy - 1)\sqrt{3}}{2} = \frac{(x + 1 - y\sqrt{3}) + i(y + x\sqrt{3} - \sqrt{3})}{2} \left. \begin{array}{l} \\ |\alpha| = 1 \end{array} \right\} \Rightarrow$$

$$\Rightarrow |\alpha| = \sqrt{\left(\frac{x + 1 - y\sqrt{3}}{2}\right)^2 + \left(\frac{y + x\sqrt{3} - \sqrt{3}}{2}\right)^2} = \sqrt{x^2 + y^2 - x + 1y\sqrt{3}} = 1$$

We construct the system:

$$\left\{ \begin{array}{l} x^2 + y^2 = 1 \\ x^2 + y^2 - x - y\sqrt{3} = 0 \end{array} \right. \Leftrightarrow \left\{ \begin{array}{l} x^2 + y^2 = 1 \\ 1 - x - y\sqrt{3} = 0 \end{array} \right. \Rightarrow \left\{ \begin{array}{l} x = 1 - y\sqrt{3} \\ y(2y - \sqrt{3}) = 0 \end{array} \right. \Rightarrow \left\{ \begin{array}{l} x = 0 \\ y = 0 \\ \beta = 1 \end{array} \right. \Rightarrow$$

$$\Rightarrow 1 + \alpha^2 + 1 - \alpha - 1 - \alpha = 0 \Rightarrow \alpha = 1$$

The initial solution leads us to  $z_1 = z_2 = z_3$ .

$$y = \frac{\sqrt{3}}{2} \Rightarrow x = -\frac{1}{2}$$

and gives

$$-\frac{1}{2} + \frac{\sqrt{3}}{2}i$$

By substituting,

$$1 + \frac{1}{4} - \frac{3}{4} - \frac{\sqrt{3}}{2}i + \frac{1}{2} - \frac{i\sqrt{3}}{2} + \alpha^2 - \alpha - \alpha \left(-\frac{1}{2} + \frac{\sqrt{3}}{2}i\right) = 0 \Rightarrow$$

$$\Rightarrow 2\alpha^2 - \alpha(1 + \sqrt{3}i) + 2(1 - \sqrt{3}i) = 0$$

$$\alpha_{1,2} = \frac{(1 + \sqrt{3}) \pm 3\sqrt{-2 + 2\sqrt{3}i}}{4} = \frac{(1 + \sqrt{3}i) \pm 3(1 + \sqrt{3}i)}{4}$$

$$\alpha_1 = \frac{4(1 + \sqrt{3}i)}{4},$$

$|\alpha| = 2$  does not comply with the condition  $|\alpha| = 1$ .

But

$$\alpha_2 = \frac{-2(1 + \sqrt{3}i)}{4} = -\frac{1}{2} - \frac{\sqrt{3}}{2}i, \quad |\alpha_2| = 1$$

so

$$\begin{cases} \alpha = -\frac{1}{2} - \frac{\sqrt{3}}{2}i = \cos \frac{4\pi}{3} + i \sin \frac{4\pi}{3} \\ \beta = -\frac{1}{2} + \frac{\sqrt{3}}{2}i = \cos \frac{2\pi}{3} + i \sin \frac{2\pi}{3} \end{cases}$$

If

$$z_1 = r(\cos t_1 + i \sin t_1),$$

then

$$z_2 = \alpha z_1 = r \cdot \left[ \cos \left( t_1 + \frac{4\pi}{3} \right) + i \sin \left( t_1 + \frac{4\pi}{3} \right) \right]$$

and then

$$z_3 = \beta z_2 = r \cdot \left[ \cos \left( t_1 + \frac{2\pi}{3} \right) + i \sin \left( t_1 + \frac{2\pi}{3} \right) \right].$$

If

$$M_1(t_1), M_2(t_2), M_3(t_3)$$

are on the circle with radius  $r$  and the arguments are

$$t_1, t_1 + \frac{2\pi}{3},$$

$$t_1 + \frac{4\pi}{3} \Rightarrow$$

they are the peaks of an equilateral triangle.

Solution to [Problem 206](#).

a. We assume that  $d \cap \alpha \neq \emptyset$  and  $d' \cap \alpha = \{B\}$ .

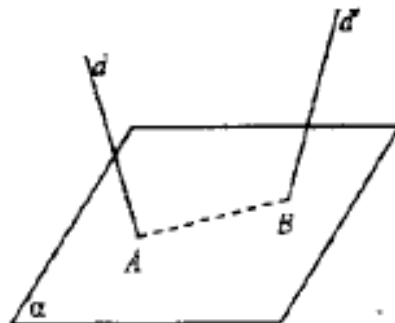

Let  $d \cap \alpha = \{A\}$  and  $d' \cap \alpha = \{B\}$  and the planes determined by pairs of concurrent lines  $(d, AB)$ ;  $(d', AB)$ .

We remark that these are the required planes, because  
 $d \subset (d, AB)$ ,  $d' \subset (d', AB)$  și  $(d, AB) \cap (d', AB) = AB \subset \alpha$ .

b. We assume  $d \cap \alpha = \{A\}$  and  $d' \parallel \alpha$ .

We draw through  $A$ , in plane  $\alpha$ , line  $d'' \parallel d$  and we consider planes  $(d, d'')$  and  $(d', d'')$  and we remark that

$$(d, d'') \cap (d', d'') = d'' \subset \alpha$$

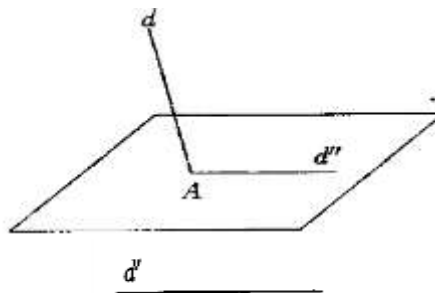

c. We assume  $d \cap \alpha = \emptyset$  and  $d' \cap \alpha = \emptyset$  and  $d' \in \text{direction } d$ .

Let  $A \in \alpha$  and  $d'' \parallel d \Rightarrow d'' \parallel d'$  and the planes are  $(d, d'')$  and  $(d', d'')$ . The reasoning is the same as above.

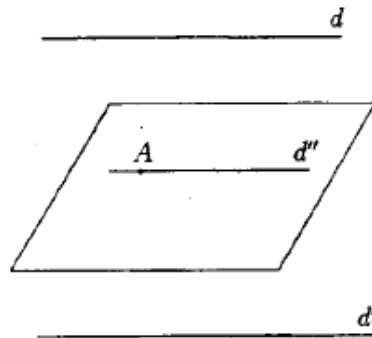

Solution to [Problem 207](#).

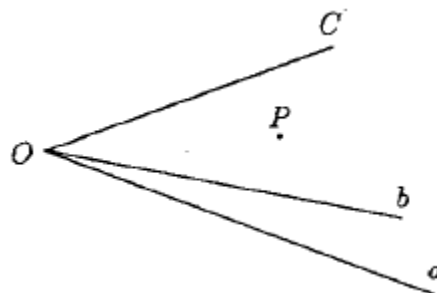

$$\begin{aligned}
 a \cap b \cap c &= \{O\} \\
 \left. \begin{array}{l} P \in (Pa) \\ O \in (Pa) \end{array} \right\} &\Rightarrow OP \subset (Pa) \\
 \left. \begin{array}{l} P \in (Pb) \\ O \in (Pb) \end{array} \right\} &\Rightarrow OP \subset (Pb) \\
 \left. \begin{array}{l} P \in (Pc) \\ O \in (Pc) \end{array} \right\} &\Rightarrow OP \subset (Pc) \\
 \Rightarrow (Pa) \cap (Pb) \cap (Pc) &= OP
 \end{aligned}$$

Solution to [Problem 208](#).

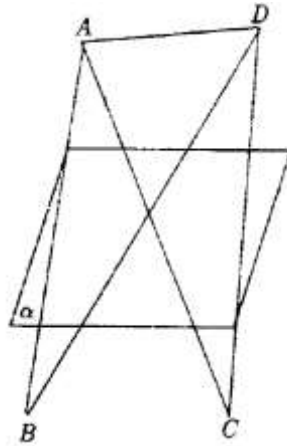

If  $\alpha$  separates points  $A$  and  $B$ , it means they are in different half-spaces and let  $\sigma = |\alpha A$  and  $\sigma' = |\alpha B$ .

Because  $\alpha$  separates  $A$  and  $C \Rightarrow C \in \sigma'$ .

Because  $\alpha$  separates  $C$  and  $D \Rightarrow D \in \sigma$ .

From  $B \in \sigma'$  and  $D \in \sigma \Rightarrow \alpha$  separates points  $B$  and  $D$

$$|BD| \cap \alpha \neq \emptyset.$$

From  $A \in \sigma$  and  $D \in \sigma \Rightarrow |BD| \cap \alpha = \emptyset.$

Solution to [Problem 209](#).

$$\left. \begin{array}{l} B \in (ab) \\ C \in (a, b), c \end{array} \right\} \Rightarrow [BC] \subset (a, b), c \Rightarrow$$

$$\begin{aligned} &\Rightarrow |OE \subset |(bc), A \quad (2) \\ &\left. \begin{array}{l} C \in (ac) \\ B \in |(ac), c \end{array} \right\} \Rightarrow [CB] \subset |(ac), B \Rightarrow \left. \begin{array}{l} D \in |(ac), B \\ A \in (a, c) \end{array} \right\} \Rightarrow [AD] \subset |(ac), B \\ &\Rightarrow \left. \begin{array}{l} E \in |(ac), B \\ O \in (a, c) \end{array} \right\} \Rightarrow [AD] \subset |(ac), B \Rightarrow \left. \begin{array}{l} E \in |(ac), B \\ O \in (ac) \end{array} \right\} \Rightarrow |OE \subset |(ac), B \quad (3) \end{aligned}$$

From (1), (2), (3)

$$\Rightarrow |OE \subset |(ab), c \cap |(bc), A \cap |(ac), B = \text{int. } \widehat{abc}.$$

Solution to [Problem 210](#).

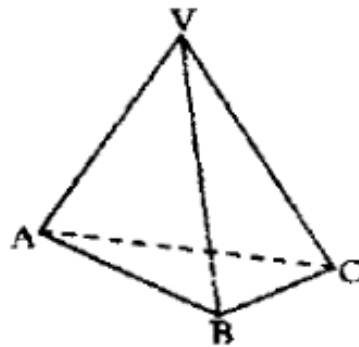

- a.  $\text{int.}(|VA, |\widehat{VB}, |VC) = |(VAB), C \cap |(VBC), A \cap |(VAC), B$  is thus an intersection of convex set and thus the interior of a trihedron is a convex set.
- b. Tetrahedron  $[VABC]$  without edge  $[AC]$ . We mark with  $\mathcal{M}_1 = [ABC] - [AC] = [AB, C \cap [BC, A \cap |AC, B$  is thus a convex set, being intersection of convex sets.

$$|(ABC), V \cap \mathcal{M}_1$$

is a convex set.

In the same way

$$|(VAC), B \cup \mathcal{M}_2$$

is a convex set, where

$$\mathcal{M}_2 = [VAC] - [AC].$$

But  $[VABC] - [AC] =$

$$|(VAB), C \cap |(VBC), A \cap (|(ABC), V \cup \mathcal{M}_1) \cap (|(VAC), B \cup \mathcal{M}_2)$$

and thus it is a convex set as intersection of convex sets.

- c. Tetrahedron  $[VABC]$  without face  $[ABC]$

$$[VABC] - [ABC] = [(VAB), C \cap [(VBC), A \cap [(VAC), B \cap [(ABC),$$

$V$  is thus intersection of convex sets  $\Rightarrow$  is a convex set.

Solution to [Problem 211](#).

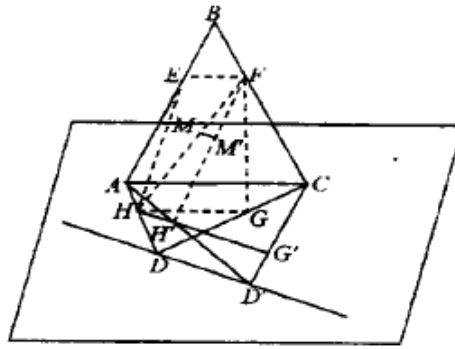

In plane  $(BAC)$  we have  $EF \parallel AC$ . In plane  $(DAC)$  we have  $AC \subset (DAC) \Rightarrow EF \parallel (DAC)$ .  
 In this plane we also have  $HG \parallel AC$ . So  $EF \parallel HG \Rightarrow E, F, G, H$  are coplanar and because  
 $\|EF\| = \frac{\|AC\|}{2} = \|HG\| \Rightarrow EFGH$  is a parallelogram.

Solution to [Problem 212](#).

We assume we have  $\alpha \parallel \beta \parallel \gamma$  such that  $AA' \subset \alpha, BB' \subset \beta, CC' \subset \gamma$ .

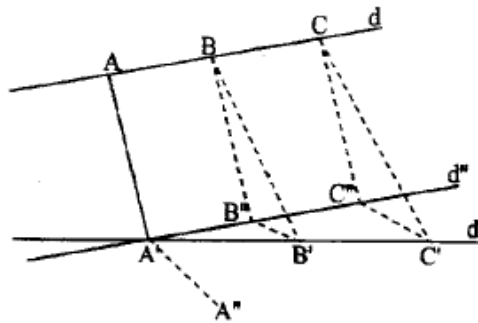

We draw through  $A'$  a parallel line with  $d: d'' \parallel d$ . As  $d$  intersects all the 3 planes  $A' \subset d''$  at  $A, B, C \Rightarrow$  and its  $\parallel d''$  cuts them at  $A', B'', C''$ .

Because

$$\left. \begin{array}{l} \alpha \parallel \beta \parallel \gamma \\ d \parallel d'' \end{array} \right\} \Rightarrow \begin{array}{l} \|AB\| = \|A'B''\| \\ \|BC\| = \|B''C''\| \end{array} \quad (1)$$

Let plane  $(d', d'')$ . Because this plane has in common with planes  $\alpha, \beta, \gamma$  the points  $A', B'', C''$  and because  $\alpha \parallel \beta \parallel \gamma \Rightarrow$  it intersects them after the parallel lines

$$\|C'C''\| \xrightarrow{\text{Thales}} \frac{\|A'B''\|}{\|A'B'\|} = \frac{\|B''C''\|}{\|B'C'\|} \quad (2)$$

Taking into consideration (1) and (2)

$$\Rightarrow \frac{\|AB\|}{\|A'B'\|} = \frac{\|BC\|}{\|B'C'\|}$$

The vice-versa can be similarly proved.

Solution to [Problem 213](#).

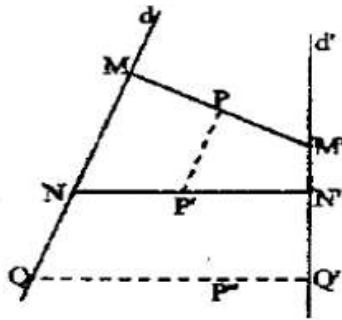

Let

$$P \in |MM'|$$

such that

$$\frac{\|MP\|}{\|PM'\|} = k$$

and

$$P' \in |NN'|$$

such that

$$\frac{\|NP'\|}{\|P'N'\|} = k$$

So

$$\frac{\|MP\|}{\|PM'\|} = \frac{\|NP'\|}{\|P'N'\|} \Rightarrow \frac{\|MP\|}{\|NP'\|} = \frac{\|PM'\|}{\|P'N'\|}$$

according to problem 7, three planes can be drawn  $\|\beta\| \alpha \|\gamma\|$  such that

$$MN \subset \beta, PP' \subset \alpha, M'N' \subset \gamma.$$

$$\left. \begin{array}{l} \beta \|\alpha \\ MN \subset \beta \end{array} \right\} \Rightarrow MN \|\alpha \Rightarrow d \|\alpha$$

$$\left. \begin{array}{l} \alpha \|\gamma \\ M'N' \subset \gamma \end{array} \right\} \Rightarrow M'N' \|\alpha \Rightarrow d' \|\alpha$$

and  $PP' \subset \alpha$ .

So by marking  $P$  and letting  $P'$  variable,  $P' \in \alpha$  a parallel plane with the two lines, which passes through  $P$ . It is known that this plane is unique, because by drawing through  $P$  parallel lines to  $d$  and  $d'$  in order to obtain this plane, it is well determined by 2 concurrent lines.

*Vice-versa:* Let  $P \in \alpha$ , that is the plane passing through  $P$  and it is parallel to  $d$  and  $d'$ .



$(P'', d)$  determines a plane, and  $(P'', d')$  determines a plane  $\Rightarrow$  the two planes, which have a common point, intersect after a line  $(P'', d) \cap (P'', d') = QQ'$  where  $Q \in d$  and  $Q' \in d'$ .

Because

$$d \parallel \alpha \Rightarrow MQ \parallel \alpha \Rightarrow (\exists)\beta$$

such that  $MQ \subset \beta, \beta \parallel \alpha$ .

Because

$$d' \parallel \alpha \Rightarrow M'Q' \parallel \alpha \Rightarrow (\exists)\gamma$$

such that  $M'Q' \subset \gamma, \gamma \parallel \alpha$ .

So the required locus is a parallel plane with  $d$  and  $d'$ .

Solution to [Problem 214](#).

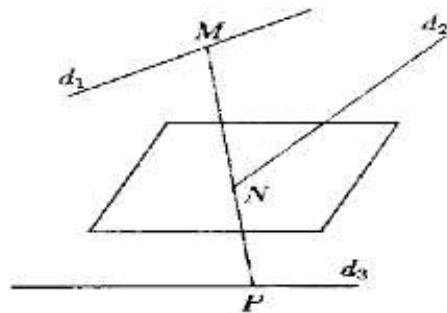

We consider the plane, which according to a previous problem, represents the locus of the points dividing the segments with extremities on lines  $d_1$  and  $d_3$  in a given ratio  $k$ . To obtain this plane, we take a point  $A \in d_1, B \in d_3$  and point  $C \in AB$  such that  $\frac{\|AC\|}{\|CB\|} = k$ . Through this point  $C$  we draw two parallel lines  $d_1$  and  $d_3$  which determine the above mentioned plane  $\alpha$ .

Let  $d_2 \cap \alpha = \{N\}$ . We must determine a segment that passes through  $N$  and with its extremities on  $d_1$  and  $d_3$ , respectively at  $M$  and  $P$ . As the required line passes through  $N$  and  $M$

$$\left. \begin{array}{l} N \in (N, d_1) \\ M \in (N, d_1) \end{array} \right\} \Rightarrow MN \subset (Nd_1) \quad (1)$$

The same line must pass through  $N$  and  $P$  and because

$$\left. \begin{array}{l} N \in (N, d_1) \\ P \in (N, d_3) \end{array} \right\} \Rightarrow NP \subset (Nd_3) \quad (2)$$

$M, N, P$  collinear.

From (1) and (2)

$$\Rightarrow MP \subset (N, d) \cap (N, d_3) \Rightarrow MP = (Nd_1) \cap (d_2N)$$

Then, according to previous problem 8:

$$\frac{\|MN\|}{\|NP\|} = k$$

and the required line is  $MP$ .

Solution to [Problem 215](#).

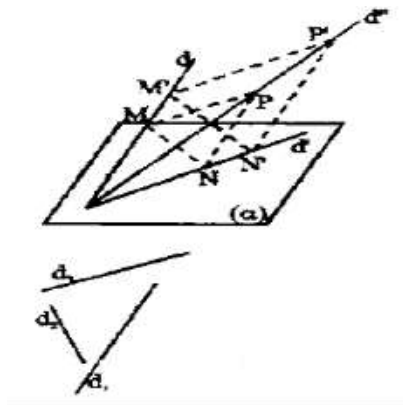

Let  $\Delta MNP$  such that

$$MP \parallel d_1, MN \parallel d_2, PN \parallel d_3. M \in d, N \in \alpha$$

Let  $\Delta M'N'P'$  such that

$$M' \in d, N' \in \alpha, M'P' \parallel d_1; M'N' \parallel d_2;$$

$$P'N' \parallel d_3.$$

Line  $MP$  generates a plane  $\beta$ , being parallel to a fixed direction  $d_1$  and it is based on a given line  $d$ . In the same way, the line  $MN$  generates a plane  $\gamma$ , parallel to a fixed direction  $d_2$ , and based on a given line  $d$ . As  $d$  is contained by  $\gamma \Rightarrow O$  is a common point for  $\alpha$  and  $\gamma \Rightarrow \alpha \cap \gamma \neq \emptyset \Rightarrow \alpha \cap \gamma = d', O \in d'$ .

$$\left. \begin{array}{l} N \in \alpha \\ N \in \gamma \end{array} \right\} \Rightarrow N \in \alpha \cap \gamma$$

( $\forall$ ) the considered  $\Delta$ , so  $N$  also describes a line  $d' \subset \alpha$ .

Because plane  $\gamma$  is well determined by line  $d$  and direction  $d_2$ , is fixed, so  $d' = \alpha \cap \gamma$  is fixed.

In the same way,  $PN$  will generate a plane  $\delta$ , moving parallel to the fixed direction  $d_3$  and being based on the given line  $d'$ .

As

$$\left. \begin{array}{l} O \in d' \\ O \in d \end{array} \right\} \Rightarrow \left\{ \begin{array}{l} O \in \beta \\ O \in \delta \end{array} \right. \Rightarrow \beta \cap \delta \neq \emptyset \Rightarrow O \in \beta \cap \delta = d''$$

$$\left. \begin{array}{l} P \in MP \Rightarrow P \in \beta \\ P \in PN \Rightarrow P \in \delta \end{array} \right\} \Rightarrow P \in \beta \cap \delta$$

( $\forall$ )  $P$  variable peak,  $P \in d''$ .

Thus, in the given conditions, for any  $\Delta MNP$ , peak  $P \in d''$ .

Vice-versa, let  $P' \in d''$ . On plane  $(d', d'')$  we draw  $P', M' \parallel PM \Rightarrow (M'P'N') \parallel (PMN) \Rightarrow (dd')$  the intersection of two parallel planes after parallel lines  $M'N' \parallel MN$  and the so constructed  $\Delta M'P'N'$  has its sides parallel to the three fixed lines, has  $M' \in d$  and  $N' \in \alpha$ , so it is one of the triangles given in the text.

So the locus is line  $d''$ . We've seen how it can be constructed and it passes through  $O$ .

In the situation when  $D \parallel \alpha$  we obtain

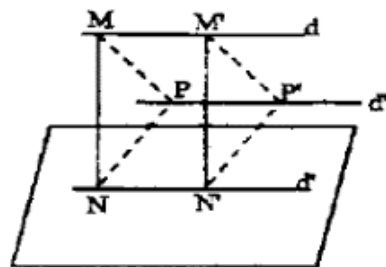

$$\left. \begin{array}{l} d \subset \beta \\ \delta' \subset \delta \\ d \parallel d' \end{array} \right\} \Rightarrow \beta \cap \delta = d'' \text{ și } d'' \parallel d$$

In this case the locus is a parallel line with  $d$ .

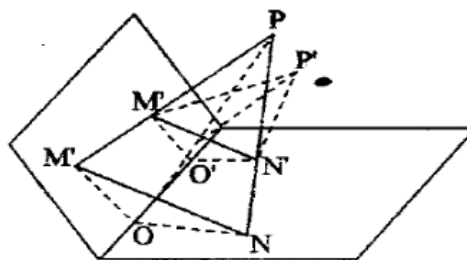

Let  $MNP$  and  $M'N'P'$  such that

$$\left. \begin{array}{lll} MP \parallel d_1 & M'P' \parallel d_1 & MP \parallel M'P' \\ MN \parallel d_2 & M'N' \parallel d_2 & MN \parallel M'N' \\ NP \parallel d_3 & N'P' \parallel d_3 & NP \parallel N'P' \end{array} \right\} \Rightarrow \Delta MNP \sim \Delta M'N'P' \Rightarrow$$

$$M \in \beta, N \in \alpha \quad M' \in \beta, N' \in \alpha$$

$$\Rightarrow (MNP) \parallel (M'N'P').$$

We assume  $\alpha \cap \beta = d$  and let  $d \cap (MNP) = \{O\}$  and  $d \cap (M'N'P') = \{O'\} \Rightarrow$

$$\left. \begin{aligned} (MNP) \cap \beta &= MO \\ (M'N'P') \cap \beta &= M'O' \end{aligned} \right\} \Rightarrow MO \parallel M'O'$$

a plane cuts the parallel planes after parallel lines.

In the same way,  $ON \parallel O'N'$  and because

$$MN \parallel M'N' \Rightarrow \triangle OMN \sim \triangle O'M'N'$$

$$\Rightarrow \left. \begin{aligned} \frac{\|OM\|}{\|O'M'\|} = \frac{\|ON\|}{\|O'N'\|} = \frac{\|MN\|}{\|M'N'\|} \\ \widehat{OMN} = \widehat{O'M'N'} \end{aligned} \right\} \Rightarrow \triangle MNP \sim M'N'P' \Rightarrow \left. \begin{aligned} \frac{\|MP\|}{\|M'P'\|} = \frac{\|MN\|}{\|M'N'\|} \\ \widehat{MNP} = \widehat{M'N'P'} \end{aligned} \right\} \Rightarrow$$

$$\Rightarrow \triangle OMP \sim O'M'P' \quad (1) \Rightarrow \begin{aligned} \widehat{MOP} &\equiv \widehat{M'O'P'} \\ \widehat{MPO} &\equiv \widehat{M'P'O'} \end{aligned}$$

We use the property: Let  $\pi_1$  and  $\pi_2$  2 parallel planes and  $A, B, C \in \pi_1$  and  $A'B'C' \in \pi_2$ ,  $AB \parallel A'B'$ ,

$$AC \parallel A'C', \widehat{A'B'C'} \equiv \widehat{A'B'C'}, \|AB\| = \|A'B'\|, \|AC\| = \|A'C'\|.$$

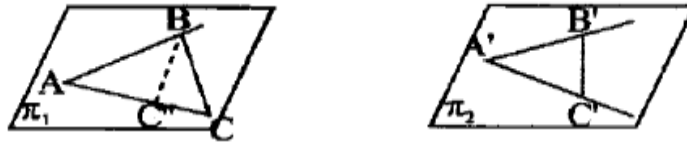

Let's show that  $BC \parallel B'C'$ . Indeed  $(BB'C')$  is a plane which intersects the 2 planes after parallel lines.

$$\Rightarrow \left. \begin{aligned} B'C' \parallel BC'' \\ AB \parallel A'B' \end{aligned} \right\} \Rightarrow \left. \begin{aligned} \widehat{ABC''} \equiv \widehat{A'B'C'} \\ \widehat{ABC} \equiv \widehat{A'B'C'} \end{aligned} \right\} \Rightarrow \widehat{ABC} \equiv \widehat{ABC''} \Rightarrow |BC| = |BC''| \Rightarrow B'C' \parallel BC.$$

Applying in (1) this property  $\Rightarrow OP \parallel O'P'$ . Maintaining  $OP$  fixed and letting  $P'$  variable, always  $OP \parallel O'P'$ , so  $O'P'$  generates a plane which passes through  $d$ . We assume  $\beta \parallel \alpha$ .

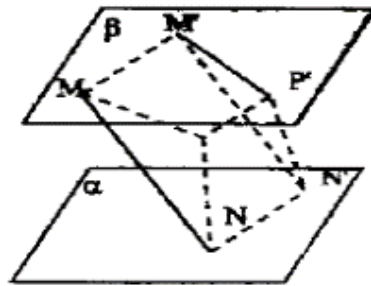

$$\left. \begin{aligned} \alpha \parallel \beta \\ MN \parallel M'N' \end{aligned} \right\} \Rightarrow |MN| \equiv |M'N'|$$

$MNN'M'$  parallelogram

$$\begin{aligned} &\Rightarrow MM' \parallel NN' \\ &\Rightarrow MM' \parallel (NN'P'P) \\ &\Rightarrow (\dot{M}PP'M') \cap (MN'P'P) = PP' \\ &PP' \parallel MM' \Rightarrow PP' \parallel NN' \end{aligned}$$

Considering  $P'$  fix and  $P$  variable  $\Rightarrow PP' \parallel \alpha$  and the set of parallel lines drawn  $PP' \parallel \beta$  to a plane through an exterior point is a parallel plane with the given plane.

So the locus is a parallel plane with  $\alpha$  and  $\beta$ .

Solution to [Problem 216](#).

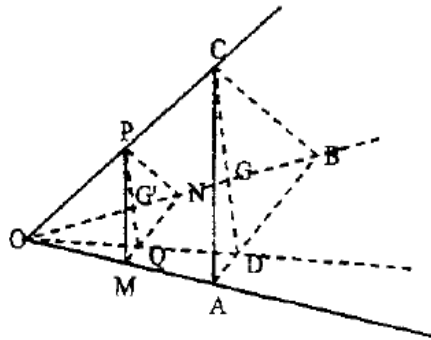

$$\begin{aligned} \|OM\| = \lambda \|OA\| &\Rightarrow \frac{\|OM\|}{\|OA\|} = \lambda; \|ON\| = \lambda \|OB\| \Rightarrow \frac{\|ON\|}{\|OB\|} = \lambda; \\ \|OP\| = \lambda \|OC\| &\Rightarrow \frac{\|OP\|}{\|OC\|} = \lambda \end{aligned}$$

In plane  $DAC$  we have:

$$\frac{\|OM\|}{\|OA\|} = \frac{\|OP\|}{\|OC\|} \Rightarrow PM \parallel AC.$$

In plane  $DAB$  we have:

$$\frac{\|OM\|}{\|OA\|} = \frac{\|ON\|}{\|OB\|} \Rightarrow MN \parallel AB.$$

In plane  $OBC$  we have:

$$\frac{\|ON\|}{\|OB\|} = \frac{\|OP\|}{\|OC\|} \Rightarrow PN \parallel BC.$$

From  $PM \parallel AC$  and  $PN \parallel BC \Rightarrow (MNR) \parallel (ABC)$ .

Let  $Q$  and  $D$  be midpoints of sides  $|MN|$  and  $|AB|$ .

$$\left. \begin{aligned} \triangle OMN \sim OAB &\Rightarrow \frac{\|OM\|}{\|OA\|} = \frac{\|MN\|}{\|AB\|} = \frac{\frac{1}{2}\|MN\|}{\frac{1}{2}\|AB\|} = \frac{\|MQ\|}{\|AB\|} \\ &\Rightarrow \triangle OMQ \sim OAD \Rightarrow \\ &\quad \widehat{OMQ} = \widehat{OAB} \end{aligned} \right\}$$

$$\Rightarrow \widehat{MOQ} = \widehat{AOD} \Rightarrow O, Q, D$$

are collinear.

Concurrent lines  $OD$  and  $OC$  determine a plane which cuts the parallel planes

$$\Rightarrow \left. \begin{array}{l} PQ \parallel CD \\ (OCD) \end{array} \right\} \Rightarrow \triangle OPQ \sim \triangle OCD \Rightarrow \frac{\|OP\|}{\|OC\|} = \frac{\|PQ\|}{\|CD\|} = \frac{\frac{2}{3}\|PQ\|}{\frac{2}{3}\|CD\|} = \frac{\|PG'\|}{\|CB\|} \Rightarrow$$

$$\Rightarrow \widehat{OPG'} \equiv \widehat{OCQ} \Rightarrow \triangle OPG' \sim \triangle OCQ \Rightarrow \widehat{POG'} \equiv \widehat{COG} \Rightarrow O, G', G$$

are collinear.

So  $G' \in |OG \Rightarrow$  the required locus is ray  $|OG$ .

*Vice-versa:* we take a point on  $|OG, G''$ , and draw through it a parallel plane to  $(ABC)$ , plane  $(M'', N'', P'')$ , similar triangles are formed and the ratios from the hypothesis appear.

Solution to [Problem 217](#).

Let  $A_2, B_2, C_2, D_2$  such that

$$\frac{\|AA_2\|}{\|A_2A_1\|} = \frac{\|BB_2\|}{\|B_2B_1\|} = \frac{\|CC_2\|}{\|C_2C_1\|} = \frac{\|DD_2\|}{\|D_2D_1\|} = k.$$

Mark on lines  $AD_1$  and  $BC_1$  points  $M$  and  $N$  such that

$$M \in |AD_1|, \frac{\|AM\|}{\|MD_1\|} = k$$

$$N \in |BC_1|, \frac{\|BN\|}{\|NC_1\|} = k$$

From

$$\frac{\|AA_2\|}{\|A_2A_1\|} = \frac{\|AM\|}{\|MD_1\|} = k \xrightarrow{\text{T.Tales}} A_2M \parallel A_1D_1 \quad (1)$$

$$A_2M \parallel A_1D_1 \Rightarrow \triangle AA_2M \sim \triangle AA_1D_1 \Rightarrow \frac{\|AA_2\|}{\|AA_1\|} = \frac{\|A_2M\|}{\|A_1D_1\|}$$

Next is

$$\frac{\|A_1M_1\|}{\|A_2D_1\|} = \frac{k}{k+1} \Rightarrow \|A_2M\| = \frac{k}{k+1}\|A_1D_1\| \quad (2)$$

The same,

$$\frac{\|BB_2\|}{\|B_2B_1\|} = \frac{\|BN\|}{\|NC_1\|} = k \Rightarrow B_2N \parallel B_1C_1 \quad (3)$$

$$B_2N \parallel B_1C_1 \Rightarrow \triangle BB_1N \sim \triangle BB_1C,$$

$$\Rightarrow \frac{\|BB_2\|}{\|BB_1\|} = \frac{\|B_2N\|}{\|B_1C_1\|}.$$

As

$$\frac{\|BB_2\|}{\|BB_1\|} = \frac{\|AA_2\|}{\|AA_1\|} = \frac{k}{k+1}$$

we obtain

$$\frac{\|B_2N\|}{\|B_1C_1\|} = \frac{k}{k+1} \Rightarrow \|B_2N\| = \frac{k}{k+1} \|B_1C_1\| \quad (4)$$

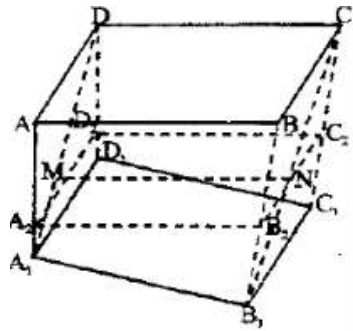

From

$$A_1D_1 \parallel B_1C_1 \Rightarrow \|A_1D_1\| \parallel \|B_1C_1\|$$

$$(1), (2), (3), (4) \Rightarrow A_2M \parallel B_2N \text{ și } \|A_2M\| = \|B_2N\| \Rightarrow A_2D_2NM$$

is a parallelogram.

$$\Rightarrow A_2B_2 \parallel MN, \|A_2B_2\| \parallel \|MN\| \Rightarrow D_2C_2NM$$

is parallelogram.

$$\Rightarrow D_2C_2 \parallel MN, \|D_2C_2\| \parallel \|MN\|$$

So

$$A_2B_2 \parallel D_2C_2 \text{ și } \|A_2D_2\| \parallel \|D_2C_2\| \Rightarrow A_2B_2C_2D_2$$

is a parallelogram.

Solution to [Problem 218](#).

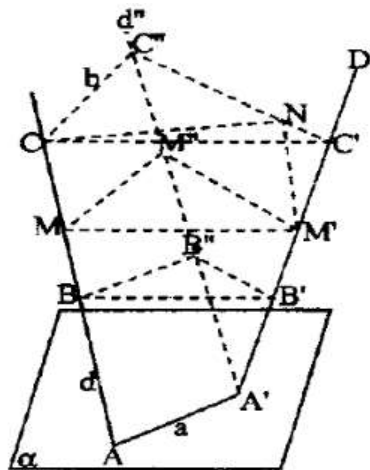

We draw through  $A'$  a line  $d'' \parallel d$ . We draw two parallel planes with  $\alpha$ , which will intersect the three lines in  $B', B^*, B$  and  $C', C^*, C$ . Plane  $(d, d^*)$  intersects planes  $\alpha$ ,  $(B'B^*B)$ ,  $(C'C^*C)$  after parallel lines

$$\left. \begin{array}{l} AA' \parallel BB^* \parallel CC^* \\ d \parallel d^* \end{array} \right\} \Rightarrow \|AA'\| = a =$$

$$= \|BB^*\| = \|C'C^*\|.$$

Plane  $(d', d^*)$  intersects parallel planes  $(B'B^*B)$ ,  $(C'C^*C)$  after parallel lines

$$\Rightarrow B'B^* \parallel C'C^*, BB^* \parallel CC^* \Rightarrow \widehat{B'B^*B} \equiv \widehat{C'C^*C}.$$

So  $(\forall)$  parallel plane with  $\alpha$  we construct, the newly obtained triangle has a side of  $\alpha$  length and the corresponding angle to  $\widehat{B'B^*B}$  is constant. We mark with a line that position of the plane, for which the opposite length of the required angle is  $l$ . With the compass spike at  $C$  and with a radius equal with  $l$ , we trace a circle arc that cuts segment  $|C'C^*|$  at  $N$  or line  $C'C^*$ . Through  $N$  we draw at  $(d', d^*)$  a parallel line to  $d^*$  which precisely meets  $d'$  in a point  $M'$ . Through  $M'$ , we draw the  $\parallel$  plane to  $\alpha$ , which will intersect the three lines in  $M, M', M^*$ .

$$\Rightarrow \left. \begin{array}{l} NM' \parallel C^*M^* \\ C^*N \parallel M^*M' \end{array} \right\} \Rightarrow M^*M'NC^*$$

is a parallelogram.

$$\Rightarrow \left. \begin{array}{l} \|NM'\| = \|C^*M^*\| \\ NM' \parallel C^*M \\ CM \parallel C^*M^* \\ \|CM\| = \|C^*M^*\| \end{array} \right\} \begin{array}{l} (1) \\ (2) \end{array} \left. \right\} NM' \parallel CM, \|NM'\| = \|CM\|$$

$\Rightarrow CNM'M$  is a parallelogram.

$$\Rightarrow \|MN'\| = \|CN\| = l$$

and line  $MM'$ , located in a parallel plane to  $\alpha$ , is parallel to  $\alpha$ .

*Discussion:*

Assuming the plane  $(C'C^*C)$  is variable, as  $|CC^*|$  and  $\widehat{C'C^*C}$  are constant, then  $d(C'C^*C) = b =$  also constant

If  $l < d$  we don't have any solution.

If  $l = d$   $(\exists)$  a solution, the circle of radius  $l$ , is tangent to  $C'C^*$ .

If  $l > d$   $(\exists)$  two solutions: circle of radius  $l$ , cuts  $C'C^*$  at two points  $N$  and  $P$ .



Solution to [Problem 219](#).

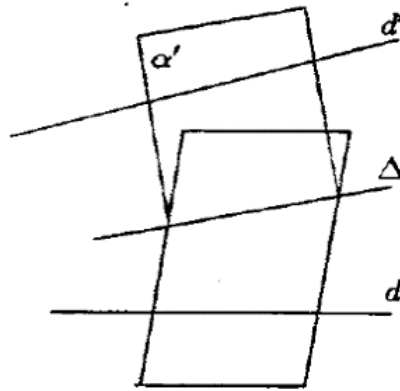

We draw through  $A$  planes  $\alpha \perp d$  and  $\alpha' \perp d'$ .

As  $A$  is a common point

$$\Rightarrow \alpha \cap \alpha' \neq \emptyset \Rightarrow$$

$$\Rightarrow \alpha \cap \alpha' = \Delta \Rightarrow A \in \Delta.$$

$$\left. \begin{array}{l} d \perp \alpha \Rightarrow d \perp \Delta \\ d' \perp \alpha' \Rightarrow d' \perp \Delta \end{array} \right\} \Rightarrow$$

$\Rightarrow \Delta$  the required line

If  $\alpha \neq \alpha'$  - we have only one solution.

If  $\alpha = \alpha'$  ( $\forall$ ) line from  $\alpha$  which passes through  $A$  corresponds to the problem, so

( $\exists$ ) infinite solutions.

Solution to [Problem 220](#).

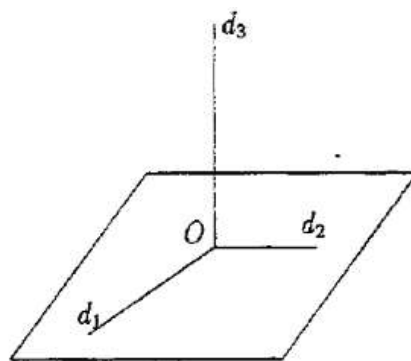

Let  $d_1 \perp d_2$  two concurrent perpendicular lines,  $d_1 \cap d_2 = \{O\}$ . They determine a plane  $\alpha = (d_1, d_2)$  and  $O \in \alpha$ . We construct on  $\alpha$  in  $O$ .

$$d_3 \perp \alpha, O \in d_3 \rightarrow d_3 \perp d_1, d_3 \perp d_2.$$

Solution to [Problem 221](#).

We use the reductio ad absurdum method.

Let  $d \perp a, d \perp b, d \perp c$ . We assume that these lines are not coplanar. Let  $\alpha = (b, c), \alpha' = (a, b), \alpha \neq \alpha'$ . Then  $d \perp \alpha, d \perp \alpha'$ .

Thus through point  $O$ , 2 perpendicular planes to  $d$  can be drawn. False  $\Rightarrow a, b, c$  are coplanar.

Solution to [Problem 222](#).

By reductio ad absurdum:

Let  $a \cap b \cap c \cap d = \{O\}$  and they are perpendicular two by two. From  $d \perp a, d \perp b, d \perp c \Rightarrow a, b, c$  are coplanar and  $b \perp a, c \perp a$ , so we can draw to point  $O$  two distinct perpendicular lines. False. So the 4 lines cannot be perpendicular two by two.

Solution to [Problem 223](#).

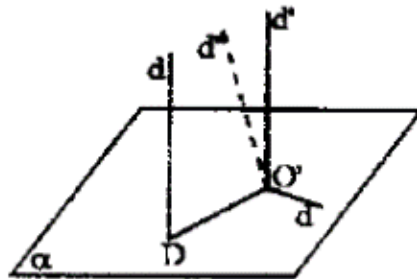

We assume that  $d \perp \alpha$ .

In  $d' \cap \alpha = \{O\}$  we draw line  $d'' \perp \alpha$ . Lines  $d'$  and  $d''$  are concurrent and determine a plane  $\beta = (d', d'')$  and as  $O' \in \beta, O' \in \alpha \Rightarrow$

$$\alpha \cap \beta = a \Rightarrow \begin{cases} a \subset \alpha & d'' \perp \alpha \Rightarrow d'' \perp a & (1) \\ a \subset \beta & \Rightarrow d' \perp a & (2) \end{cases}$$

From (1) and (2)  $\Rightarrow$  in plane  $\beta$ , on line  $a$ , at point  $O'$  two distinct perpendicular lines had been drawn. False. So  $d' \parallel \alpha$ .

Solution to [Problem 224](#).

$$\left. \begin{array}{l} d \perp \alpha \\ d' \perp \alpha \\ d \neq d' \end{array} \right\} \Rightarrow d \parallel d'$$

Reductio ad absurdum. Let  $d \not\parallel d'$ . We draw  $d'' \parallel d$  through  $O'$ .

$$\left. \begin{array}{l} d'' \parallel d \\ d \perp \alpha \end{array} \right\} \Rightarrow \left. \begin{array}{l} d'' \perp \alpha \\ d' \perp \alpha \end{array} \right\} \Rightarrow$$

$\Rightarrow$  at point  $O'$  we can draw two perpendicular lines to plane  $\alpha$ . False.

So  $d \parallel d'$ .

Solution to [Problem 225](#).

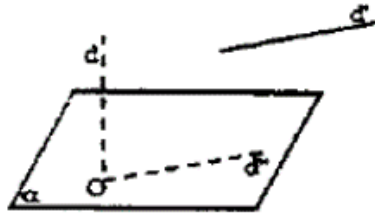

Let  $d \perp \alpha$  and  $d \cap \alpha = \{O\}$ . We draw through  $O$  a parallel to  $d'$ , which will be contained in  $\alpha$ , then  $d \parallel \alpha$ .

$$d' \parallel d, O \in d'' \Rightarrow d'' \subset \alpha, d \perp \alpha \Rightarrow d \perp d'' \Rightarrow d \perp d'.$$

Solution to [Problem 226](#).

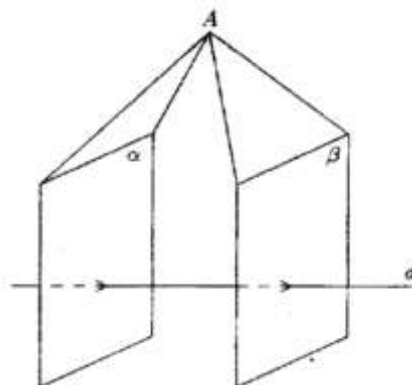

We assume  $\beta \Rightarrow \alpha \cap \beta \neq \emptyset$  and let  $A \in \alpha \cap \beta \Rightarrow$  through a point  $A$  there can be drawn two distinct perpendicular planes on this line. False.

$$\Rightarrow \alpha \parallel \beta.$$

Solution to [Problem 227](#).

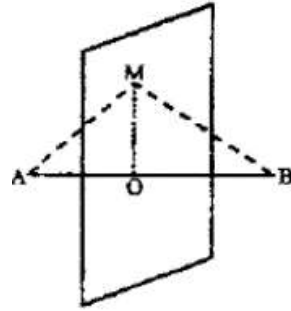

Let  $M$  be a point in space with the property  $\|MA\| = \|MB\|$ .

We connect  $M$  with the midpoint of segment  $[AB]$ , point  $O$ .

$$\Rightarrow \triangle AMO = \triangle BMO \Rightarrow MO \perp AB.$$

So  $M$  is on a line drawn through  $O$ , perpendicular to  $AB$ .

But the union of all perpendicular lines drawn through  $O$  to  $AB$  is the perpendicular plane to  $AB$  at point  $O$ , marked with  $\alpha$ , so  $M \in \alpha$ .

*Vice-versa:* let  $M \in \alpha$ ,

$$d = AB \perp \alpha \Rightarrow d \perp MO$$

$$\left. \begin{array}{l} |AO| \equiv |OB| \\ |MO| \text{ common side} \\ MO \perp AB \end{array} \right\} \Rightarrow \triangle AMO \equiv \triangle BMO \Rightarrow \|MA\| = \|MB\|.$$

Solution to [Problem 228](#).

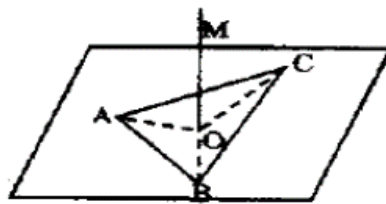

Let  $M$  be a point in space with this property:

$$\|MA\| = \|MB\| = \|MC\|$$

Let  $O$  be the center of the circumscribed circle  $\triangle ABC \Rightarrow \|OA\| = \|OB\| = \|OC\|$ , so  $O$  is also a point of the desired locus.

According to the previous problem the locus of the points in space equally distant from  $A$  and  $B$  is in the mediator plane of segment  $[AB]$ , which also contains  $M$ . We mark with  $\alpha$  this plane. The locus of the points in space equally distant from  $B$  and  $C$  is in the mediator plane of segment  $[BC]$ , marked  $\beta$ , which contains both  $O$  and  $M$ . So  $\alpha \cap \beta = OM$ .

$$\left. \begin{array}{l} AB \perp \alpha \Rightarrow AB \perp OM \\ BC \perp \alpha \Rightarrow BC \perp OM \end{array} \right\} \Rightarrow OM \perp (ABC)$$

so  $M \in$  the perpendicular line to plane  $(ABC)$  in the center of the circumscribed circle  $\Delta ABC$ .

*Vice-versa*, let  $M \in$  this perpendicular line

$$\left. \begin{array}{l} OM \perp OA \\ OM \perp OB \\ OM \perp OC \\ \|OA\| = \|OB\| = \|OC\| \end{array} \right\} \Rightarrow \Delta OMA \equiv \Delta OMB \equiv \Delta OMC \Rightarrow \|AM\| = \|BM\|$$

$= \|CM\|$ , so  $M$  has the property from the statement.

Solution to [Problem 229](#).

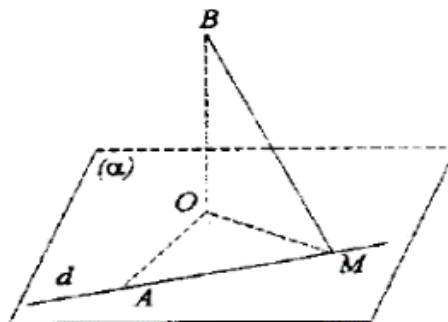

We draw  $\perp$  from  $B$  to the plane. Let  $O$  be the foot of this perpendicular line.

Let

$$\left. \begin{array}{l} BM \perp d \\ BO \perp \alpha \end{array} \right\} \Rightarrow MO \perp d \Rightarrow$$

$$\Rightarrow m(\widehat{OMA}) = 90^\circ \Rightarrow M \in$$

the circle of radius  $OA$ . *Vice-versa*, let  $M \in$  this circle

$$\Rightarrow OM \perp AM, BO \perp \alpha \Rightarrow BM \perp AM \Rightarrow BM \perp d,$$

so  $M$  represents the foot from  $B$  to  $AM$ .

Solution to [Problem 230](#).

Let  $\alpha$  be a plane that passes through  $a$  and let  $M$  be the  $\perp$  foot from  $A$  to  $\alpha \Rightarrow AM \perp \alpha$ .

From

$$\left. \begin{array}{l} AM \perp \alpha \\ AA' \perp a \end{array} \right\} \Rightarrow MA' \perp a,$$

so  $M \in$  a perpendicular line to  $a$  in  $A'$ , thus it is an element of the perpendicular plane to  $a$  in  $A'$ , which we mark as  $\pi$  and which also contains  $A$ .

$$AM \perp \alpha \Rightarrow AM \perp MA' \Rightarrow$$

$M \in$  the circle of radius  $AA'$  from plane  $\pi$ .

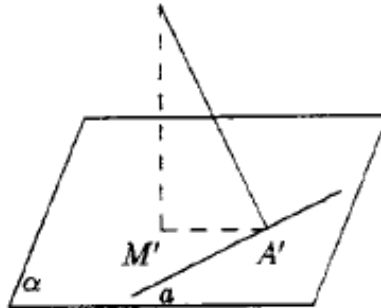

*\*Vice-versa*, let  $M$  be a point on this circle of radius  $AA'$  from plane  $\pi$ .

$$\left. \begin{array}{l} MA' \perp a \\ AA' \perp a \\ AM \perp MA' \end{array} \right\} \Rightarrow AM \perp (M, a)$$

$\Rightarrow M$  is the foot of a  $\perp$  drawn from  $A$  to a plane that passes through  $a$ .

Solution to [Problem 231](#).

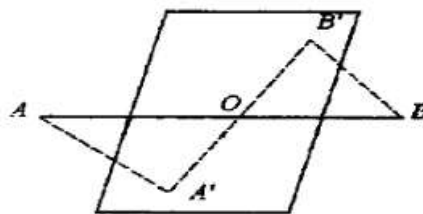

Let  $A'$  and  $B'$  be the feet of the perpendicular lines from  $A$  and  $B$  to  $\alpha$

$$\left. \begin{array}{l} AA' \perp \alpha \\ BB' \perp \alpha \end{array} \right\} \Rightarrow AA' \parallel BB' \Rightarrow$$

$(\exists)$  a plane  $\beta = (AA', BB')$  and  $AB \subset \beta$

$$\Rightarrow \left. \begin{array}{l} O \in \beta \\ O \in \alpha \end{array} \right\} \Rightarrow O \in \alpha \cap \beta = A'B' \Rightarrow O, A', B'$$

are collinear.

In plane  $\beta$  we have

$$\left. \begin{array}{l} \|OA\| = \|OB\| \\ \widehat{AOA'} \equiv \widehat{BOB'} \\ \Delta \text{ right} \end{array} \right\} \Rightarrow \Delta AOA' \equiv BOB' \Rightarrow \|AA'\| = \|BB'\|$$

Solution to [Problem 232](#).

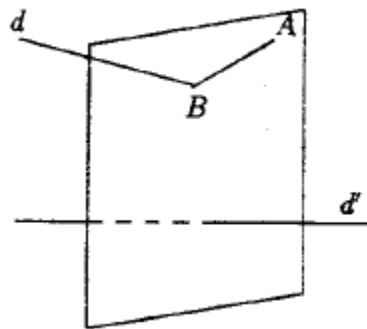

Let  $d, d'$  be given lines,  $A$  given point. We draw through  $A$  plane  $\alpha \perp$  to  $d'$ .

If  $a \cap \alpha = \{B\}$ , then line  $AB$  is the desired one, because it passes through  $A$ , meets  $d$  and from  $d' \alpha d' AB$ . If  $d \cap \alpha = \emptyset$  there is no solution.

If  $d \subset \alpha$ , then any line determined by  $A$  and a point of  $d$  represents solution to the problem, so there are infinite solutions.

Solution to [Problem 233](#).

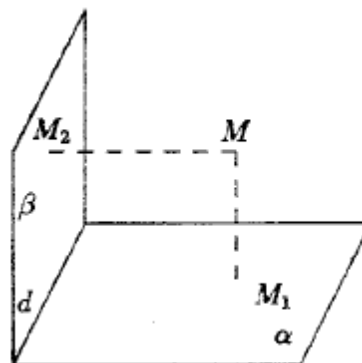

$$\alpha \cap \beta = d \Rightarrow \begin{cases} d \subset \alpha \\ d \subset \beta \end{cases}$$

$$\left. \begin{array}{l} MM_1 \perp \alpha \Rightarrow MM_1 \perp d \\ MM_2 \perp \beta \Rightarrow MM_2 \perp d \end{array} \right\} \Rightarrow d \perp (MM_1M_2)$$

Solution to [Problem 234](#).

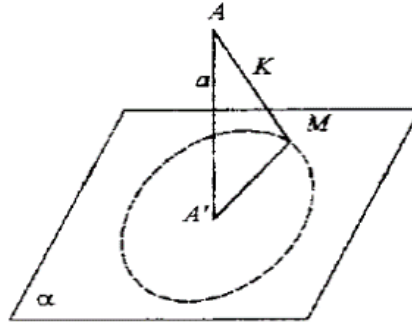

Let  $M$  be a point such that  $\|AM\| = k$ .

We draw  $AA' \perp \alpha \Rightarrow A'$  fixed point and  $AA' \perp A'M$ .

We write  $\|AA'\| = a$ .

Then

$$\left. \begin{array}{l} \|AM\| = \sqrt{k^2 - a^2} = ct \\ A^2 - \text{fix} \end{array} \right\} \Rightarrow$$

$M \in$  a circle centered at  $A'$  and of radius  $\sqrt{k^2 - a^2}$ , for  $k > a$ .

For  $k = a$  we obtain 1 point.

For  $k < a$  empty set.

Vice-versa, let  $M$  be a point on this circle  $\Rightarrow$

$$\left. \begin{array}{l} \|A'M\| = \sqrt{k^2 - a^2} \\ \|AA'\| = a \end{array} \right\} \Rightarrow \|AM\| =$$

$$= \sqrt{k^2 - a^2 + a^2} = k$$

so  $M$  has the property from the statement.

Solution to [Problem 235](#).

$$1) \|AB\| = \sqrt{a^2 + b^2}; \|BC\| = \sqrt{b^2 + c^2}, \|CA\| = \sqrt{a^2 + c^2}$$

$$2) \left. \begin{array}{l} OM \perp AB \\ CO \perp (OAB) \end{array} \right\} \Rightarrow CM \perp AB$$



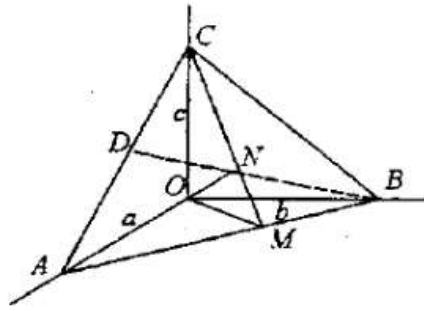

In  $\triangle OCM$ :

$$\|CM\| = \sqrt{c^2 + \frac{a^2b^2}{a^2+b^2}} = \sqrt{\frac{c^2a^2 + c^2b^2 + a^2b^2}{a^2+b^2}}$$

$$\sigma[ABC] = \frac{\|AB\| \cdot \|CM\|}{2} = \sqrt{\frac{a^2+b^2}{2}} \times$$

$$\times \sqrt{\frac{a^2c^2 + c^2b^2 + a^2b^2}{a^2+b^2}} \Rightarrow$$

$$\Rightarrow \sigma^2[ABC] = \frac{a^2b^2 + a^2c^2 + b^2c^2}{4}$$

But

$$\sigma[OAB] = \frac{ab}{2}$$

$$\alpha[BOC] = \frac{bc}{2}; \sigma[COA] = \frac{ac}{2}$$

$$\sigma^2[ABC] = \frac{a^2b^2}{4} + \frac{a^2c^2}{4} + \frac{b^2c^2}{4} = \sigma^2[AOB] + \sigma^2[DOC] + \sigma^2[COA]$$

3. Let  $H$  be the projection of  $O$  lcp. plane  $ABC$ , so

$$OH \perp (ABC) \Rightarrow OH \perp AC$$

$$\left. \begin{array}{l} OC \perp DA \\ OC \perp OB \end{array} \right\} \Rightarrow OC \perp (OAB) \Rightarrow OC \perp AB$$

$$\Rightarrow AB \perp (OHC) \Rightarrow AB \perp CH \Rightarrow$$

$H \in$  corresponding heights of side  $AB$ . We show in the same way that  $AC \perp BH$  and thus  $H$  is the point of intersection of the heights, thus orthocenter.

$$4) \|OH\| \cdot \|CM\| = \|OC\| \cdot \|OM\| \Rightarrow OH \cdot \sqrt{\frac{a^2c^2 + c^2b^2 + b^2a^2}{a^2+b^2}} = \frac{ab}{\sqrt{a^2+b^2}} \Rightarrow$$

$$\Rightarrow \|OH\| = \frac{\frac{cab}{\sqrt{a^2+b^2}}}{\frac{\sqrt{a^2c^2 + c^2b^2 + b^2a^2}}{\sqrt{a^2+b^2}}} = \frac{abc}{\sqrt{a^2b^2 + a^2c^2 + b^2c^2}}$$

Solution to [Problem 236](#).

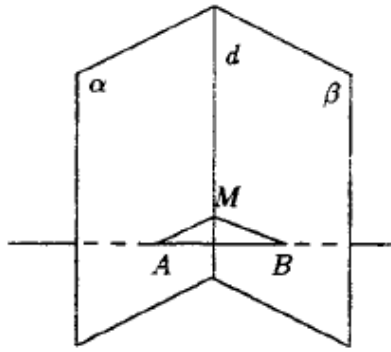

First we prove that if a line is  $\perp$  to two concurrent planes  $\Rightarrow$  the planes coincide.

$$\left. \begin{array}{l} a \perp \alpha \\ a \perp \beta \\ \alpha \cap \beta = a \end{array} \right\} \Rightarrow \alpha = \beta.$$

Let

$$A = a \cap \alpha, B = a \cap \beta, M \in d.$$

$$\left. \begin{array}{l} a \perp \alpha \Rightarrow a \perp AM \\ a \perp \beta \Rightarrow a \perp BM \end{array} \right\} \Rightarrow \triangle ABM$$

$\triangle ABM$  has two right angles. False. We return to the given problem.

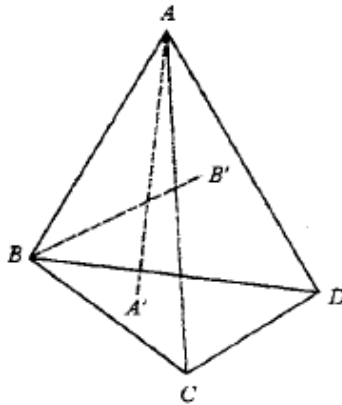

$$\left. \begin{array}{l} AA' \perp (BCD) \Rightarrow AA' \perp CD \\ BB' \perp (ACD) \Rightarrow BB' \perp CD \end{array} \right\} \Rightarrow CD \perp (AA', BB')$$

being concurrent, they determine a plane  $\Rightarrow CD \perp AB$ .

$$CC' \perp (ABD) \Rightarrow CC' \perp AB$$

$$DD' \perp (ABC) \Rightarrow DD' \perp AB$$

$$\left. \begin{array}{l} AB \perp CD \\ AB \perp DD' \end{array} \right\} \Rightarrow AB \perp (CDD') \\ \left. \begin{array}{l} AB \perp CD \\ AB \perp CC' \end{array} \right\} \Rightarrow AB \perp (CDC') \\ \left. \begin{array}{l} (CDD') \cap (CDC') = CD \end{array} \right\}$$

$C, D, C', D'$  are coplanar  $\Rightarrow CC'$  and  $DD'$  are coplanar.

Solution to [Problem 237](#).

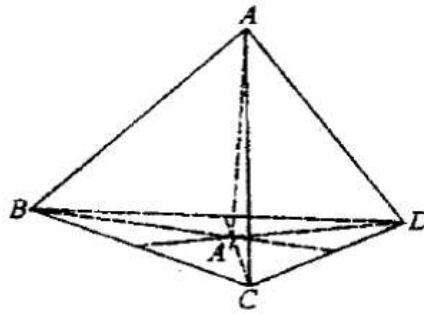

We draw

$$\left. \begin{array}{l} AA' \perp (BCD) \\ AA' \perp BC \\ AB \perp DC \end{array} \right\} \Rightarrow DC \perp (ABA') \Rightarrow DC \perp BA'$$

$\Rightarrow BA'$  height in  $\triangle BCD$  (1)

$$\left. \begin{array}{l} AA' \perp BD \\ AC \perp BD \end{array} \right\} \Rightarrow BD \perp (AA'C) \Rightarrow BD \perp A'C$$

$\Rightarrow A'C$  height in  $\triangle ABC$  (2)

From (1) and (2)  $\Rightarrow A'$  is the orthocenter  $\triangle ABC \Rightarrow OA' \perp BC$ .

$$\left. \begin{array}{l} DA' \perp BC \\ AA' \perp BC \end{array} \right\} \Rightarrow BC \perp (DAA') \Rightarrow BC \perp AD$$

Solution to [Problem 238](#).

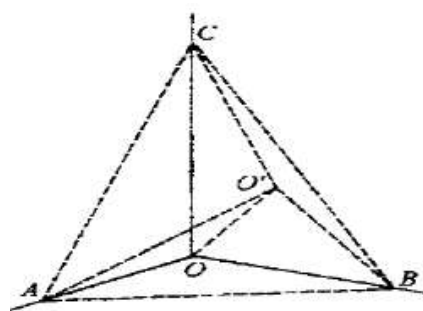

Let

$$\left. \begin{array}{l} OO' \perp (ABC) \Rightarrow OO' \perp AO' \\ OO' \perp BO' \\ OO' \perp CO' \end{array} \right\} \Rightarrow \triangle AOO',$$

$\triangle BOO'$  and  $\triangle COO'$  are right at  $O'$ .

As  $\left. \begin{array}{l} |OA| \equiv |OB| \equiv |OC| \\ |OO'| \text{ common side} \end{array} \right\} \\ \Rightarrow \triangle AOO' \equiv \triangle BOO' \equiv \triangle COO' \\ \Rightarrow ||OA|| = ||BO'|| = ||CO'|| \Rightarrow O'$   
is the center of the circumscribed circle  $\triangle ABC$ .

Solution to [Problem 239](#).

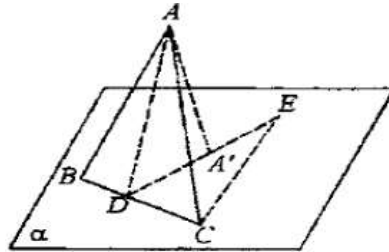

Let  $D$  be the midpoint of  $[BC]$  and  $E \in |DA'|$  such that  $||DE|| = ||DA||$ .

$AD$  is median in the  $\triangle$  isosceles

$$\left. \begin{array}{l} \Rightarrow AD \perp BC \\ AA' \perp \alpha \end{array} \right\} \Rightarrow A'D \perp BC$$

$$\left. \begin{array}{l} |AD| \equiv |DE| \\ |DC| \text{ common} \end{array} \right\} \Rightarrow \triangle ADC \equiv \triangle DCE \Rightarrow \widehat{DAC} \equiv \widehat{DEC}$$

$$\widehat{DA'C} > \widehat{DEC}$$

being external for

$$\triangle CA'E \Rightarrow \widehat{DAC} > \widehat{BAC} \Rightarrow 2\widehat{DA'C} > 2\widehat{DAC} \Rightarrow \widehat{BA'C} > \widehat{BAC}.$$

Solution to [Problem 240](#).

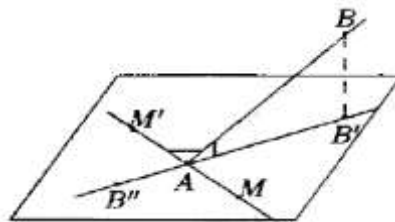

Let  $M$  be a point in the plane and  $|AM'|$  the opposite ray to  $AM$ .

According to theorem 1

$$\Rightarrow \widehat{B'AB} < \widehat{MAB} \Rightarrow$$

$$\Rightarrow m(\widehat{B'AB}) < m(\widehat{MAB}) \Rightarrow m(\widehat{B'AB}) < m(\widehat{M'AB}) \Rightarrow$$

$$\Rightarrow -m(\widehat{B'AB}) > -m(\widehat{M'AB}) \Rightarrow$$

$$\Rightarrow 180^\circ - m(\widehat{B'AB}) > 180^\circ - m(\widehat{M'AB}) \Rightarrow m(\widehat{B''AB}) > m(\widehat{MAB}) \Rightarrow \widehat{B''AB} > \widehat{MAB}.$$

Solution to [Problem 241](#).

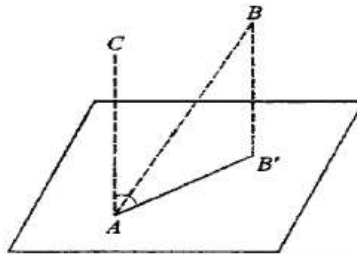

We construct  $B$  on the plane

$$\left. \begin{array}{l} \Rightarrow BB' \perp \alpha \\ AC \perp \alpha \end{array} \right\} \Rightarrow$$

$\Rightarrow AC$  and  $BB'$  determine a plane  $\beta = (AC, BB') \Rightarrow AB \subset \beta$  and on this plane  $m(\widehat{CAB}) = 90^\circ - m(\widehat{BAB'})$ .

Solution to [Problem 242](#).

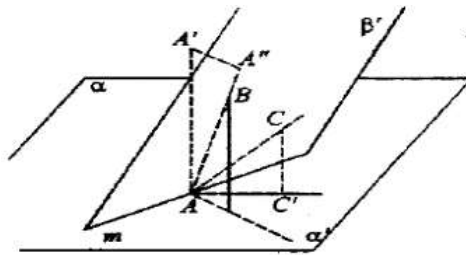

Let ray  $AB \subset \beta'$  such that  $AB \perp m$ . Let  $AC$  another ray such that  $AC \subset \beta'$ . We draw  $BB' \perp \alpha$  and  $CC' \perp \alpha$  to obtain the angle of the 2 rays with  $\alpha$ , namely  $\widehat{BAB'} > \widehat{CAC'}$ . We draw line  $AA'$  such that  $AA' \perp \alpha$  and is on the same side of plane  $\alpha$  as well as half-plane  $\beta'$ .

$$\left. \begin{array}{l} AA' \perp \alpha \Rightarrow AA' \perp m \\ AB \perp m \\ A'A'' \perp AB \end{array} \right\} \Rightarrow A'A'' \perp \beta' \Rightarrow$$

$AB$  is the projection of ray  $AA'$  on plane  $\beta$

$$\beta \stackrel{t.t.}{\Rightarrow} \widehat{A'AB} < \widehat{A'AC} \Rightarrow m(\widehat{A'AB}) < m(\widehat{A'AC}) \Rightarrow -m(\widehat{A'AB}) > -m(\widehat{A'AC}) \Rightarrow 90^\circ - m(\widehat{A'AB}) > 90^\circ - m(\widehat{A'AC}) \Rightarrow \widehat{BAB'} > \widehat{CAC'}$$

Solution to [Problem 243](#).

Let  $d$  be the border of  $\alpha'$  and  $A \in d$ . We draw a plane  $\perp$  on  $d$  in  $A$ , which we mark as  $\gamma$ .

$$\left. \begin{array}{l} \gamma \cap c = c \\ d \perp \gamma \end{array} \right\} \Rightarrow d \perp c$$

In this plane, there is only one ray  $b$ , with its origin in  $A$ , such that  $m(\widehat{c, b}) = a$ .

The desired half-plane is determined by  $d$  and ray  $b$ , because from

$$\left. \begin{array}{l} d \perp \gamma \Rightarrow d \perp b \\ d \perp c \end{array} \right\} \Rightarrow m(\alpha' \beta') = m(\widehat{b, c}) = a.$$

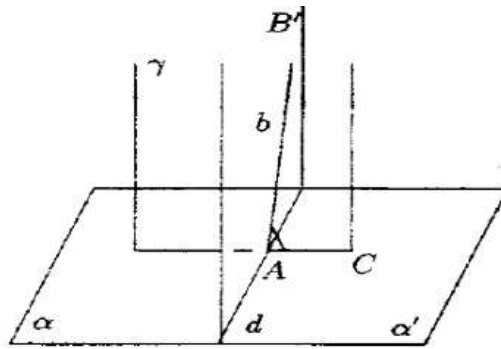

Solution to [Problem 244](#).

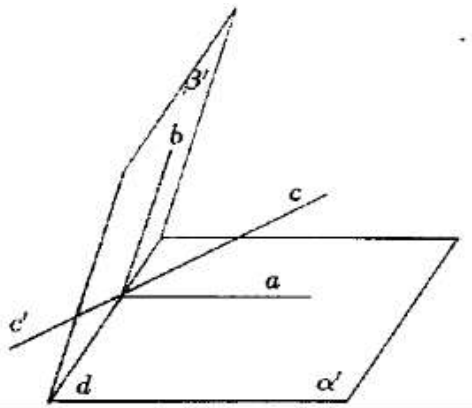

Let  $d$  be the edge of the dihedral angle and  $A \in d$ . We draw  $a \perp d, a \subset \alpha'$  and  $b \perp d, b \subset \beta'$  two rays with origin in  $A$ . It results  $d \perp (ab)$ . We draw on plane  $(a, b)$  ray  $c$  such that  $m(\widehat{ac}) = m(\widehat{cb})$  (1).

$$\text{As } d \perp (ab) \Rightarrow d \perp c.$$

Half-plane  $\gamma' = (d, c)$  is the desired one, because

$$\left. \begin{array}{l} m(\alpha' \gamma') = m(\widehat{a, c}) \\ m(\gamma' \beta') = m(\widehat{c, b}) \end{array} \right\} \Rightarrow (\alpha' \gamma') = m(\gamma' \beta').$$

If we consider the opposite ray to  $c, c'$ , half-plane  $\gamma'' = (d, c')$  also forms concurrent angles with the two half-planes, being supplementary to the others.

Solution to [Problem 245](#).

Let  $M$  be a point in space equally distant from the half-planes  $\alpha', \beta' \Rightarrow |MA| = |MB|$ .

$$\left. \begin{array}{l} MA \perp \alpha \Rightarrow MA \perp d \\ MB \perp \beta \Rightarrow MB \perp d \end{array} \right\} \Rightarrow d \perp (MAB),$$

where  $d = \alpha \cap \beta$ .

Let

$$\begin{aligned} d \cap (MAB) &= \{O\} \Rightarrow \\ \left. \begin{array}{l} d \perp OA \\ d \perp OB \end{array} \right\} &\Rightarrow m(\alpha' \beta') = \\ &= m(\widehat{AOB}). \end{aligned}$$

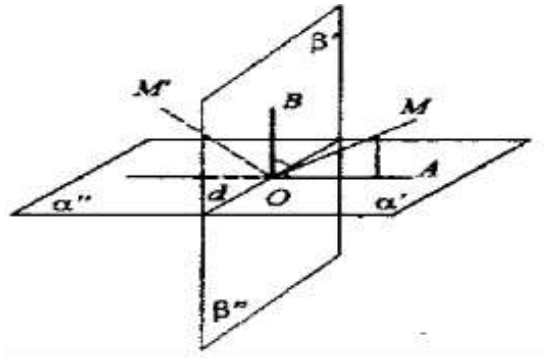

$$\begin{aligned} &\left. \begin{array}{l} |MA| = |MB| \\ |OM| \text{ common side} \end{array} \right\} \Rightarrow \\ &\Rightarrow \triangle MOA \equiv \triangle MOB \Rightarrow \widehat{MOA} \equiv \widehat{MOB} \Rightarrow \\ &\Rightarrow M \in \text{bisector of the angle.} \end{aligned}$$

$\widehat{ADB} \Rightarrow M \in \text{bisector half-plane of the angle of half-planes } \alpha', \beta'$ .

If  $M'$  is equally distant from half-planes  $\beta'$  and  $\alpha''$  we will show in the same way that  $M' \in \text{bisector half-plane of these half-planes}$ . We assume that  $M$  and  $M'$  are on this plane  $\perp$  to  $d$ , we remark that  $m(\widehat{MOM'}) = 90^\circ$ , so the two half-planes are  $\perp$ . Considering the two other dihedral angles, we obtain 2 perpendicular planes, the 2 bisector planes.

*Vice-versa:* we can easily show that a point on these planes is equally distant from planes  $\alpha$  and  $\beta$ .

Solution to [Problem 246](#).

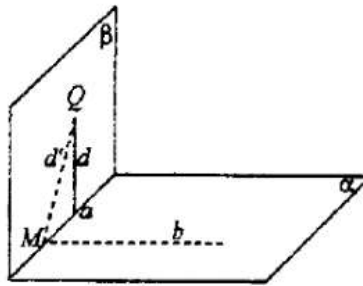

$$\left. \begin{array}{l} \alpha \perp \beta \\ Q \in \beta \\ d \perp \alpha \\ Q \in d \end{array} \right\} \Rightarrow d \subset \beta.$$

Let  $\alpha \cap \beta = \alpha$ . In plane  $\beta$  we draw

$$d' \perp \alpha, Q \in d'.$$

As

$$\left. \begin{array}{l} \alpha \perp \beta \Rightarrow m(\widehat{d'b}) = 90^\circ \Rightarrow d' \perp b \\ d' \perp a \end{array} \right\}$$

but

$$\left. \begin{array}{l} d' \perp \alpha \\ d \perp \alpha \end{array} \right\} \Rightarrow d = d'$$

so from a point it can be drawn only one perpendicular line to a plane,

$$d' \subset \beta \Rightarrow d \subset \beta.$$

Solution to [Problem 247](#).

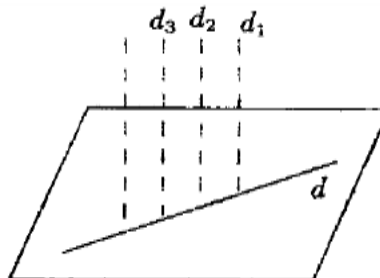

Let

$$\left. \begin{array}{l} d_1 \perp \alpha \\ d_2 \perp \alpha \\ d_3 \perp \alpha \end{array} \right\} \Rightarrow d_1 \parallel d_2 \parallel d_3 \Rightarrow$$



the line with the same direction. We know that the union of the lines with the same direction and are based on a given line is a plane. As this plane contains a perpendicular line to  $\alpha$ , it is perpendicular to  $\alpha$ .

Solution to [Problem 248](#).

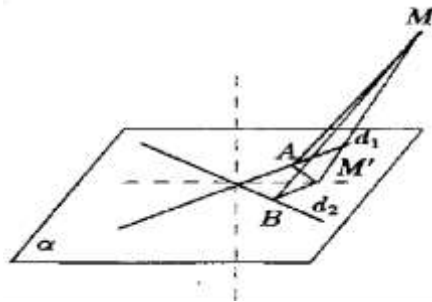

Let  $\alpha = (d_1, d_2)$  the plane of the two concurrent lines and  $M$  is a point with the property  $d(M, d_1) = d(M, d_2)$ . We draw

$$MA \perp d_1, MB \perp d_2 \Rightarrow \|MA\| = \|MB\|.$$

Let

$$M' = \text{pr}_\alpha M \Rightarrow \triangle MAM' \cong \triangle MBM' \Rightarrow \|M'A\| =$$

$$\|M'B\| \Rightarrow M' \in$$

a bisector of the angle formed by the two lines, and  $M$  is on a line  $\alpha$  which meets a bisector  $\Rightarrow M \in$  a plane  $\perp \alpha$  and which intersects  $\alpha$  after a bisector. Thus the locus will be formed by two planes  $\perp \alpha$  and which intersects  $\alpha$  after the two bisectors of the angle formed by  $d_1, d_2$ . The two planes are  $\perp$ .

$$\Rightarrow \left. \begin{array}{l} \|M'A\| = \|M'B\| \\ \|MM'\| \text{ common side} \end{array} \right\} \Rightarrow MA \perp d_1$$

And in the same way  $MB \perp d_2 \Rightarrow M$  has the property from the statement.

Solution to [Problem 249](#).

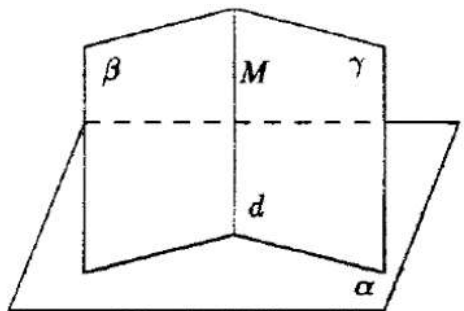

Let  $\beta \cap \gamma = d$  and  $M \in d \Rightarrow M \in \beta, M \in \gamma$ . We draw  $\perp$  from  $M$  to  $\alpha$ , line  $d'$ .

According to a previous problem

$$\Rightarrow \left. \begin{array}{l} d' \subset \beta \\ d' \subset \alpha \end{array} \right\} \Rightarrow d' \perp \alpha.$$

Solution to [Problem 250](#).

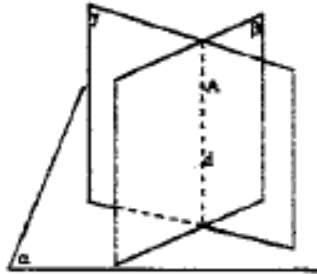

Let  $\beta$  and  $\gamma$  be such planes, that is

$$A \in \beta, \beta \perp \alpha$$

$$A \in \gamma, \gamma \perp \alpha$$

From

$$\left. \begin{array}{l} A \in \beta \\ A \in \gamma \end{array} \right\} \Rightarrow \beta \cap \gamma \neq \emptyset \Rightarrow$$

are secant planes and  $\perp$  to  $\alpha$ .

$$\alpha \xrightarrow{\text{Pr.1}} \alpha \perp (\beta \cap \gamma) = d, A \in d.$$

So their intersection is  $\perp$  through  $A$  to plane  $\alpha$ .

Solution to [Problem 251](#).

We construct the point on the two planes and the desired plane is determined by the two perpendicular lines.

Solution to [Problem 252](#).

Let  $\alpha \cap \beta = d$  and  $M \in d$ . We consider a ray originating in  $M$ ,  $a \in \alpha$  and we construct a  $\perp$  plane to  $a$  in  $M$ , plane  $\gamma$ .

Because

$$\left. \begin{array}{l} M \in \beta \\ M \in \gamma \end{array} \right\} \Rightarrow \beta \cap \gamma \neq \emptyset$$

and let a ray originating in  $M$ ,  $b \subset \beta \cap \gamma \Rightarrow b \subset \beta, b \subset \gamma$ . As  $a \perp \gamma \Rightarrow a \perp b$  and the desired plane is that determined by rays  $(a, b)$ .

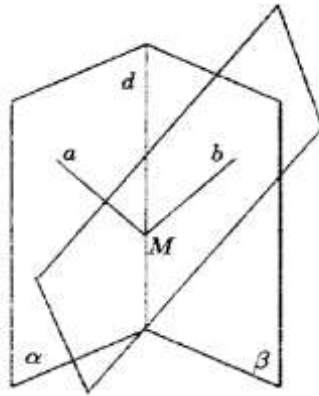

Solution to [Problem 253](#).

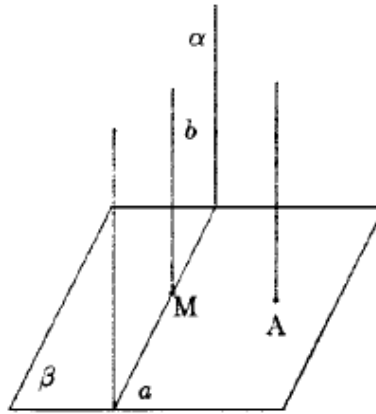

Let  $\alpha \cap \beta = a$  and  $d \cap \beta = \{A\}$ .

We suppose that  $A \notin a$ . Let  $M \in a$ , we build  $b \perp \beta, M \in b \Rightarrow b \subset \alpha$ .

$$b \perp \beta, d \perp \beta \Rightarrow d \parallel b \Rightarrow d \parallel \alpha.$$

If

$$\left. \begin{array}{l} A \in a \\ d \perp \beta \end{array} \right\} \Rightarrow d \subset \alpha.$$

Solution to [Problem 254](#).

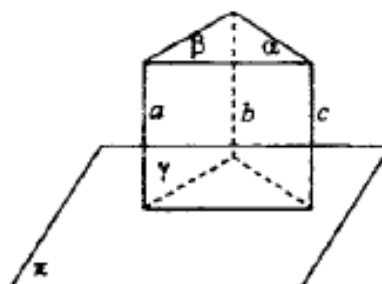

$$\alpha \cap \gamma = b$$

$$\alpha \cap \beta = c$$

$$\gamma \cap \beta = a$$

$$\left. \begin{array}{l} \pi \perp \alpha \\ \pi \perp \beta \end{array} \right\} \Rightarrow \pi \perp c \quad (1)$$

$$\left. \begin{array}{l} \pi \perp \alpha \\ \pi \perp \gamma \end{array} \right\} \Rightarrow \pi \perp b \quad (2)$$

$$\left. \begin{array}{l} \pi \perp \beta \\ \pi \perp \gamma \end{array} \right\} \Rightarrow \pi \perp a \quad (3)$$

From (1), (2), (3)  $\Rightarrow a \parallel b \parallel c$ .

Solution to [Problem 255](#).

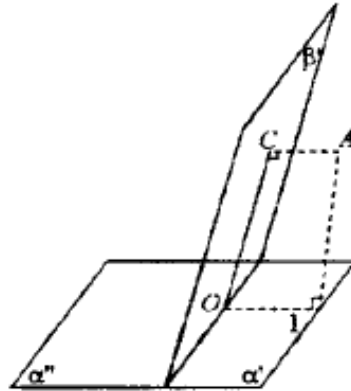

Let  $A \in \text{int.}(\widehat{\alpha'\beta'})$ ,  $\alpha \cap \beta = d$ .

$$\left. \begin{array}{l} AB \perp \alpha \Rightarrow AB \perp d \\ AC \perp \beta \Rightarrow AC \perp d \end{array} \right\} \Rightarrow d \perp (ABC)$$

$$\Rightarrow \left\{ \begin{array}{l} d \cap (ABC) = \{O\} \\ d \perp OC \\ d \perp OB \end{array} \right\} \Rightarrow m(\widehat{\alpha'\beta'}) = m(\widehat{BOC})$$

$$\left. \begin{array}{l} m(\widehat{ABO}) = 90^\circ \\ m(\widehat{ACO}) = 90^\circ \end{array} \right\} \Rightarrow m(\widehat{BAC}) + m(\widehat{\alpha'\beta'}) = 180^\circ.$$

$$\Rightarrow m(\widehat{\alpha'\beta'}) = 180^\circ - m(\widehat{BAC}) \Rightarrow m(\widehat{BAC}) = 180^\circ - m(\widehat{\alpha'\beta'})$$

Let  $A \in \text{int.}(\widehat{\alpha''\beta'})$ . We show the same way that

$$\left. \begin{array}{l} m(\widehat{BAC}) = 180^\circ - m(\widehat{\alpha''\beta'}) \\ m(\widehat{\alpha''\beta'}) = 180^\circ - m(\widehat{\alpha'\beta'}) \end{array} \right\} \Rightarrow m(\widehat{BAC}) = 180^\circ - 180^\circ + m(\widehat{\alpha'\beta'}) = m(\widehat{\alpha'\beta'}).$$

$$\text{If } A \in \text{int.}(\widehat{\alpha''\beta''}) \Rightarrow m(\widehat{BAC}) = 180^\circ - m(\widehat{\alpha''\beta''}).$$

$$\text{If } A \in \text{int.}(\widehat{\alpha'\beta''}) \Rightarrow m(\widehat{BAC}) = 180^\circ - m(\widehat{\alpha'\beta''}).$$

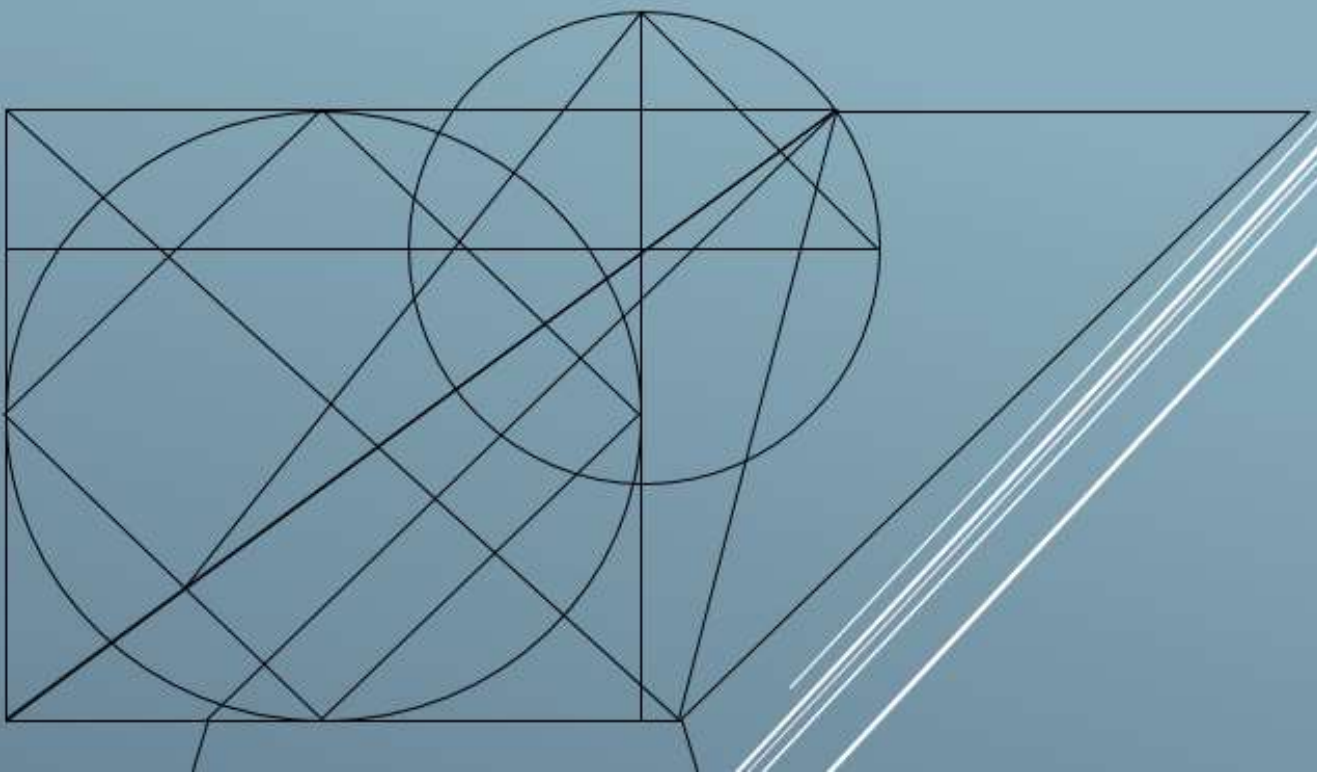

This book is a translation from Romanian of "Probleme Compilate și Rezolvate de Geometrie și Trigonometrie" (University of Kishinev Press, Kishinev, 169 p., 1998), and includes problems of 2D and 3D Euclidean geometry plus trigonometry, compiled and solved from the Romanian Textbooks for 9th and 10th grade students, in the period 1981-1988, when I was a professor of mathematics at the "Petrașe Poenaru" National College in Balcești, Valcea (Romania), Lycée Sidi El Hassan Lyoussi in Sefrou (Morocco), then at the "Nicolae Balcescu" National College in Craiova and Dragotesti General School (Romania), but also I did intensive private tutoring for students preparing their university entrance examination. After that, I have escaped in Turkey in September 1988 and lived in a political refugee camp in Istanbul and Ankara, and in March 1990 I immigrated to United States. The degree of difficulties of the problems is from easy and medium to hard. The solutions of the problems are at the end of each chapter. One can navigate back and forth from the text of the problem to its solution using bookmarks. The book is especially a didactical material for the mathematical students and instructors.

The Author

